

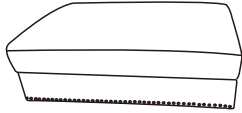

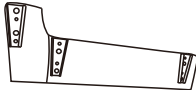

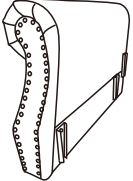
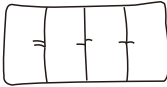
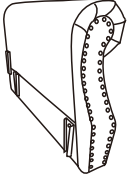

ASSEMBLY INSTRUCTION

887 SOFA

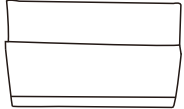
	Part Image	Part Name	QTY		Part Image	Part Name	QTY
A		Seat	2	E		Middle Board	1
B		Right Armrest	1	F		Back cushion	2
B		Left Armrest	1	G		Legs	6
C		Backrest	2	H		Non-slip Gasket	6
D		Crossbar	2	I		Screws	4
				J		Allen Key	1

STEP1 Connect partA with partE

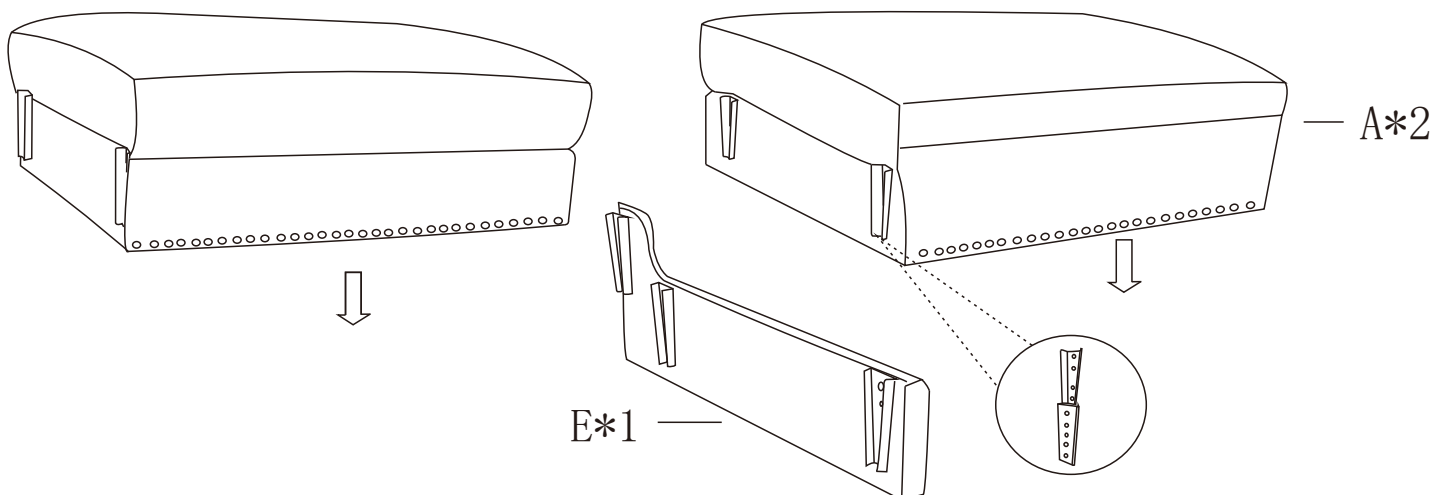
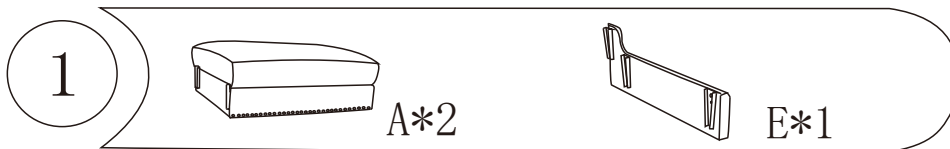

Put the left armrest and the right armrest on the sides of the seat cushion.

STEP2

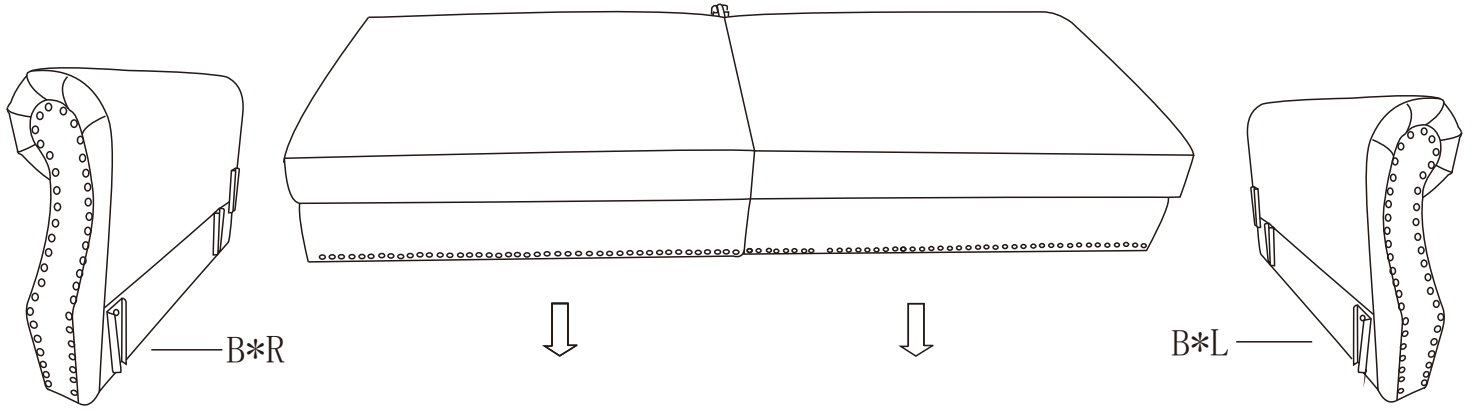
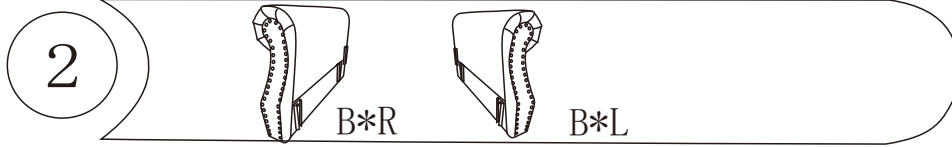

Install six legs G using part H at the bottom of the sofa

STEP3

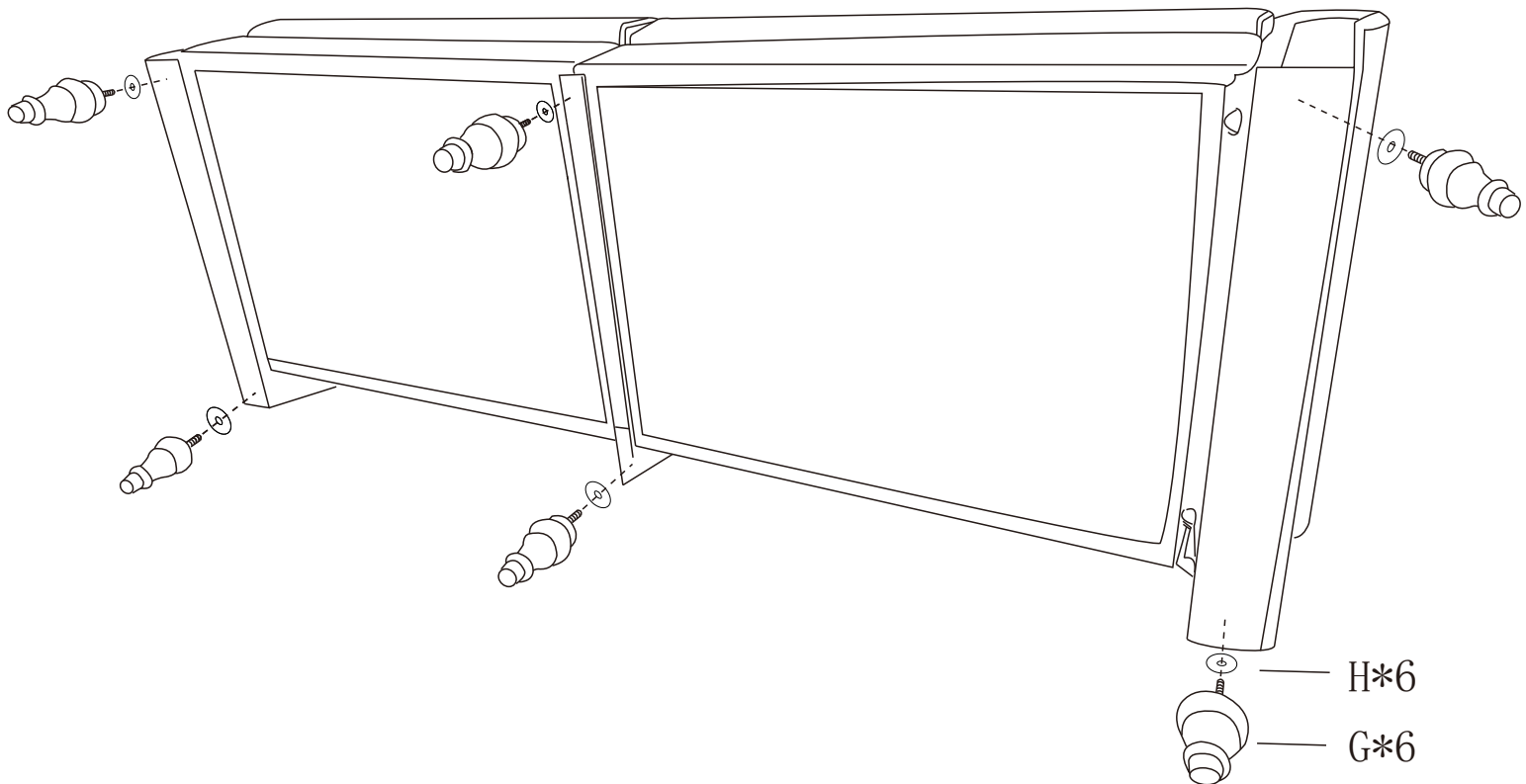
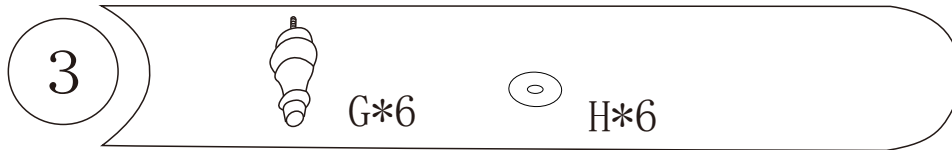

Fix the two crossbars D onto the two C backrest with screws I respectively.

STEP 4

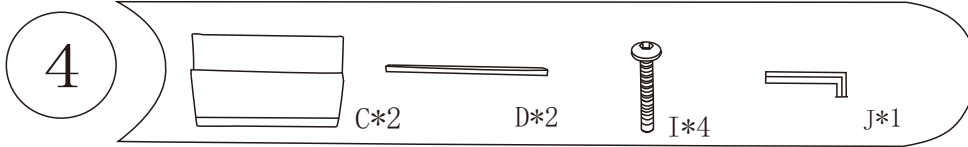

Insert the assembled backrest into the back of the sofa separately

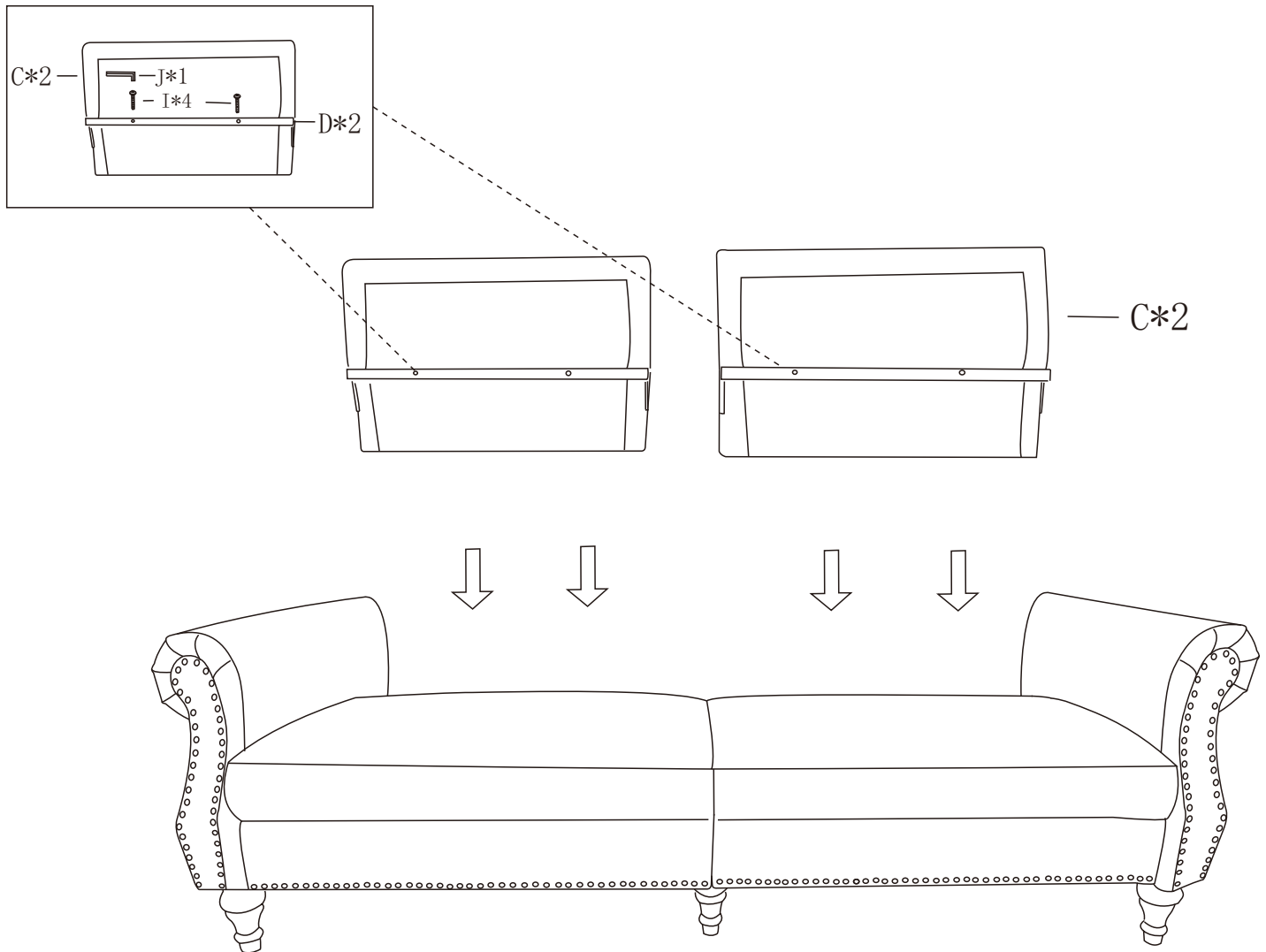

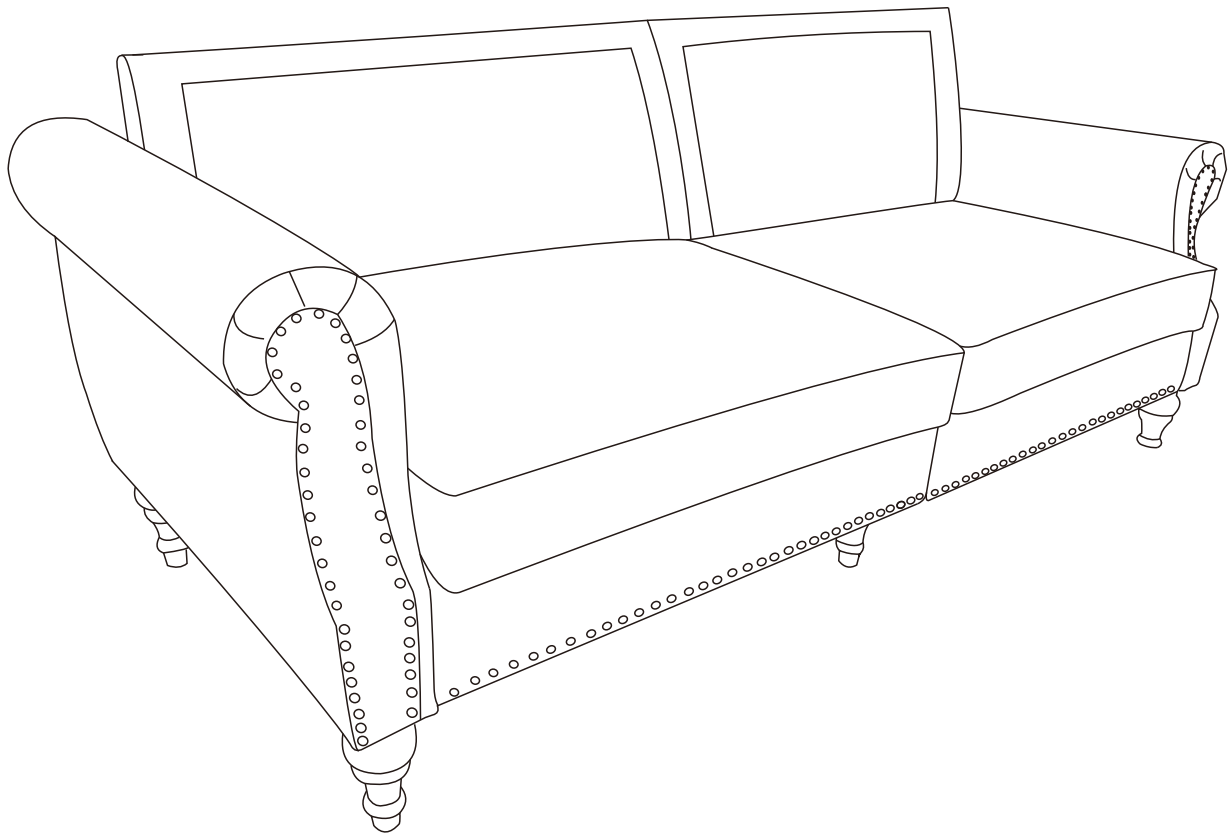

STEP5

