

Upper Twin Bed

This set is included 3 boxes if don't receive full 3 boxes please contact our customer service team

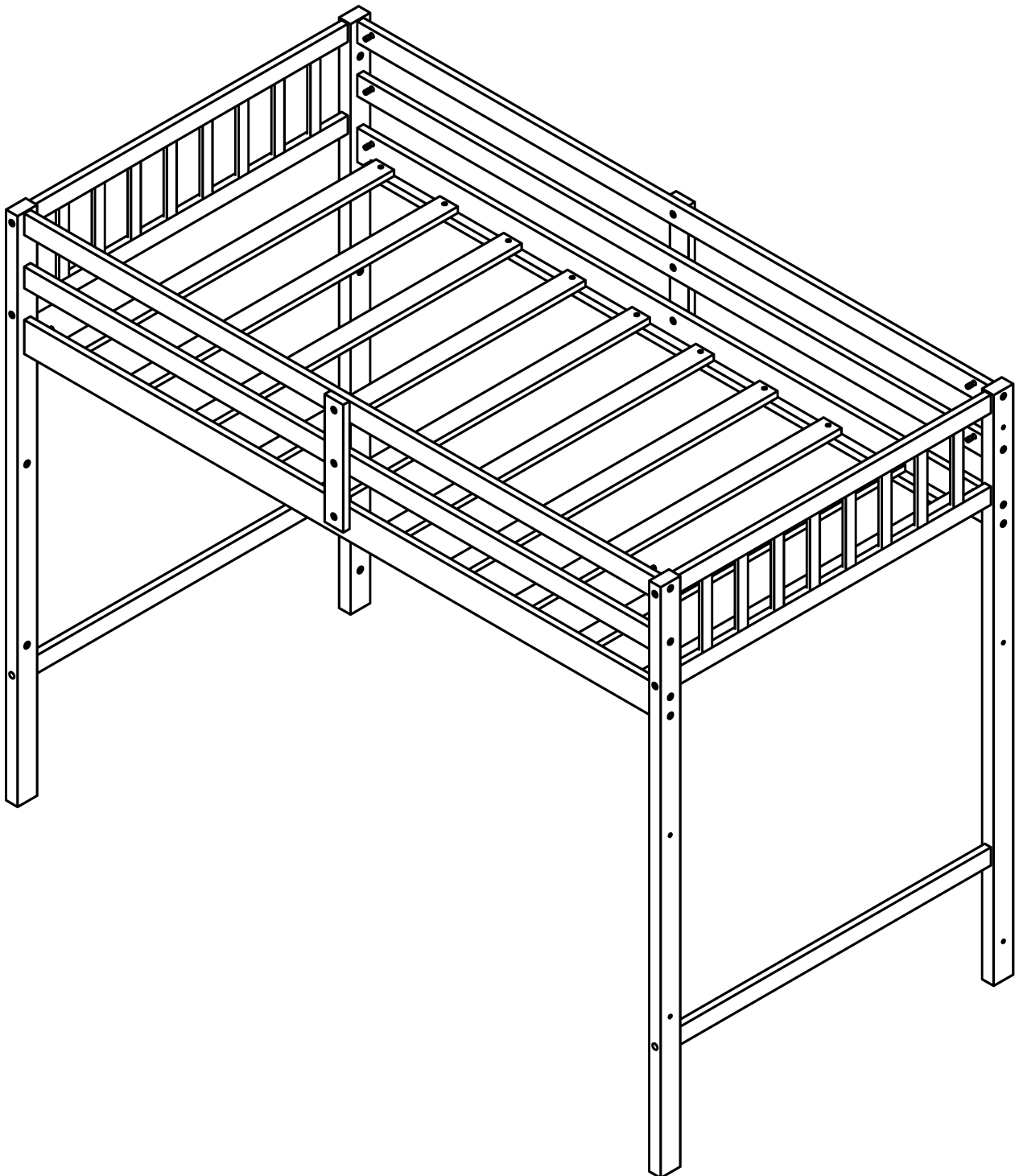

PART LIST

1

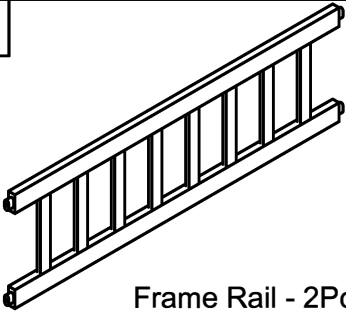

Frame Rail - 2Pcs

2



Legs headboard (L) - 1pc

3



Legs headboard (R) - 1pc

4



Legs footboard (L) - 1pc

5



Legs footboard (R) - 1pc

6

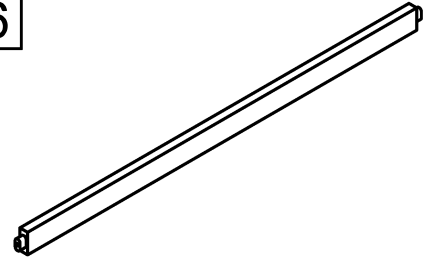

Support Rail (L&R) - 2pc

7

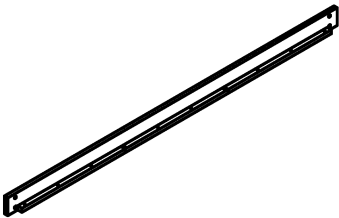

Side rails - 2Pcs

8



Vertical guardrail-2pcs

9

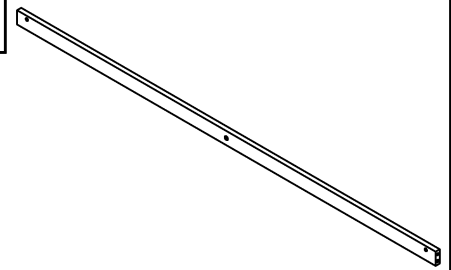

Long guardrail (Back)-4pcs

10

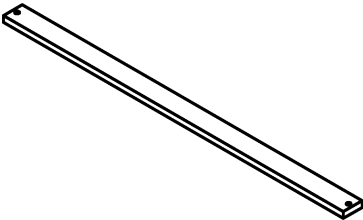

Slats - 10Pcs

HARDWARE LIST

A



M4 x 30mm
Wood Screws - 20Pcs

B

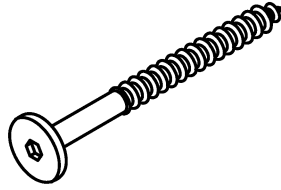

Ø1/ 4x 70 mm
Hexagonal bolts catch Wood-12Pcs

C

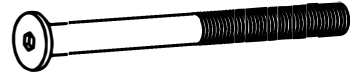

Ø1/ 4x 100 mm
Hex-Head bolts - 8Pcs

D



Ø10 x 40mm
Dowles - 12Pcs

E



Ø1/ 4x 13mm
Cross nuts - 16Pcs

F

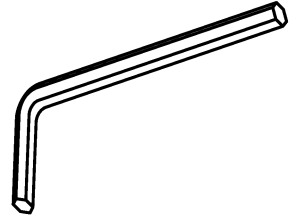

Allen Key - 1Pc

G

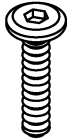

Ø1/ 4"x 25 mm
Hex-Head bolts - 6pcs

H



Ø1/ 4"x 15 mm
Canopy head though - 6pcs

I

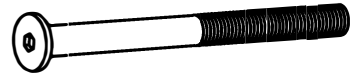

Ø1/ 4x 80 mm
Hex-Head bolts - 8Pcs

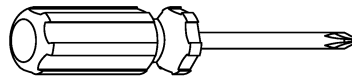

Assembly Tools Required (Not Included)

**PLEASE BE CAREFUL DO NOT DAMAGE THE HOLE
POSITION WHEN YOU USE POWER TOOLS!**

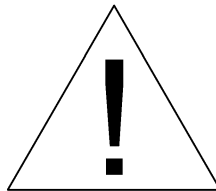

STEP 1

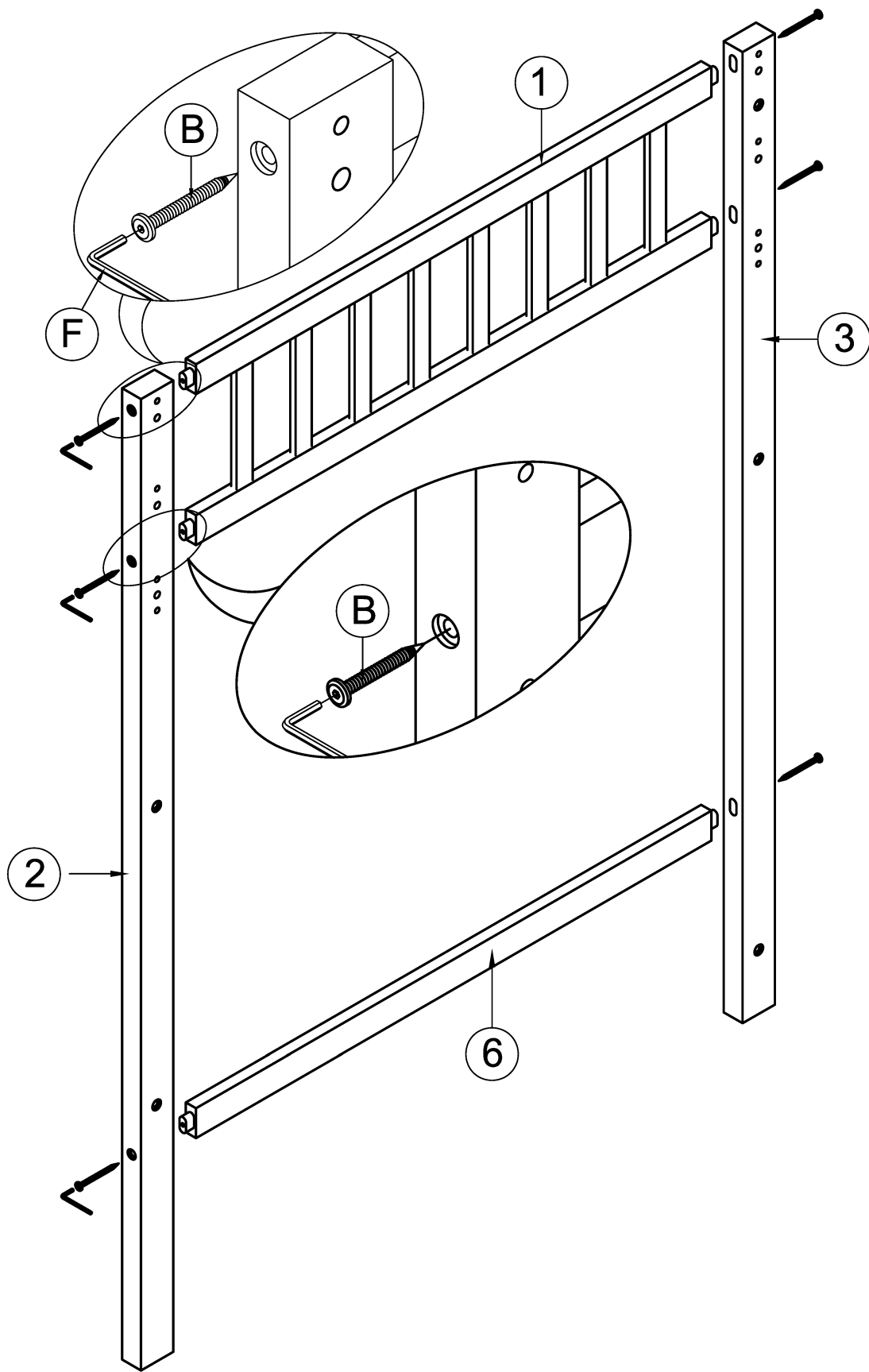
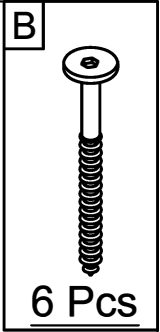





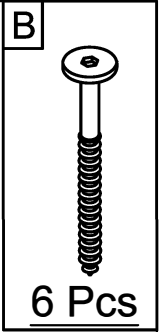
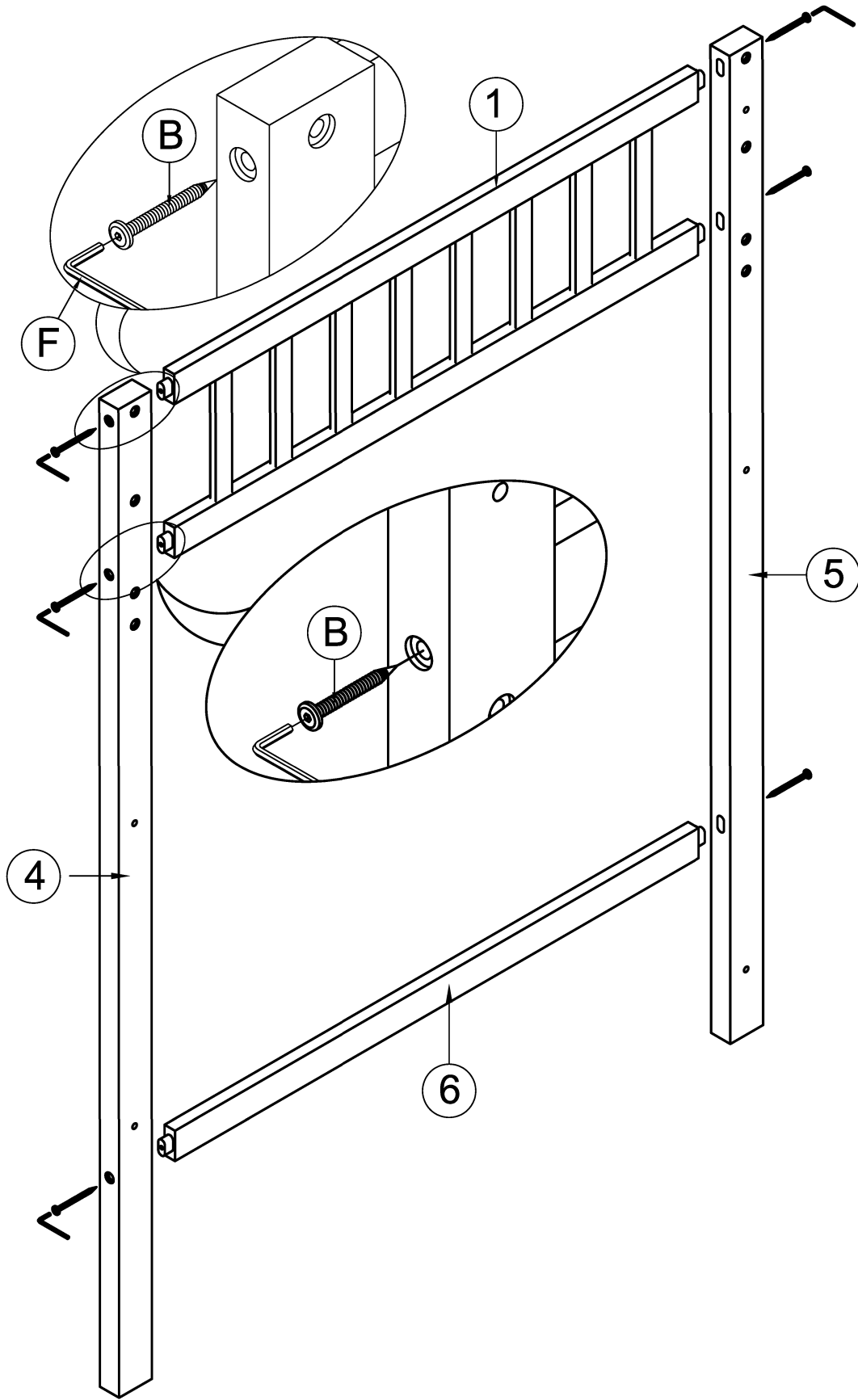

HEADBOARD

STEP 2



FOOTBOARD

STEP 3

<p>F</p>  <p>1pcs</p>	<p>C</p>  <p>8pcs</p>	<p>E</p>  <p>16pcs</p>	<p>D</p>  <p>12pcs</p>
<p>I</p>  <p>8pcs</p>	<p>G</p>  <p>6pcs</p>	<p>H</p>  <p>6pcs</p>	

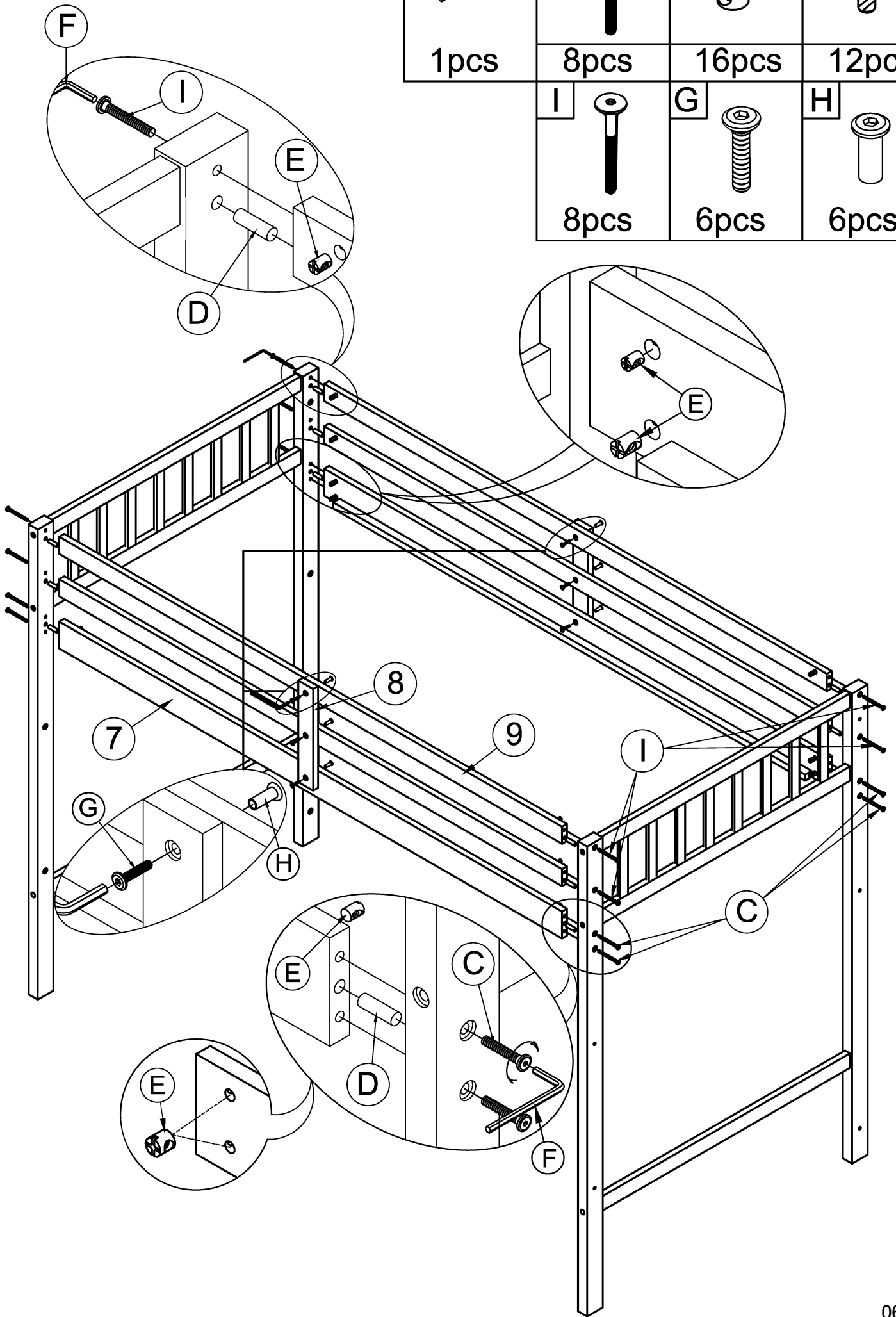

STEP 4

A

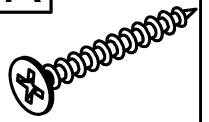

20pcs

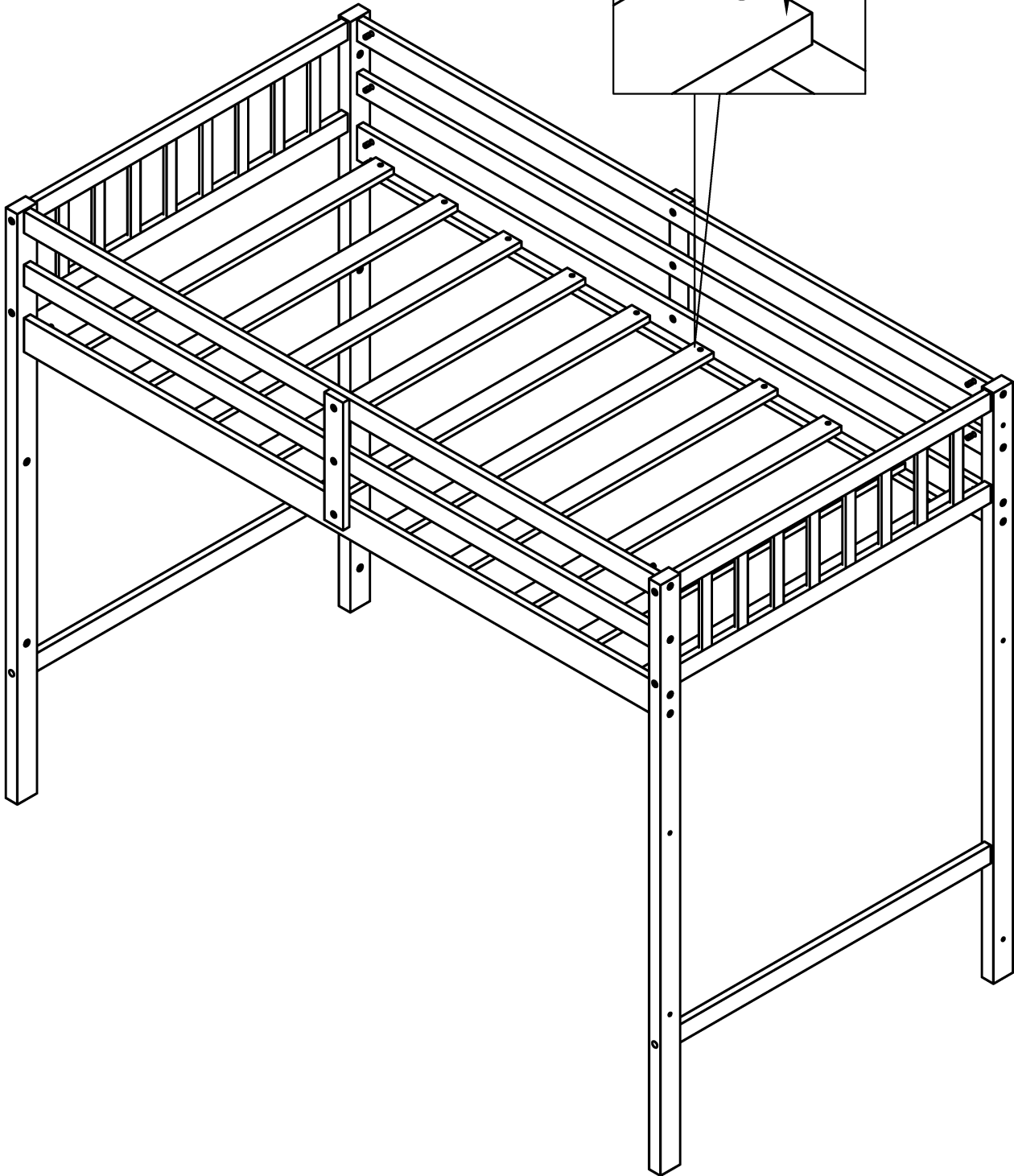
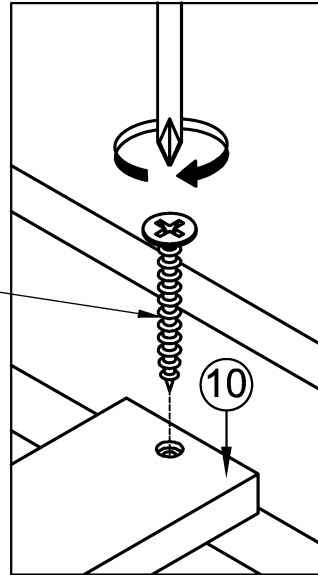

Please complete screw all slats to siderail before out the mattress on and using