

CS1905-30

Specifications & Dimension

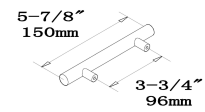

Handle's Dimension

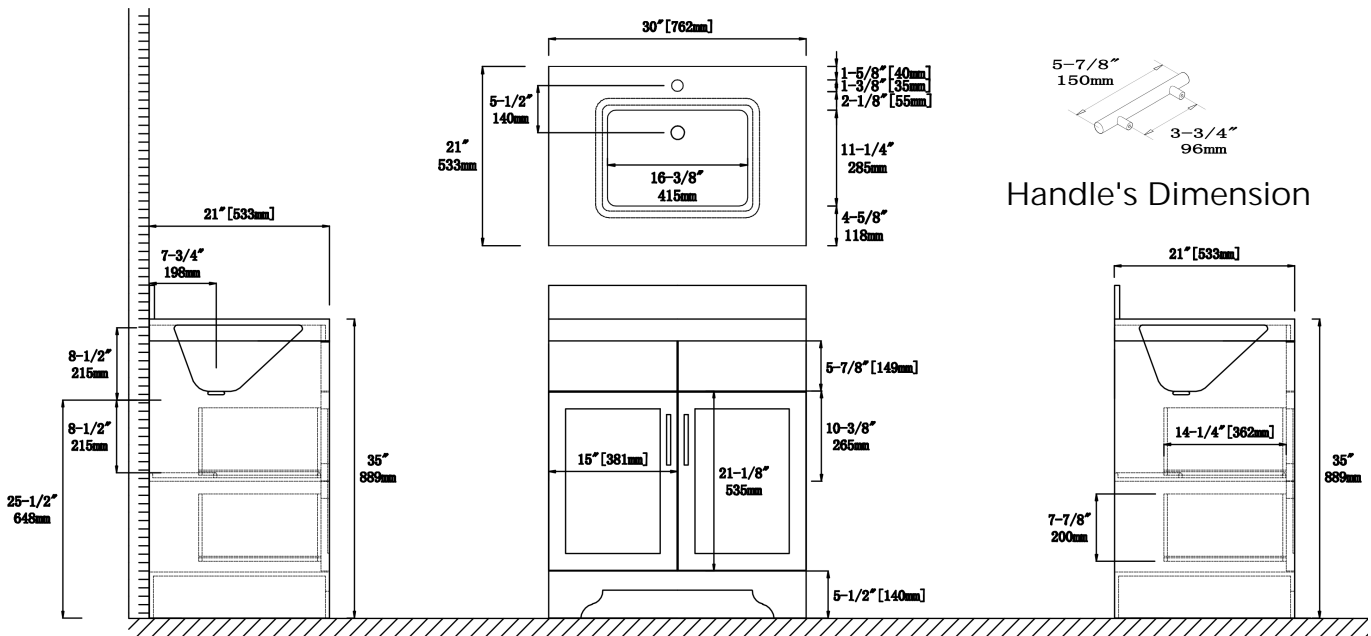
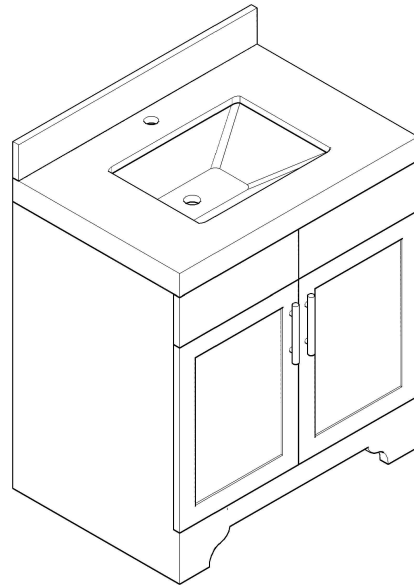