

# ASSEMBLY INSTRUCTIONS

- Thank you for purchasing and using our sofa products.
- There are two combinations of sofas. Please refer to the list of corresponding parts and assembly methods according to the actual purchase.

## ATTENTION:

- The product is away from heat and fire sources.
- Keep the product away from sharp objects.
- Do not use strong detergents or polishes such as detergents, solvents, abrasives, spray bags or leather cleaners to clean products.
- Use colorless gentle soap to mix warm water (mix 1:10 percent of soap and water) or professional cleaning products to clean the sofa.
- Do not place furniture in direct sunlight, the product may fade over time.
- Some parts of the product have been compressed. Please open the compression bag after receiving the product, make the parts fluffy, and it will slowly return to their original state within 72 hours.

# Combination A

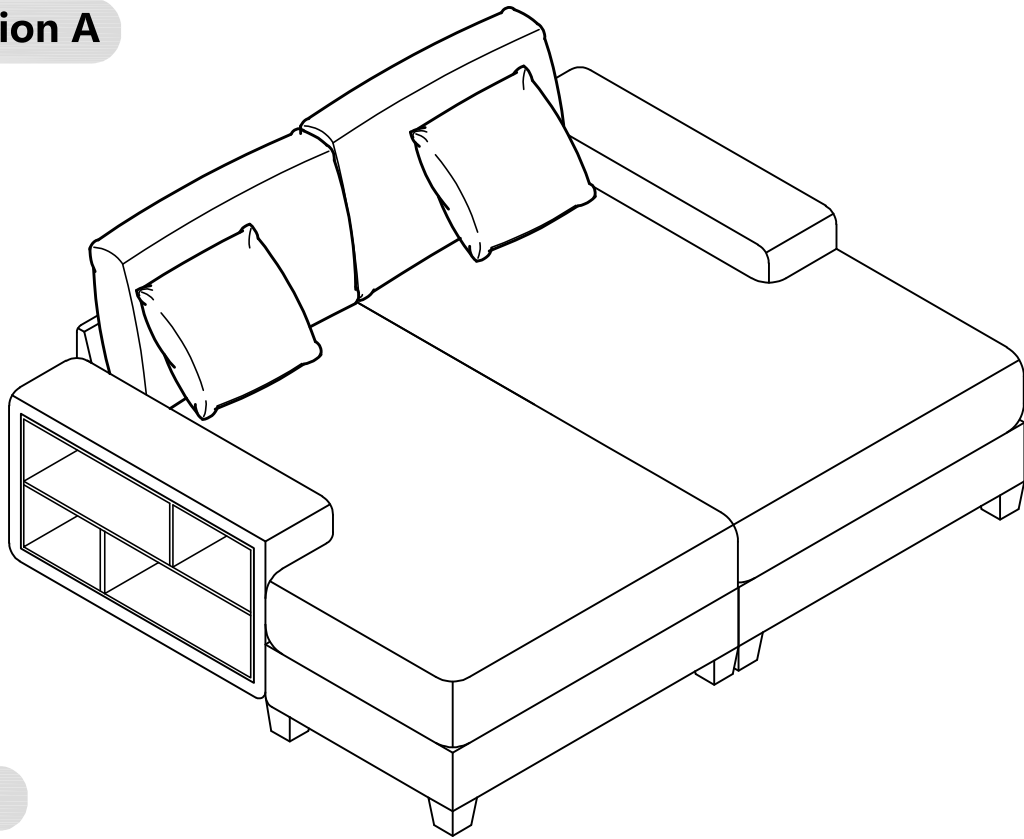

## Parts list

**(A1) Left armrest**

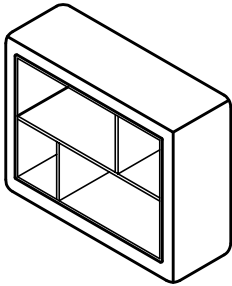

**1pcs**

**(A2) Right armrest**

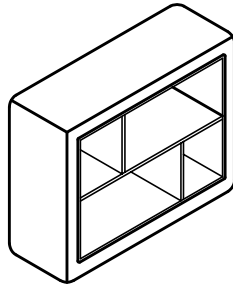

**1pcs**

**(B1) Back shelf**

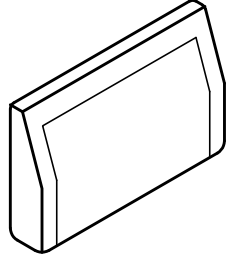

**2pcs**

**(B2) Left armrest single seat frame**

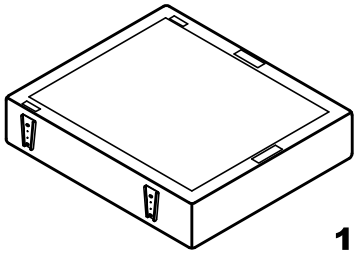

**1pcs**

**(B3) Right armrest single seat frame**

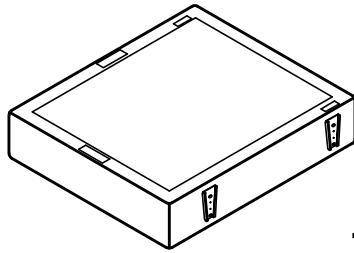

**1pcs**

**(B4) Footstool cradle**

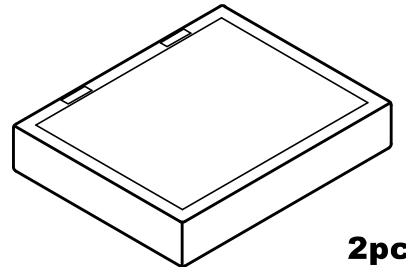

**2pcs**

**(C1) Cushion**

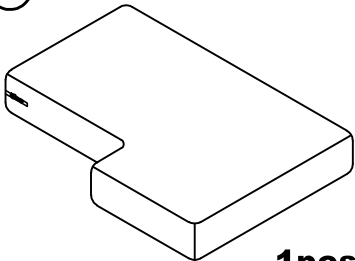

**1pcs**

**(C2) Cushion**

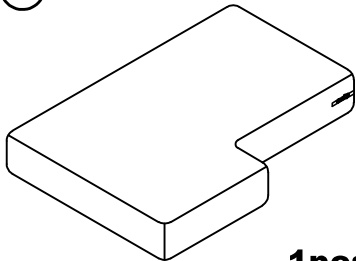

**1pcs**

**(C3) Backpack**

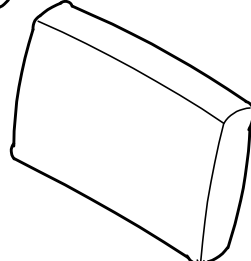

**2pcs**

**(C4) Throw pillow**

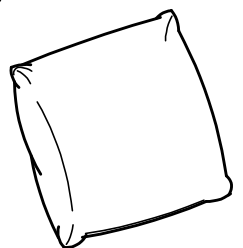

**2pcs**

**(E1) Plastic feet**

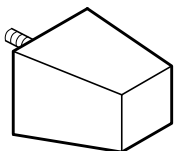

**16pcs**

**(E2) Inserts**

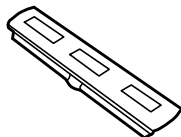

**4pcs**

**(E3) Non-slip gasket**

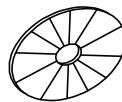

**16pcs**

**(E4) Metal hooks**

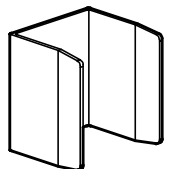

**3pcs**

## Combination B

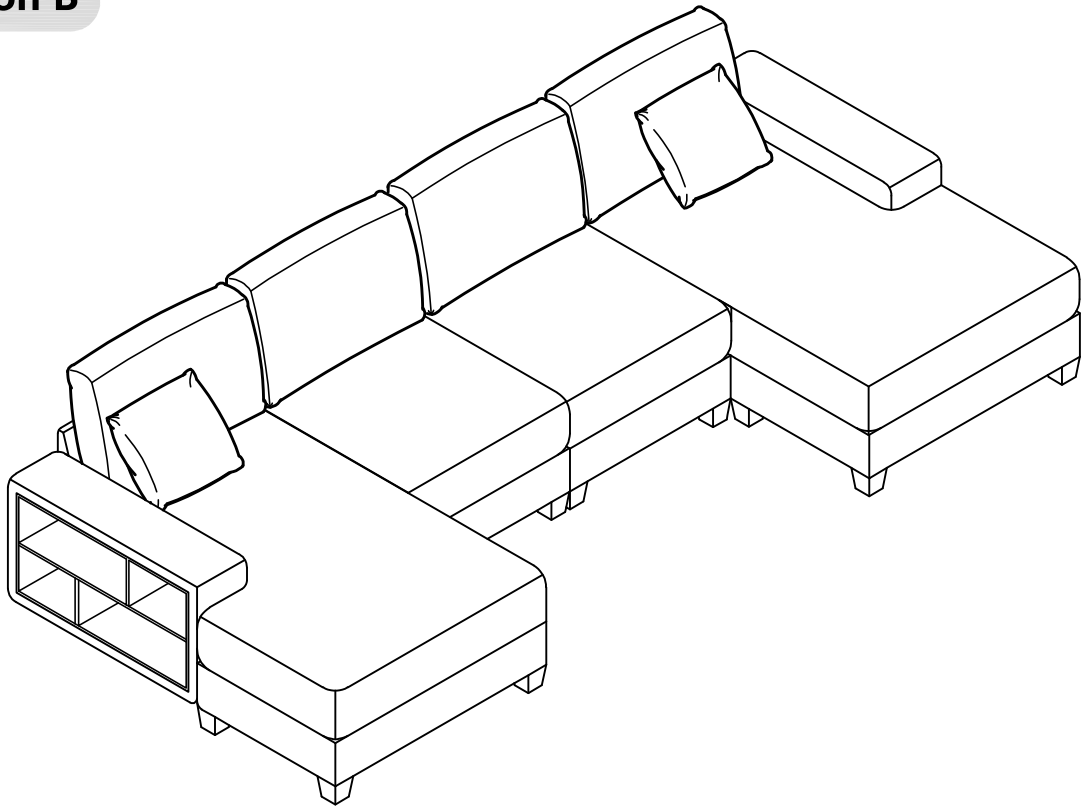

### Parts list

This is a new product component added on the basis of combination A.

**(B1)** Back shelf

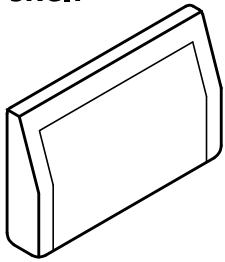

2pcs

**(B5)** Single seating frame

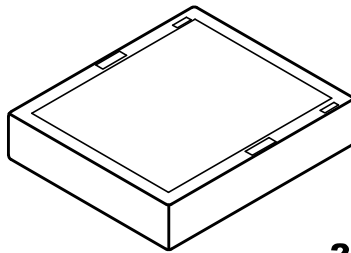

2pcs

**(C3)** Backpack

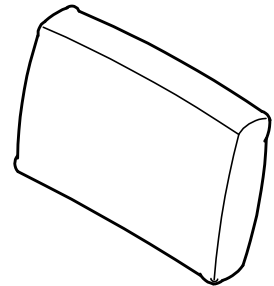

2pcs

**(C5)** Cushion

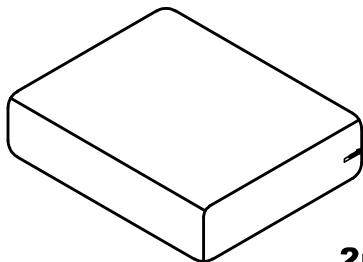

2pcs

**(E1)** Plastic feet

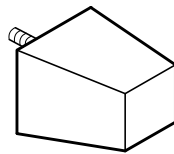

8pcs

**(E2)** Inserts

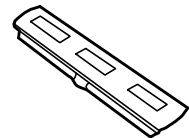

4pcs

**(E3)** Non-slip gasket

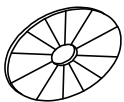

8pcs

**(E4)** Metal hooks

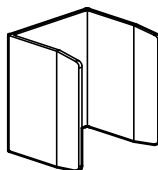

2pcs

**Combination A packing list**

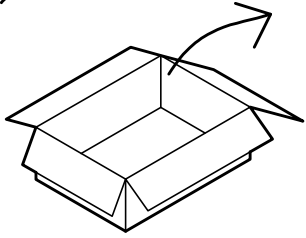

**Handrail**

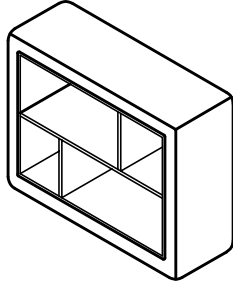

**A1\*1Pcs**

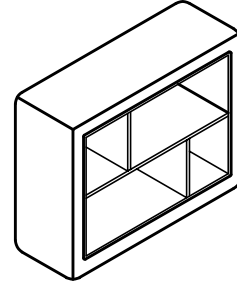

**A2\*1Pcs**

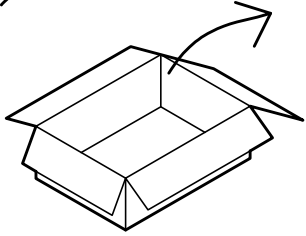

**Handrail for one person**

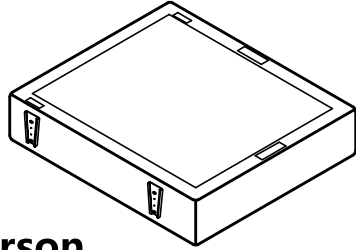

**B2\*1Pcs**

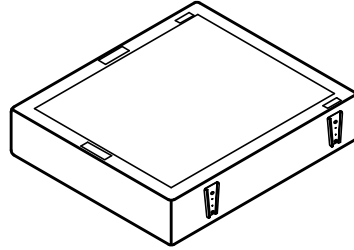

**B3\*1Pcs**

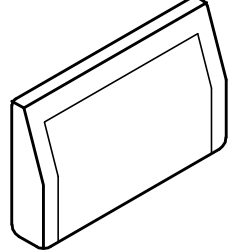

**B1\*2Pcs**

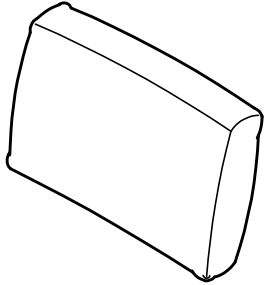

**C3\*2Pcs**

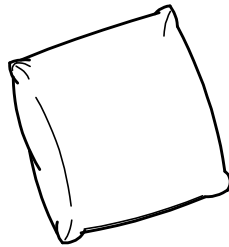

**C4\*2Pcs**

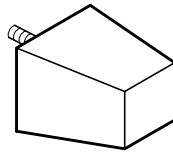

**E1\*8Pcs**

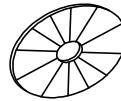

**E3\*8Pcs**

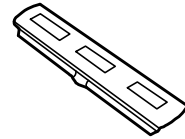

**E2\*4Pcs**

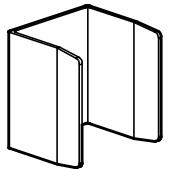

**E4\*3Pcs**

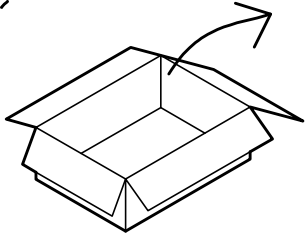

**Footstool**

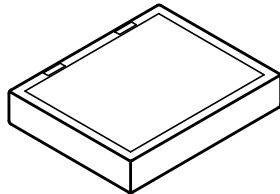

**B4\*2Pcs**

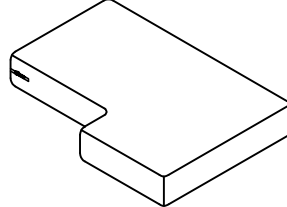

**C1\*1Pcs**

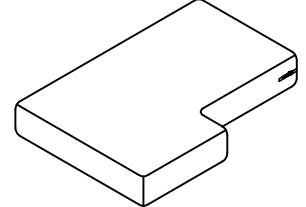

**C2\*1Pcs**

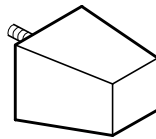

**E1\*8Pcs**

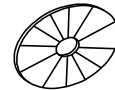

**E3\*8Pcs**

**Combination B packing list**

This is a new product packaging on the basis of combination A

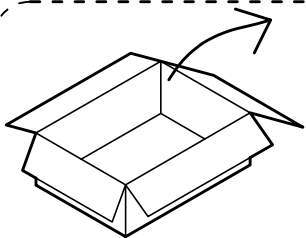

**Single seat**

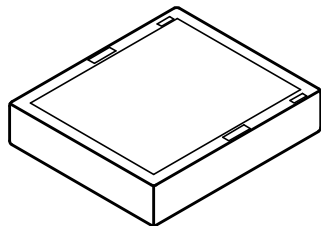

**B5\*2Pcs**

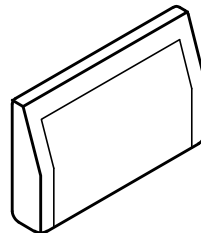

**B1\*2Pcs**

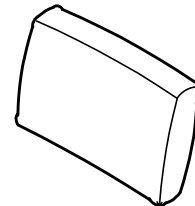

**C3\*2Pcs**

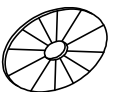

**E3\*8Pcs**

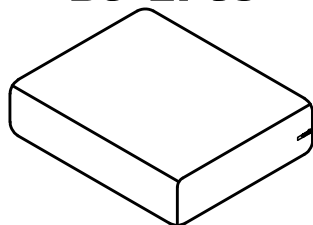

**C5\*2Pcs**

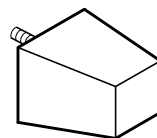

**E1\*8Pcs**

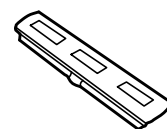



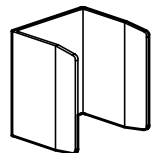

**E2\*4Pcs**



**E4\*2Pcs**

# Combination A assembly steps



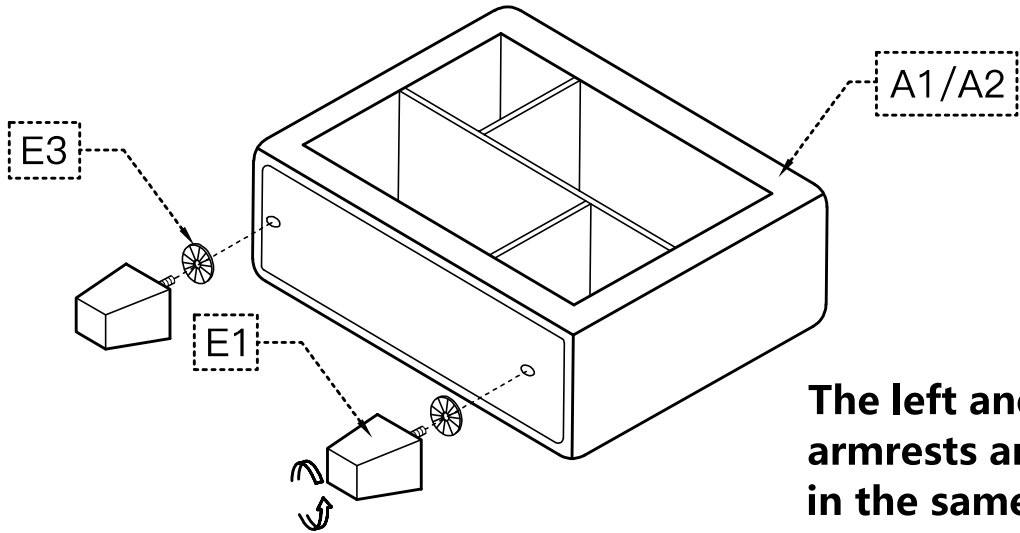

## STEP 1

A1		x1
A2		x1
E1		x4
E3		x4



The left and right armrests are installed in the same way.

## STEP 2

B2		x1
B3		x1
E1		x4
E3		x4

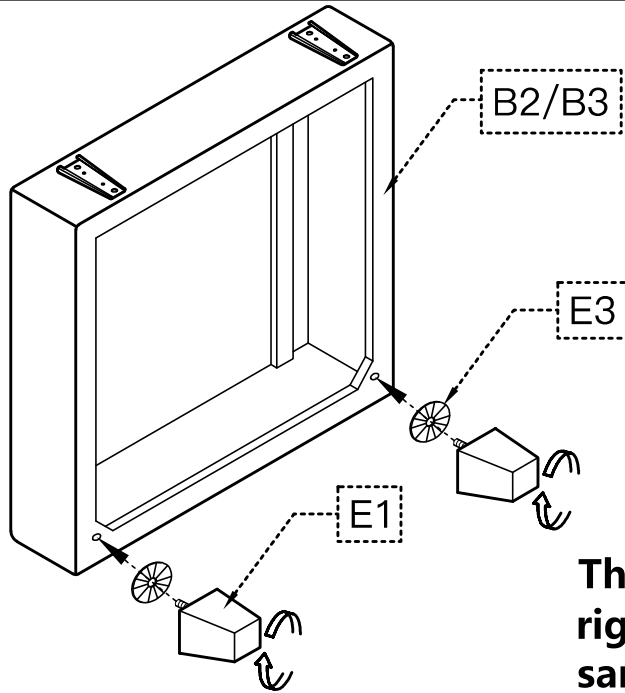

The single seats of the left and right armrests are installed in the same way.

## STEP 3

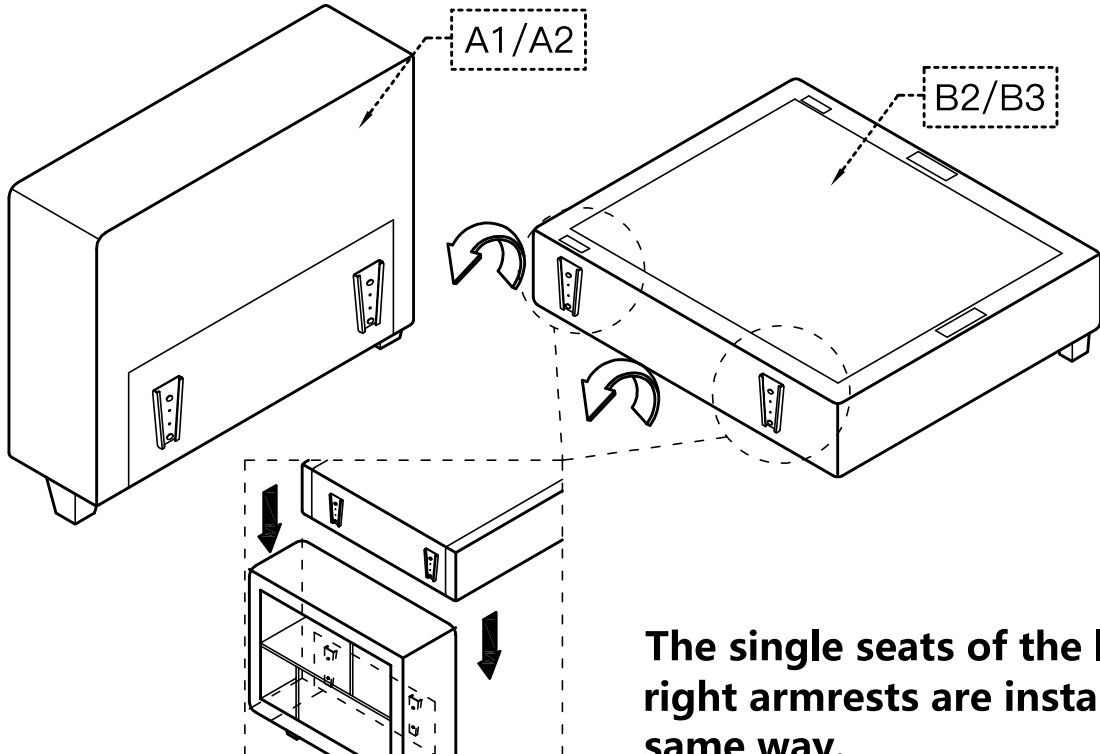

The single seats of the left and right armrests are installed in the same way.

# Combination A assembly steps

## STEP 4

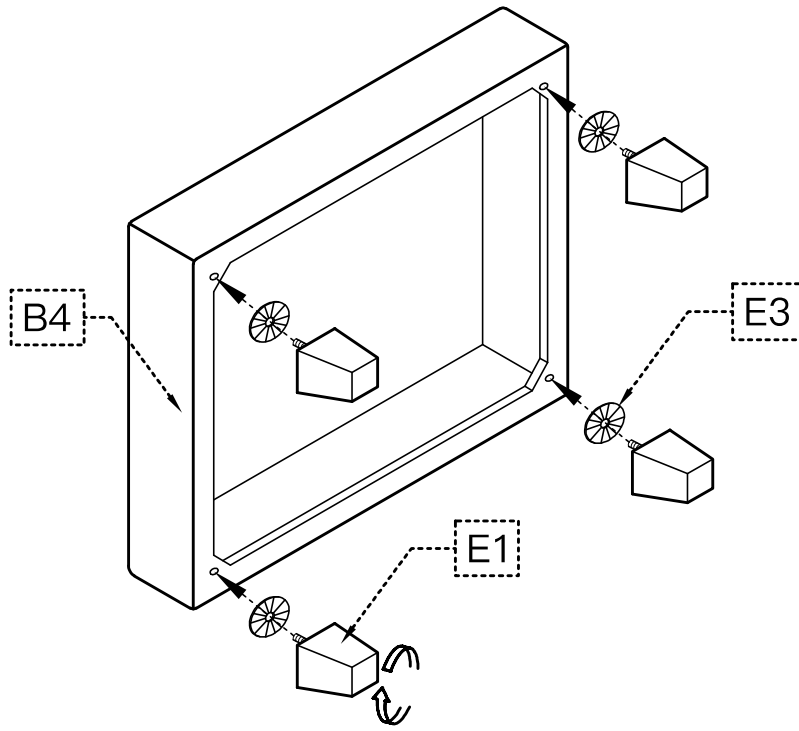

B4		x2
E1		x8
E3		x8

## STEP 5

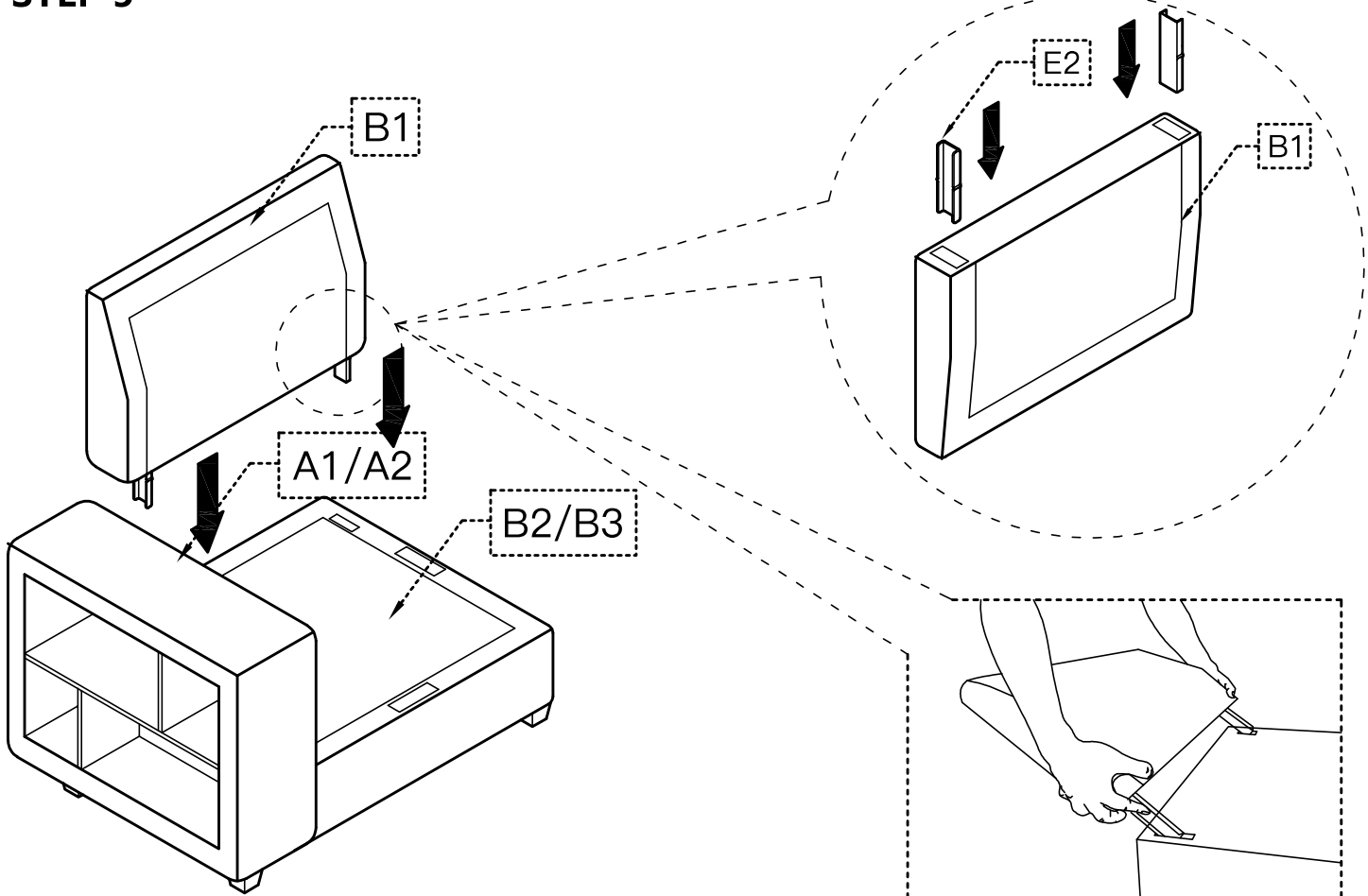

B1		x2
E2		x4

**Install the connector under the backrest, and then insert it at the corresponding position at an angle of 45°. The left and right armrests are installed in the same way.**

## Combination A assembly steps

### STEP 6

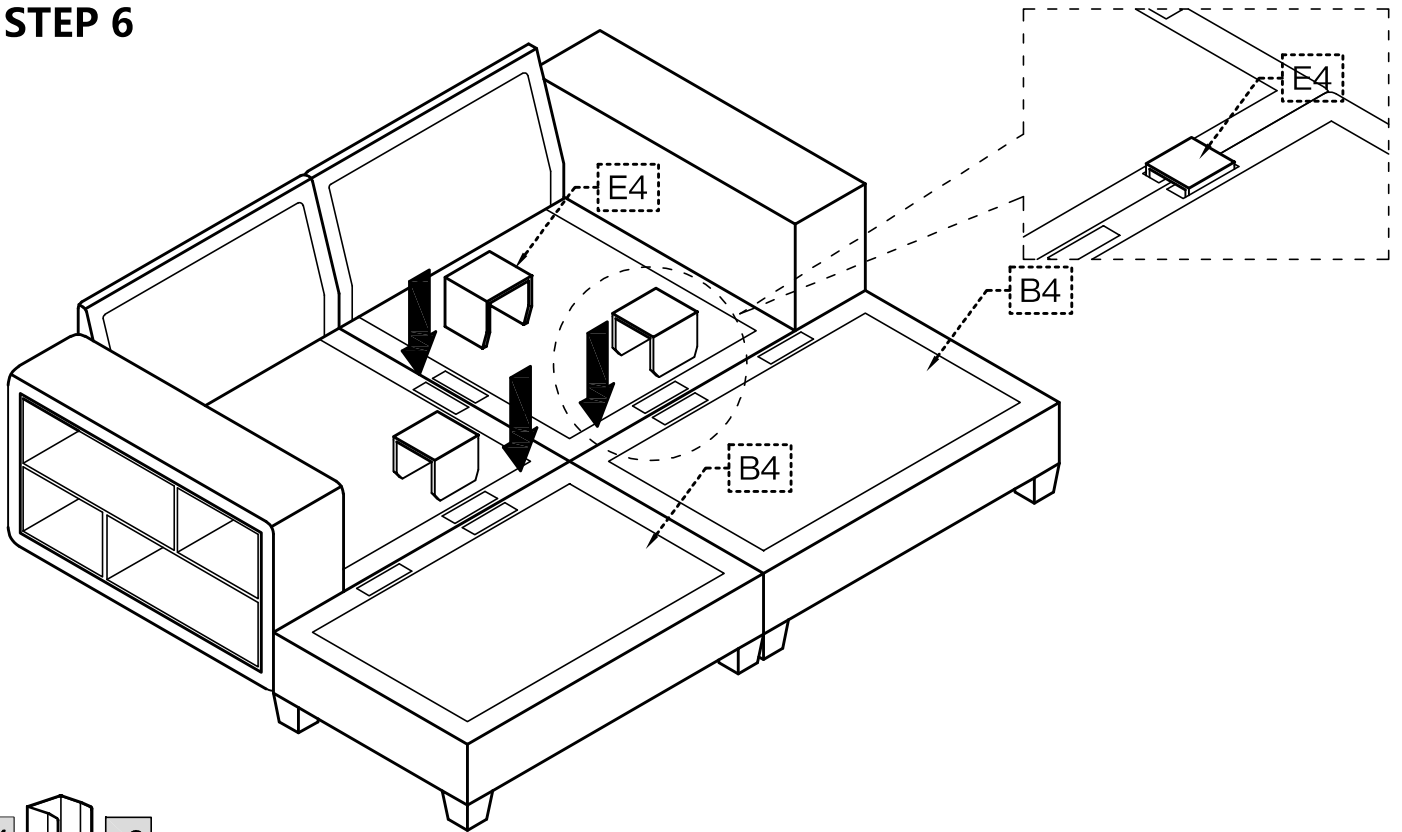

### STEP 7

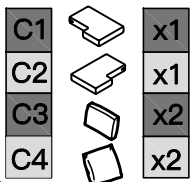
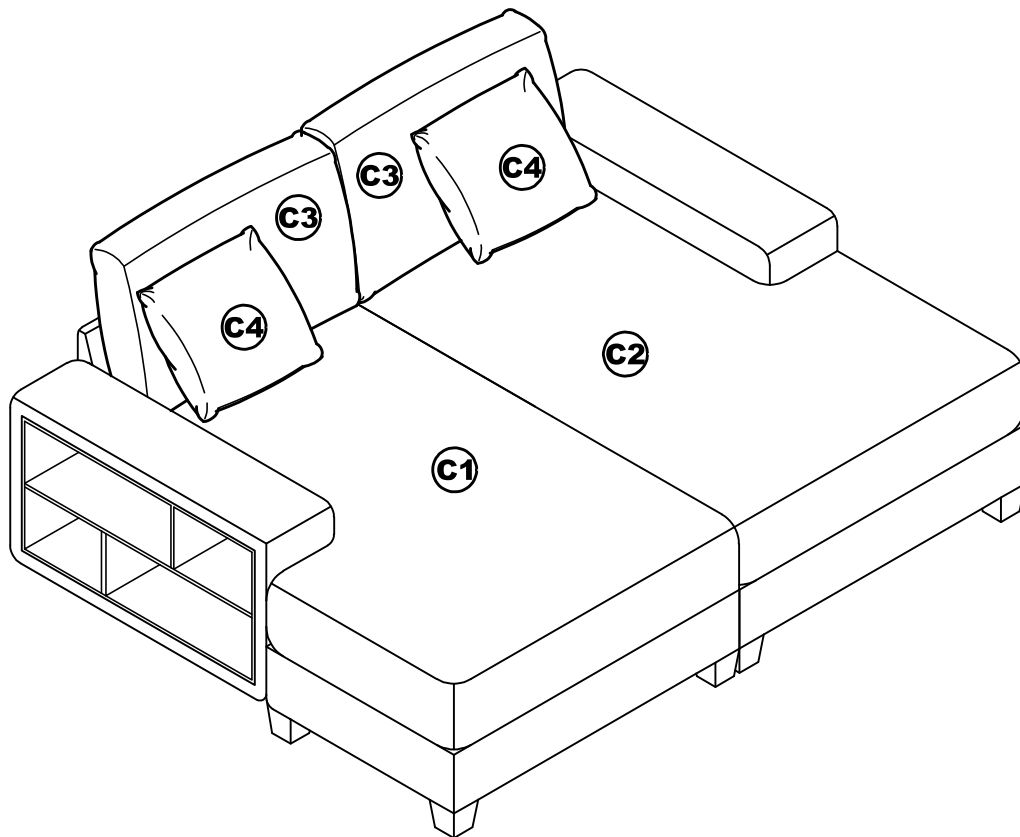

The installation of the combination A sofa is complete. If you purchased a combination B sofa, please follow the next steps to continue the installation

# Combination A assembly steps

## STEP 8

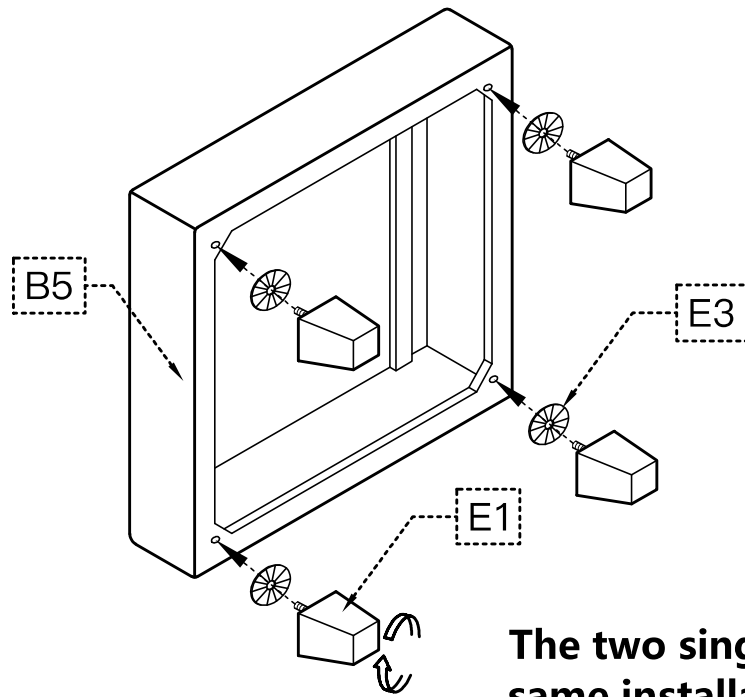

B5		x2
E1		x8
E3		x8

The two single seats adopt the same installation method.

## STEP 9

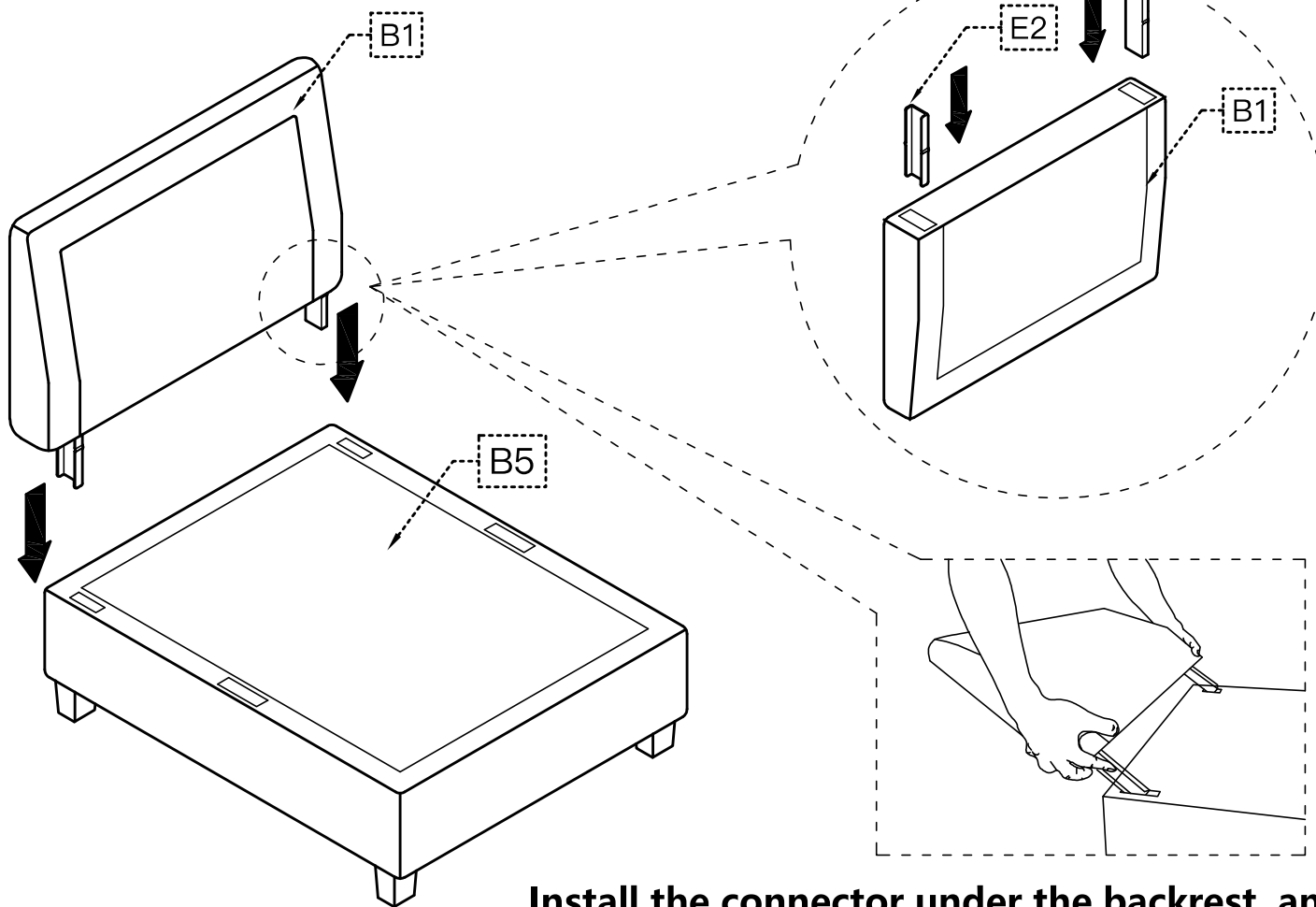

Install the connector under the backrest, and then insert it at the corresponding position at an angle of 45°. The left and right armrests are installed in the same way.

B1		x2
E2		x4

# Combination B assembly steps

## STEP 10

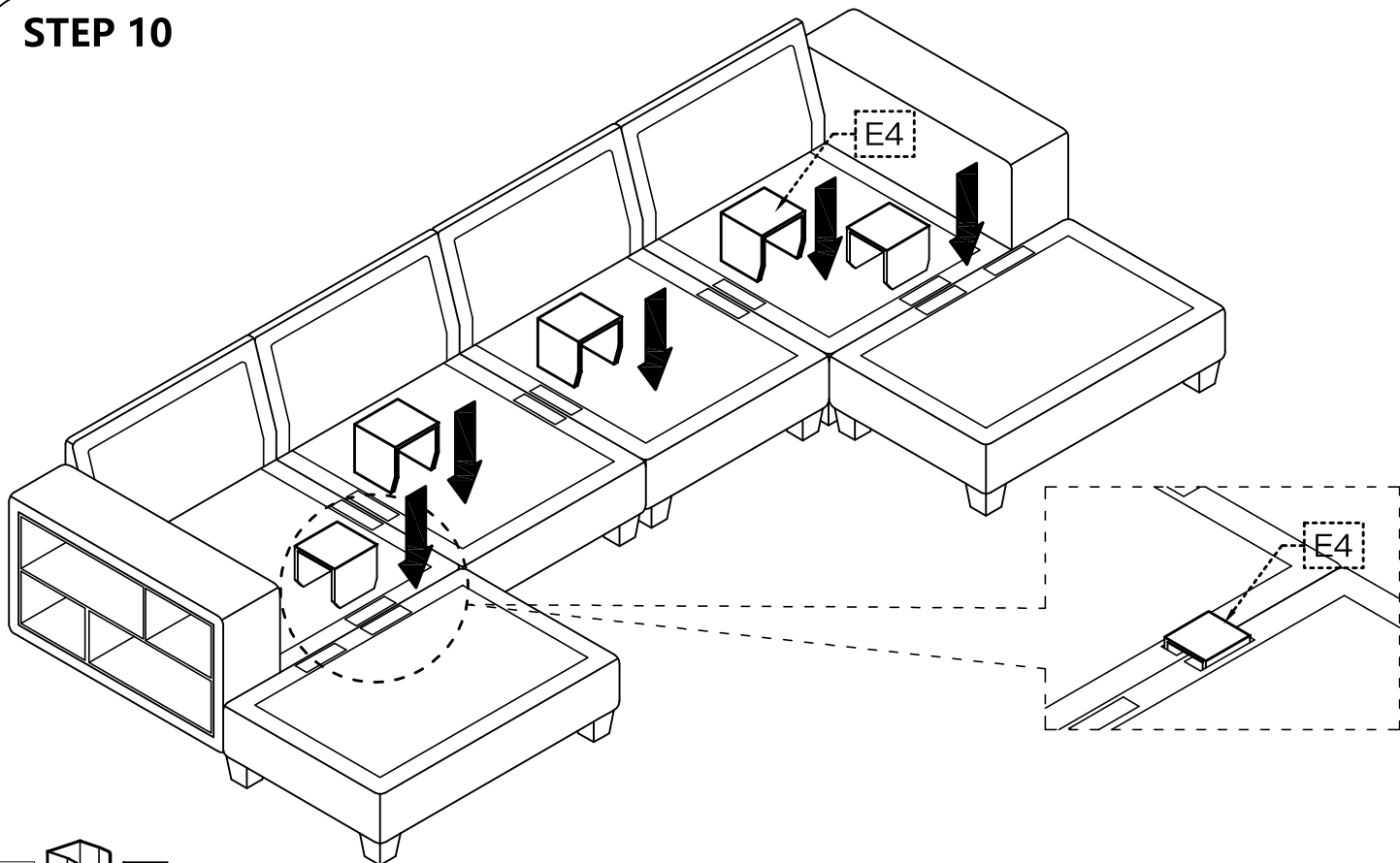

## STEP 11

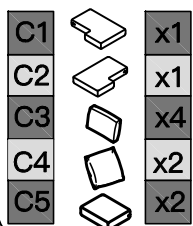
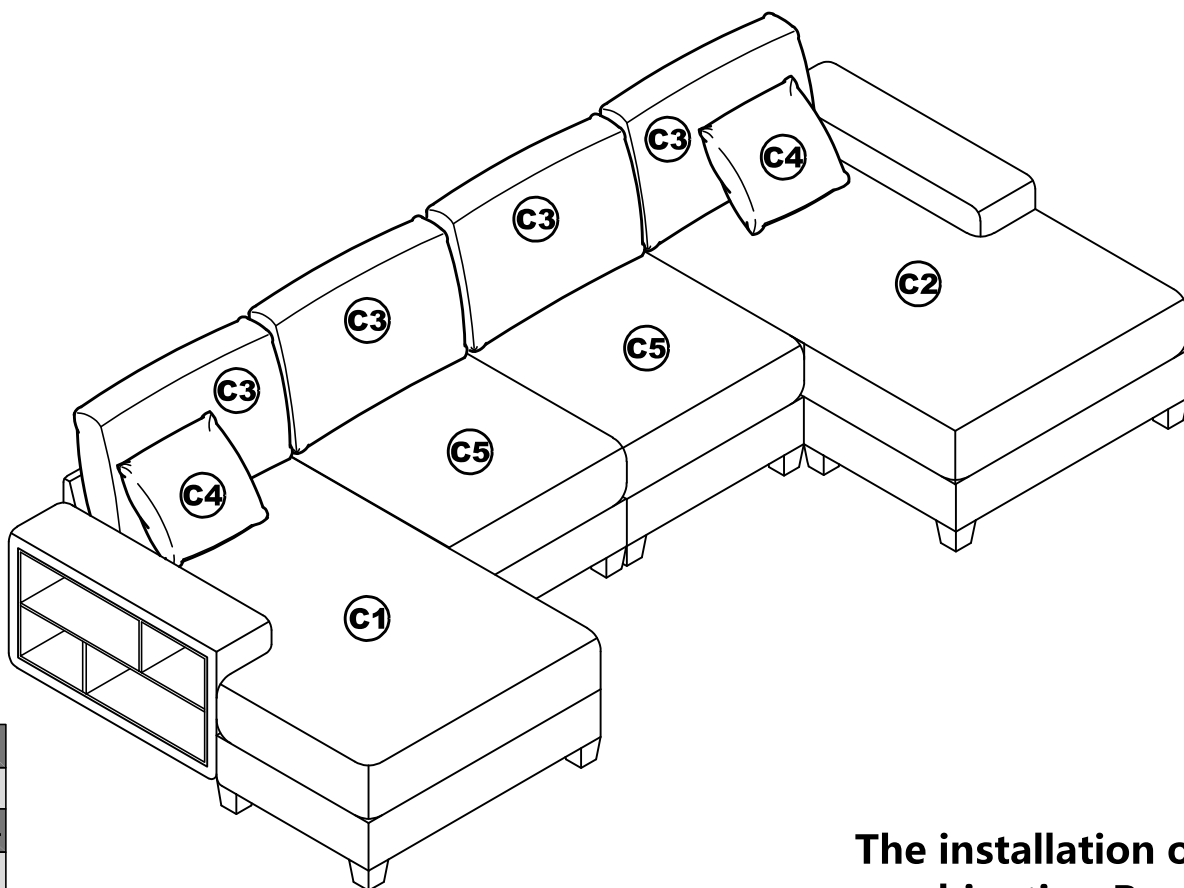

The installation of the combination B sofa is completed.