

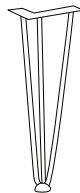

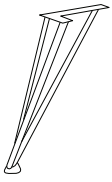

Assembly instructions and safety information:

- Tools:** A circle containing an Allen key and a wrench, with a crossed-out power drill icon next to it, indicating that a power drill is not required.
- Time:** A clock icon with the text "45'" below it, indicating the estimated assembly time.
- Personnel:** A person icon with the number "2" below it, indicating that two people are required for assembly.
- Warnings:** Two warning triangles (exclamation marks) are present. The top one is connected to the tools section, and the bottom one is connected to the floor mat section.
- Floor Protection:** A circle containing a floor mat with a rectangular object on it, and a crossed-out icon of a rectangular object on a floor without a mat, indicating that a floor mat should be used to protect the floor during assembly.

A x 2

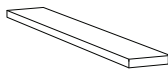
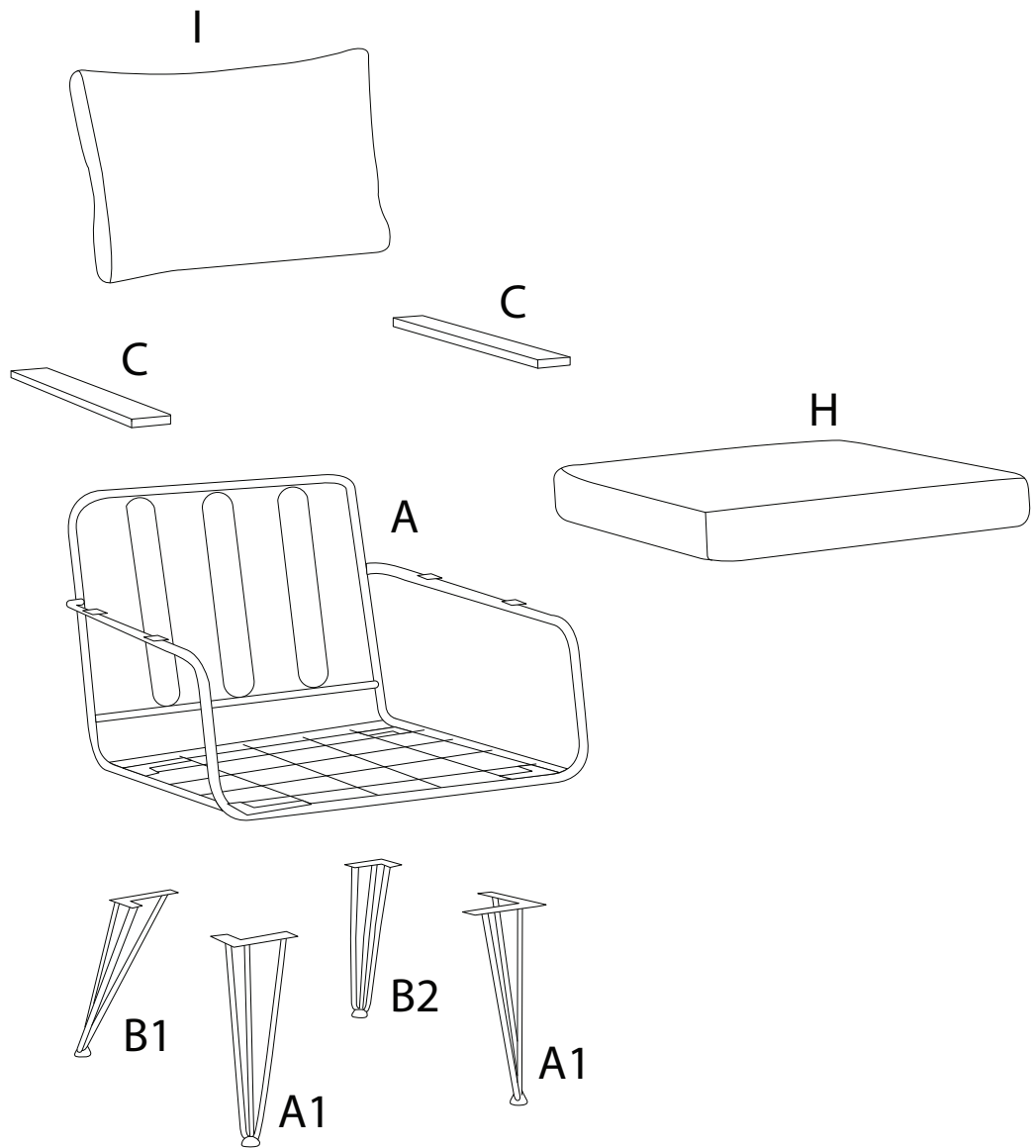
<p>A</p> 	<p>A1</p> 	<p>B1</p> 	<p>B2</p> 	<p>C</p> 
<p>x 1</p>	<p>x 2</p>	<p>x 1</p>	<p>x 1</p>	<p>x 2</p>

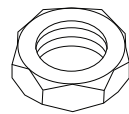
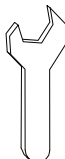
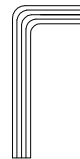
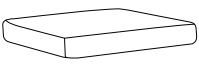
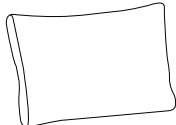

<p>D</p>  <p>M6 x 14</p>	<p>E</p> 	<p>F</p> 	<p>G</p> 	<p>H</p> 	<p>I</p> 
<p>x 20</p>	<p>x 12</p>	<p>x 1</p>	<p>x 1</p>	<p>x 1</p>	<p>x 1</p>

1

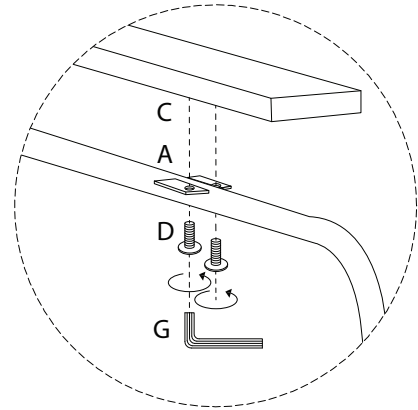
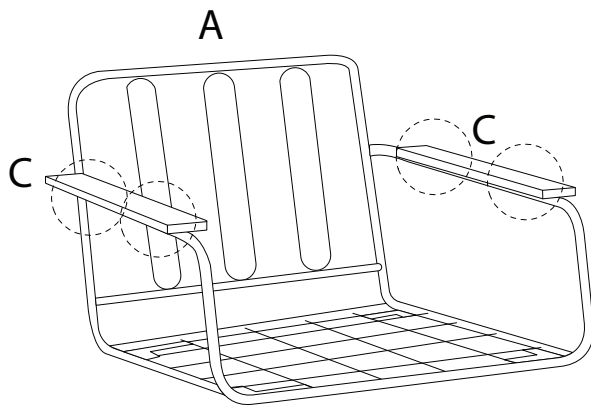
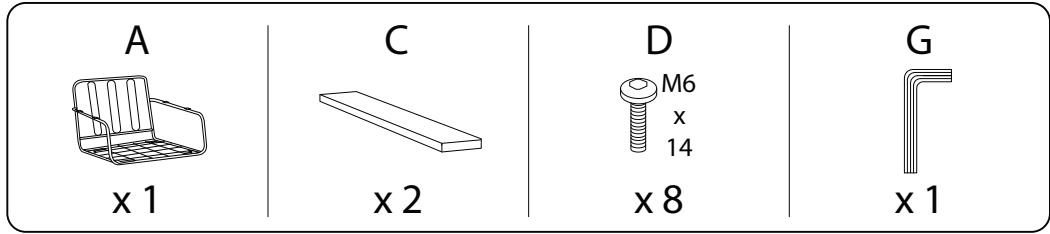



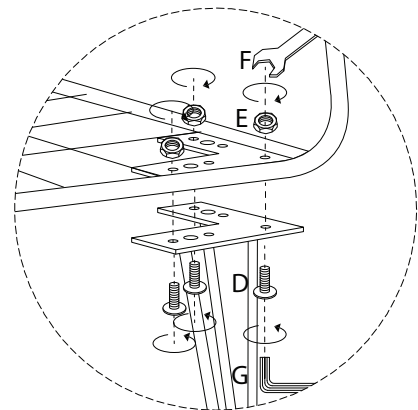
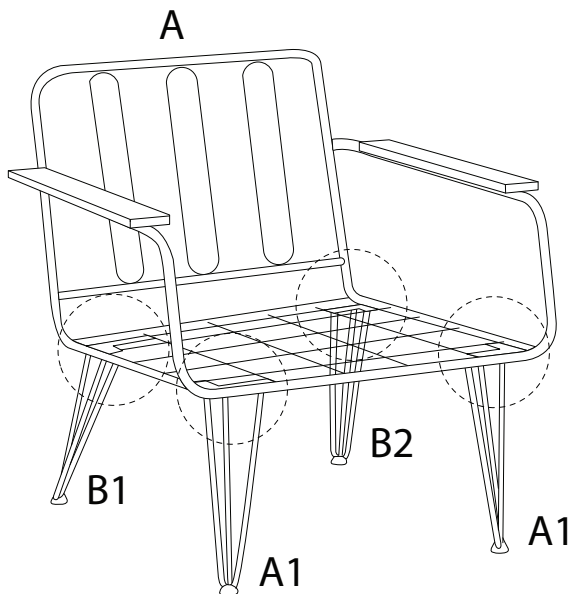
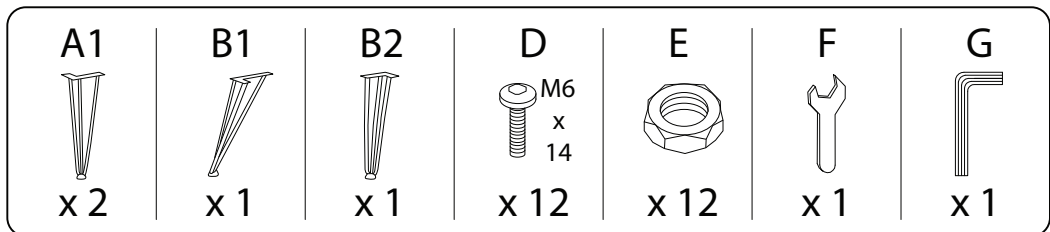

2

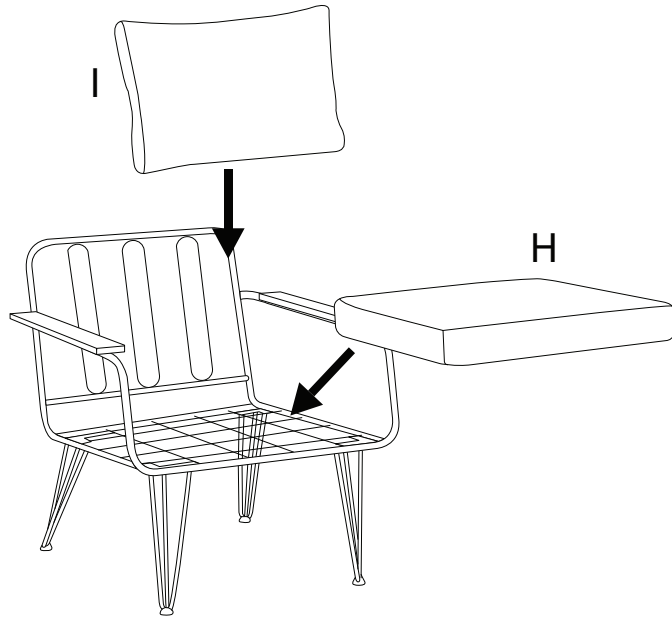
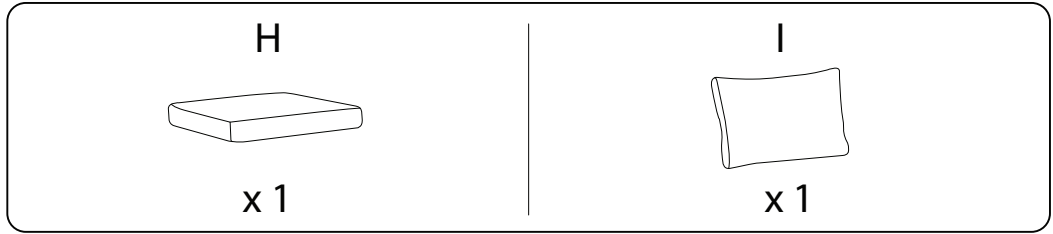

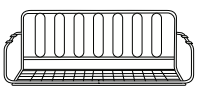

3

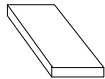

B

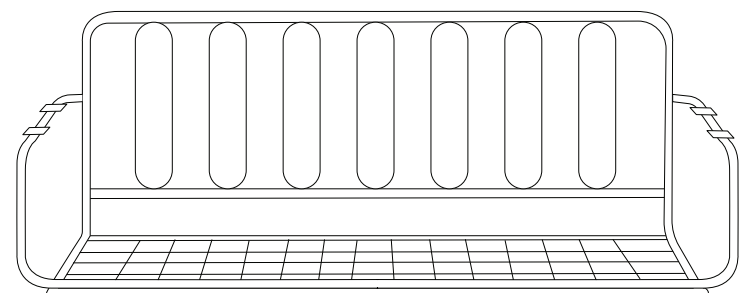
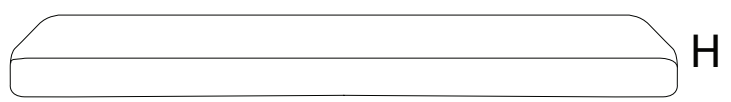
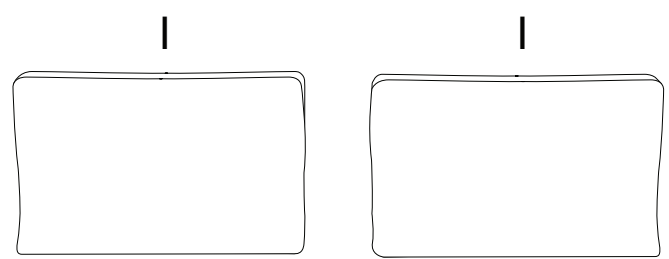
<p>A</p>  <p>x 1</p>	<p>A1</p>  <p>x 2</p>	<p>B1</p>  <p>x 1</p>	<p>B2</p>  <p>x 1</p>	<p>C</p>  <p>x 2</p>
---	--	--	--	---

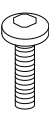
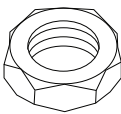
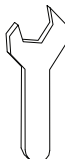
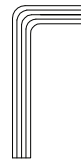

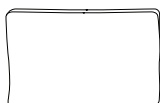
<p>D</p>  <p>M6 x 14</p> <p>x 20</p>	<p>E</p>  <p>x 12</p>	<p>F</p>  <p>x 1</p>	<p>G</p>  <p>x 1</p>	<p>H</p>  <p>x 1</p>	<p>I</p>  <p>x 1</p>
---	--	---	---	---	---

1

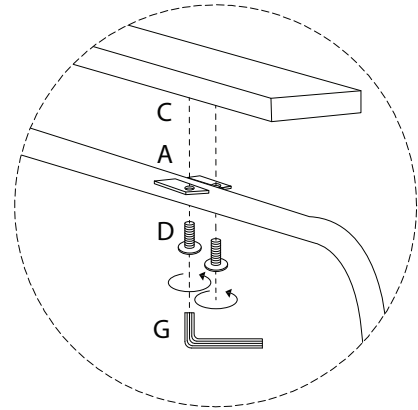
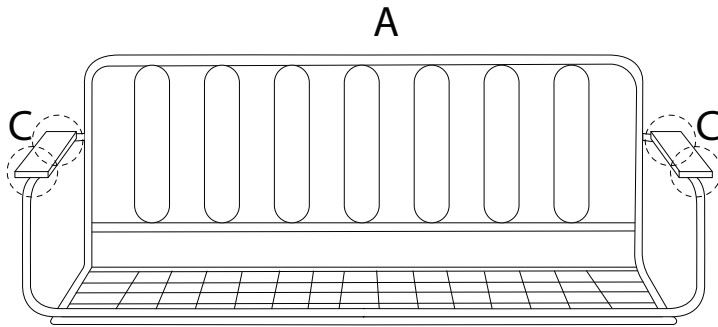
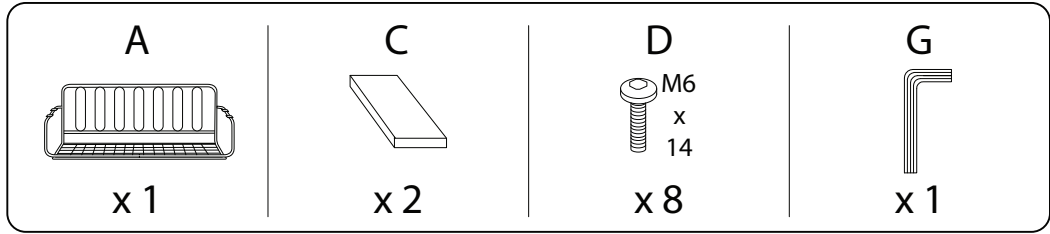

2

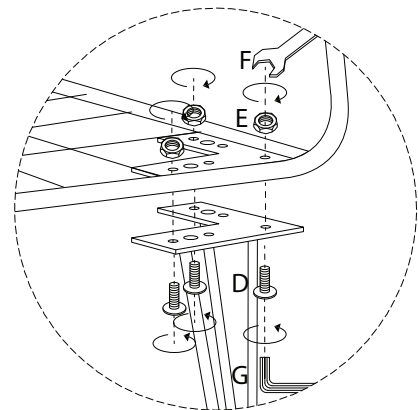
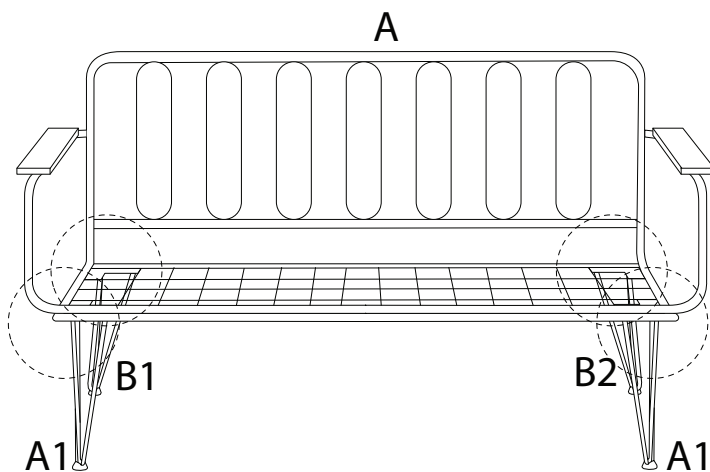
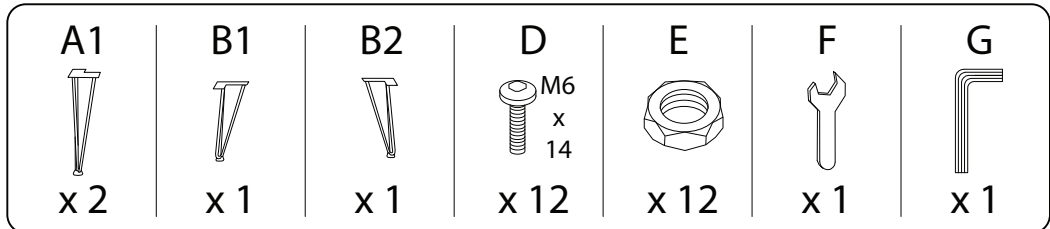

3

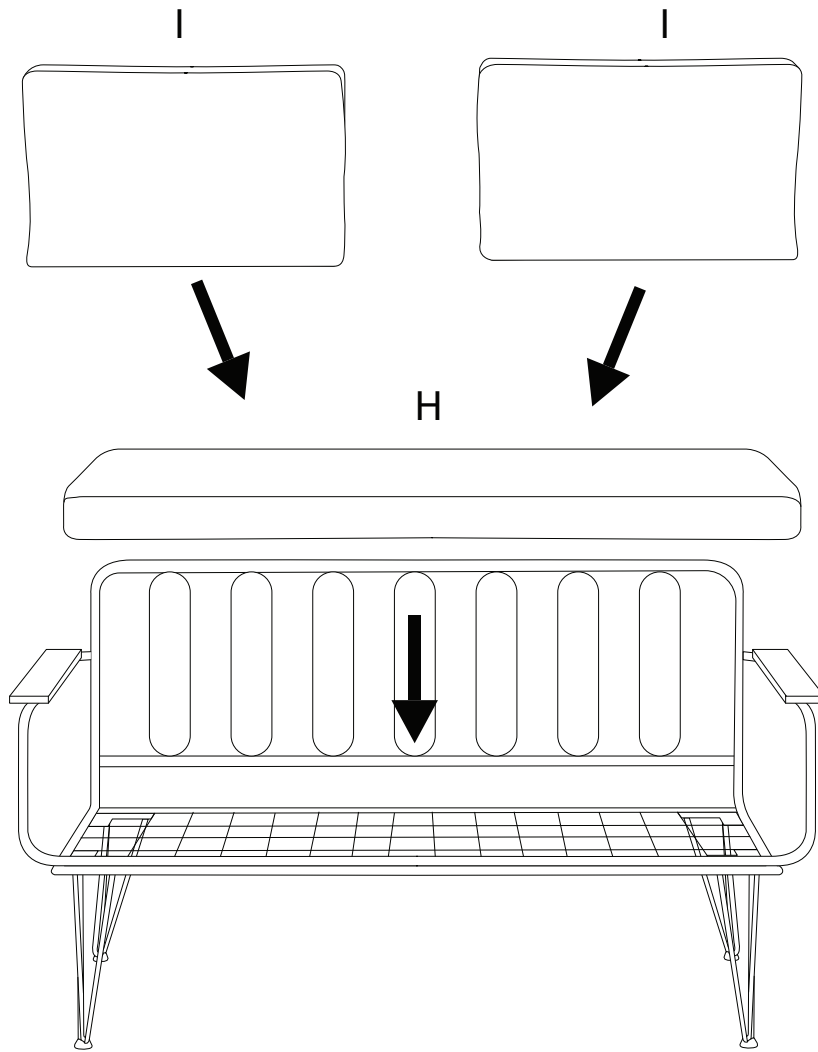
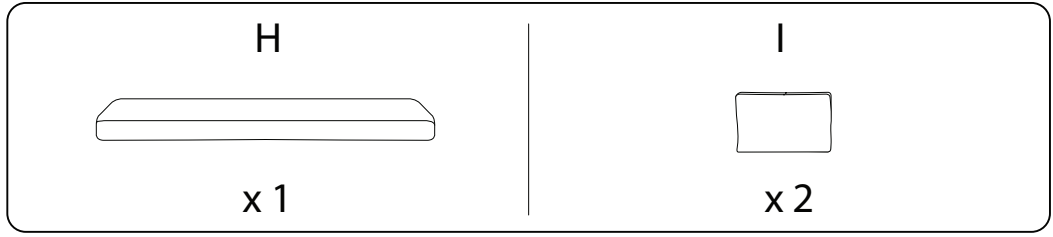

C

A

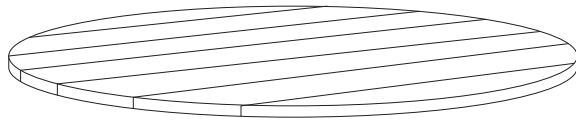

B

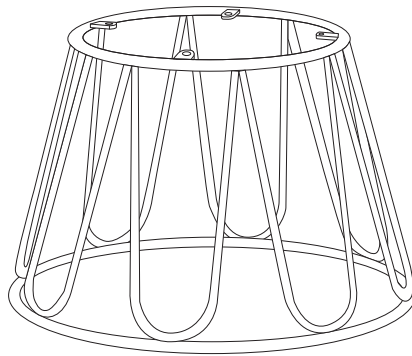

A

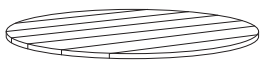

x 1

B

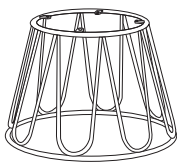

x 1

C



M6
x
14

x 4

D



x 1

1

