

BSB110



Thank you for choosing this furniture.

BEFORE YOU START ASSEMBLY please store the carton at room temperature for 48 hours or more so the contents can acclimatise.

PLEASE RETAIN ALL PACKING UNTIL YOU HAVE COMPLETED ASSEMBLY.

Information about your furniture.

Our pine furniture ranges have been carefully crafted from solid wood and MDF. Each piece of wood has unique characteristics such as knots, variances in shading and graining. These are part of the natural character of the furniture itself.

Caring for your furniture.

Extreme temperature can cause slight movements in the wood itself so please avoid placing your furniture close to radiators or other direct sources of heat. Humidity should also be avoided.

Please avoid exposing your furniture to continued bright sunlight as it can affect the colour.

Any fluid spills should be removed as quickly as possible.

Always lift your furniture when moving as dragging may cause damage to your furniture or flooring.

After care.

Wipe the surfaces with a dry cloth and an occasional use of a normal household furniture polish. We also recommend you use household spray polish occasionally on the drawer grooves and runners as this will aid use. Please do not use detergents or chemicals on your furniture.

PARTS LIST

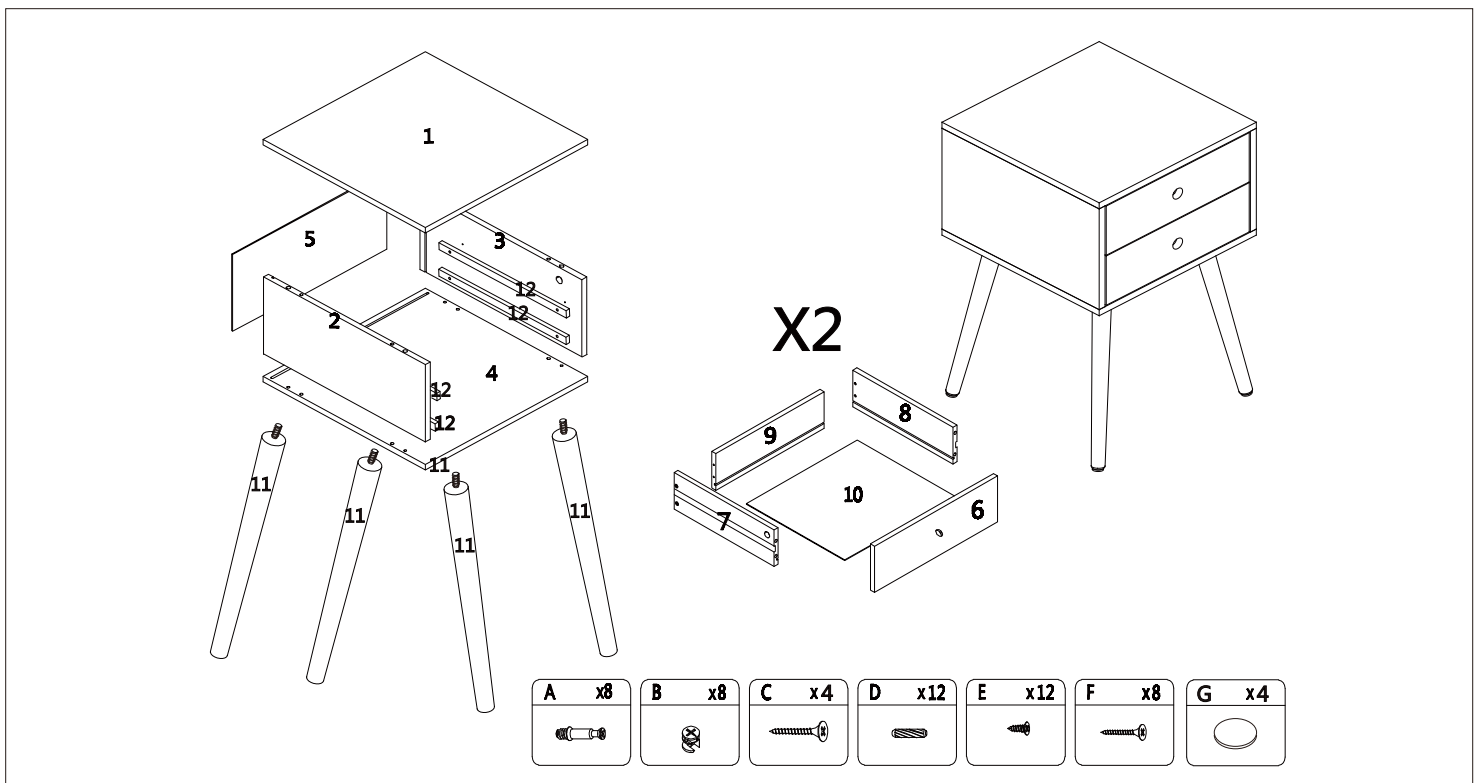

BEFORE YOU START ASSEMBLY

Please check that you have all the correct parts and fittings as detailed in the Parts List above.

In the unlikely event that you require to order spare parts please refer to your delivery note for details of how to order on our Parts Website.

BATCH NUMBER

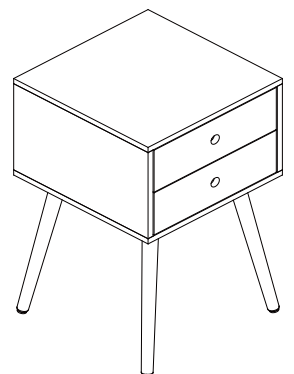

PLEASE RETAIN THIS INSTRUCTION LEAFLET FOR FUTURE REFERENCE.

Step 1

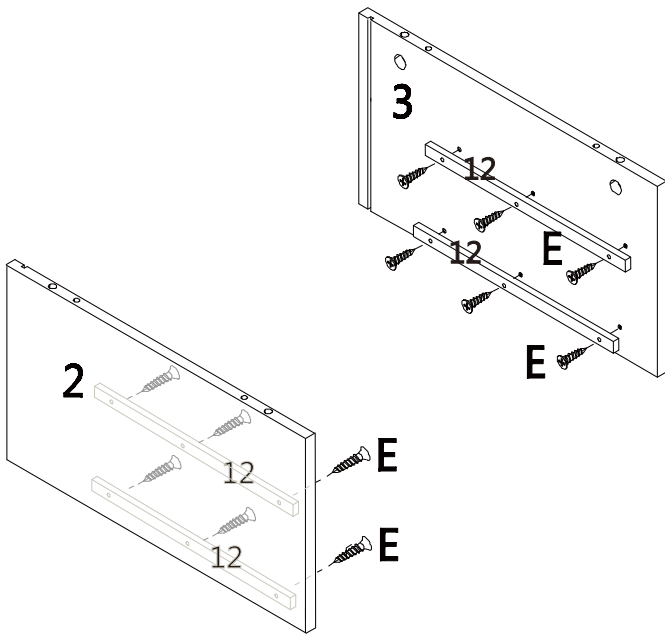

Step 2

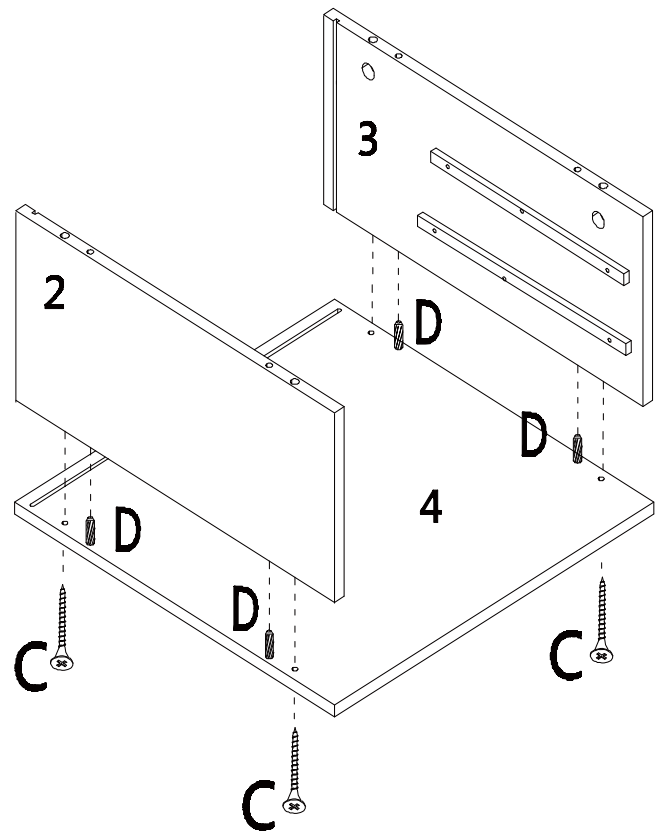

Step 3

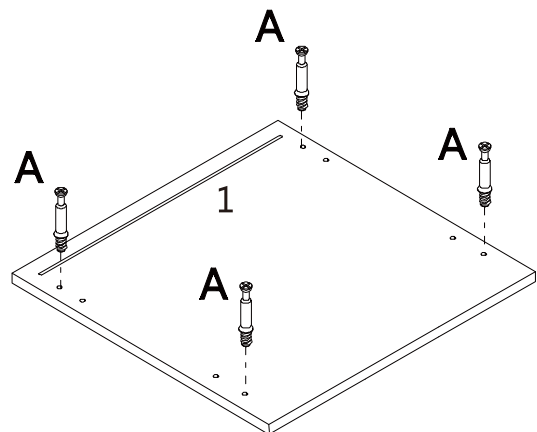
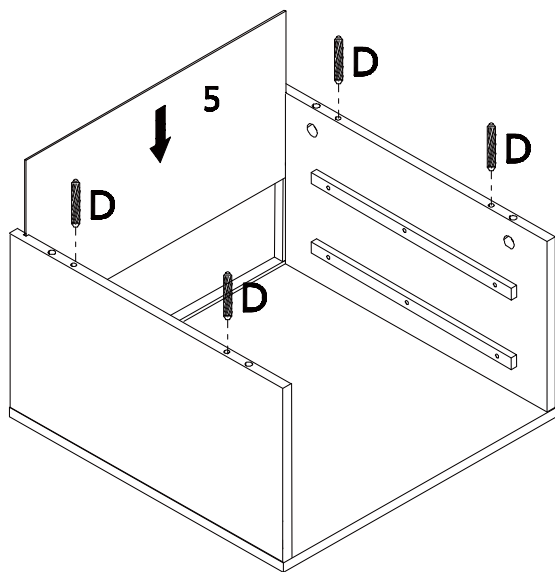

Step 4

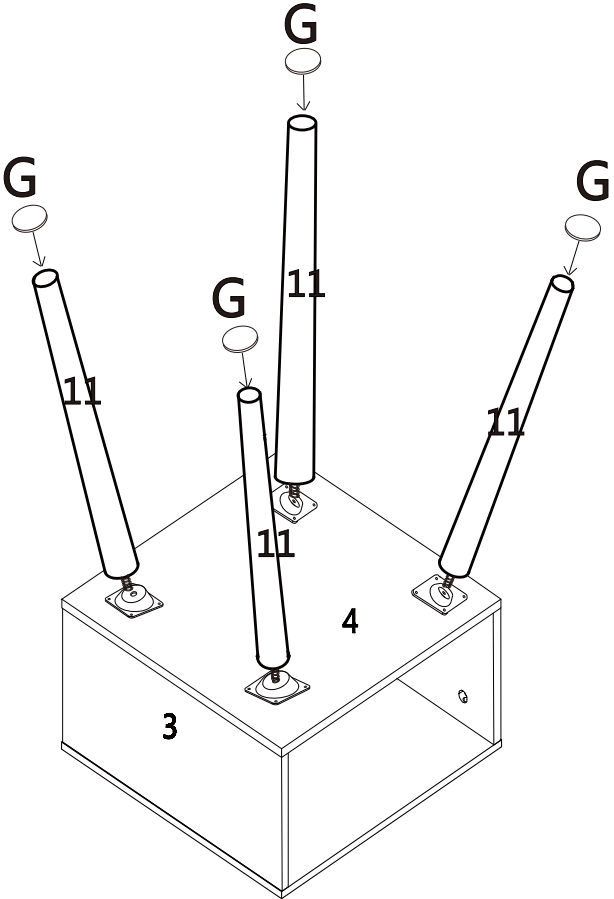
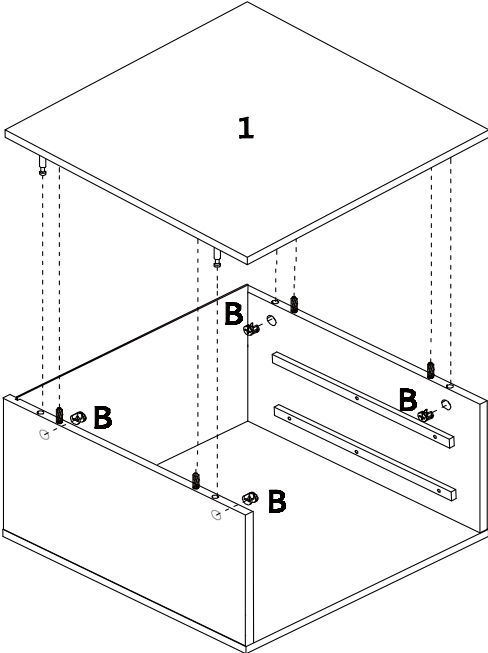

Step 5

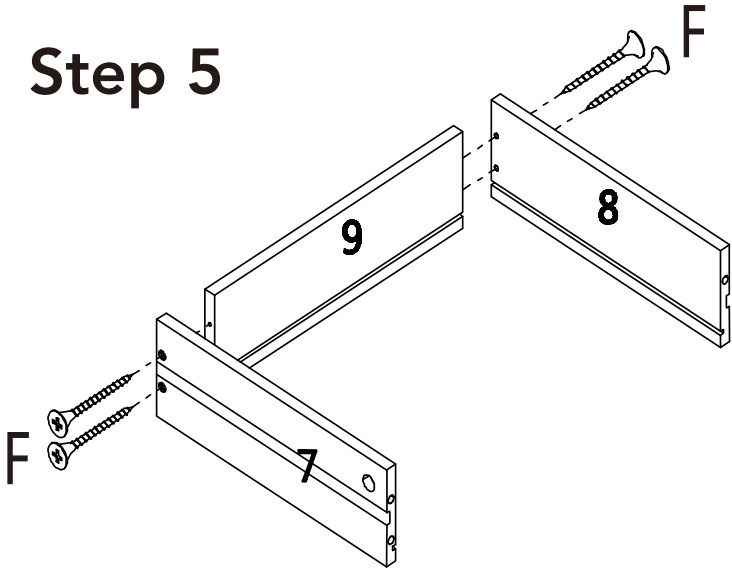

x2

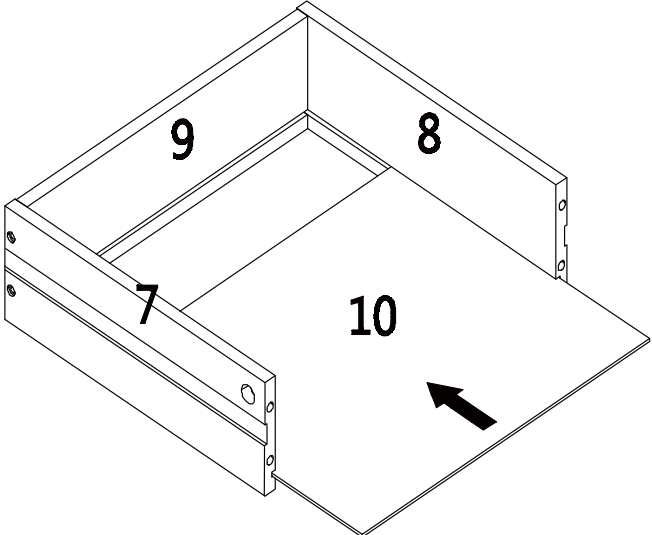

Step 6

x2

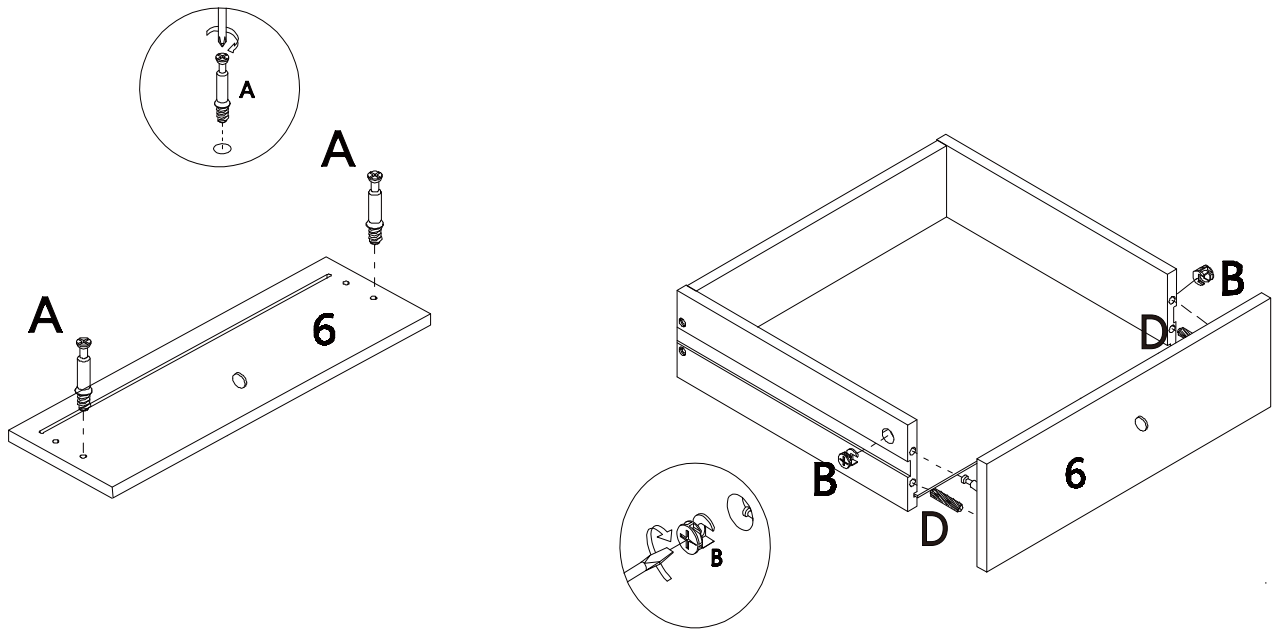

Step 7

