

ASSEMBLY INSTRUCTION

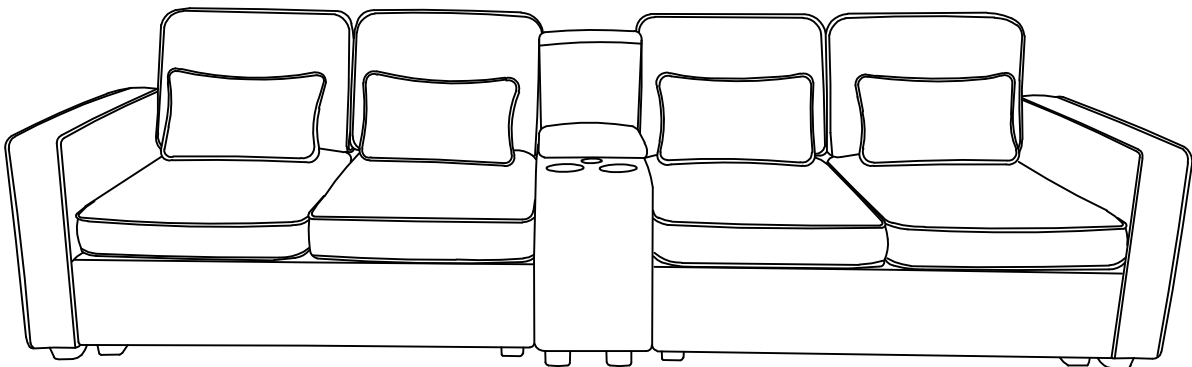





Friendly Reminder:

- 1.This sofa is packed in 3 boxes. Please assemble it After all boxes are received.
- 2.As the cushions are all vacuum compressed,there will be some wrinkles. Please give your cushions up to 72 hours to reach its original size and the wrinkles will basically disappear.
- 3.Please do not open the compressed packags until your sofa frame is completely assembled.







ASSEMBLY INSTRUCTION

HARDWARE









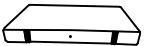

NO	DESCRIPTION	SKETCH	QTY
1	Washer		30
2	Screws 6X35		2
3	Screws 8X40		8
4	Screws 8X60		20
5	Wrench		1
6	Plastic gasket		16

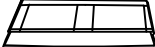
PARTS LIST

NO	DESCRIPTION	SKETCH	QTY
B	Armrest (left)		1
C	Armrest (right)		1
L	Console		1
M	Back frame of console		1
K	Leg(small)		4

ASSEMBLY INSTRUCTION

PARTS LIST

NO	DESCRIPTION	SKETCH	QTY
A	Seat frame		1
D	Front baffle		1
E	Back frame		2
F	Back cover		1
G	Seat cushion		2
H	Back cushion(big)		2
I	Back cushion(small)		2
J	Leg(big)		4
K	Leg(small)		2
N	Data cable		1
O	Plug		1

All parts and hardwares.

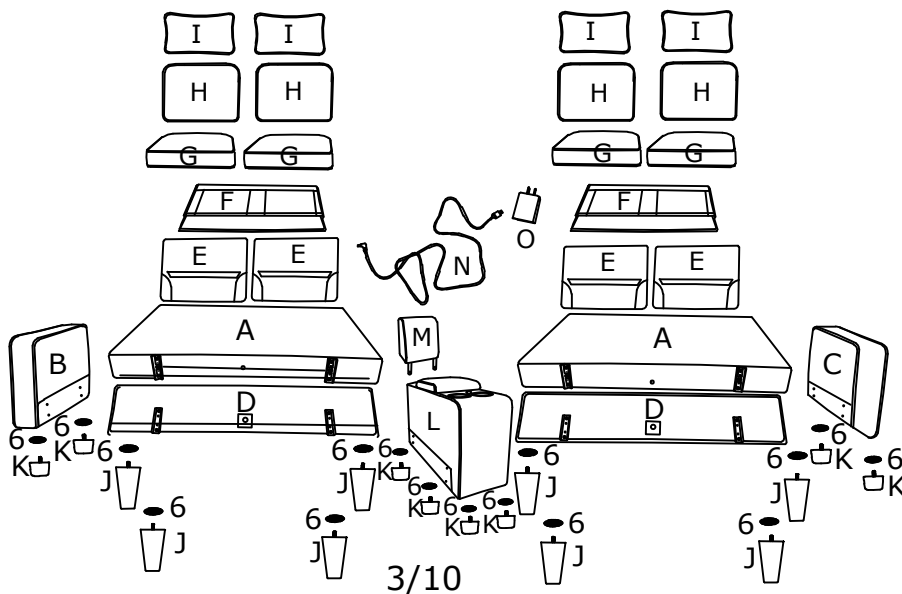

DIAGRAM 1 (Take all parts)

Take the Front baffle(Parts D)Back frame(Parts E)Back cover(Parts F)Seat cushion(Parts G) Back cushion(big)(Parts H)Back cushion(small)(Parts I)Leg(big)(Parts J)Leg(small)(Parts K) out of the Seat frame(Parts A).

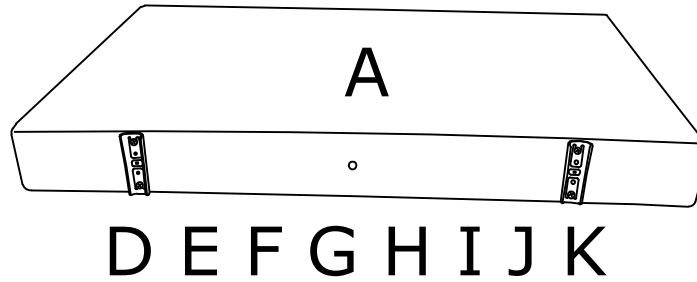

DIAGRAM 2 (Assemble the Legs)

Connect the 16 Plastic gasket (Hardware 6)8 Legs(big)(Parts J) and 8 Legs Leg(small)(Parts K)with the Seat frame (Parts A) with the Armrest (left) (Parts B) with the Armrest (right) (Parts C) with the Console (Parts L).

6		16PCS
J		8PCS
K		8PCS

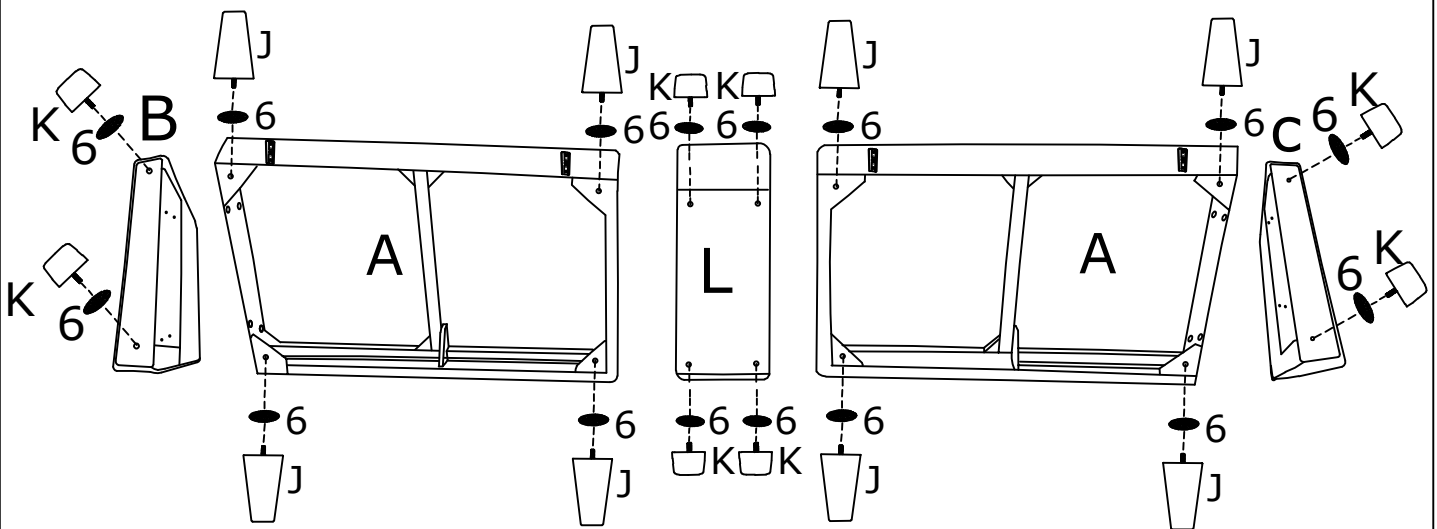

DIAGRAM 3 (Assemble the Seat frame and Front baffle)

Connect the Seat frame (Parts A) and Front baffle (Parts D).

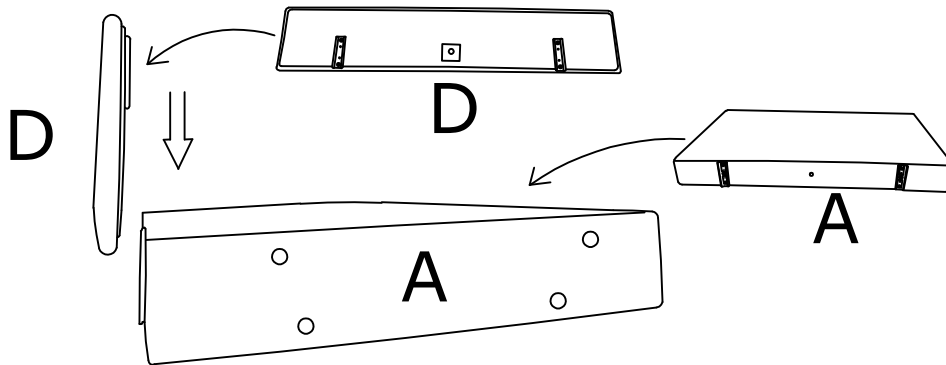



DIAGRAM 4 (Assemble the Seat frame and Front baffle)

Connect the Seat frame(Parts A) to the Front baffle (Parts D) with the Washer (Hardware 1) and the Screws M6X35(Hardware 2) by Wrench (Hardware 5).

1		1PCX2
2	 M6X35	1PCX2

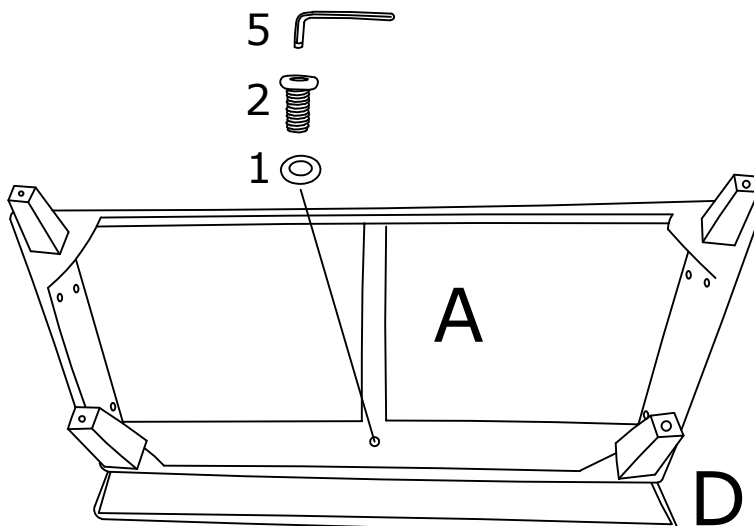



DIAGRAM 5 (Assemble the Armrest to the Seat frame)
 Connect the Armrest (left) (Parts B) to the Seat frame (Parts A) with the Washer (Hardware 1) and the Screws M8X60(Hardware 4) by Wrench(Hardware 5).

1		4PCS
4	 M8X60	4PCS

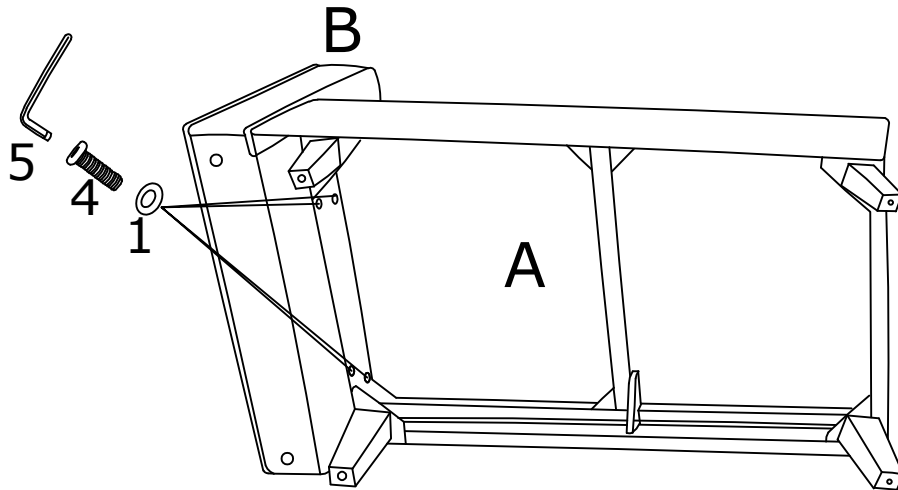



DIAGRAM 6 (Assemble the Armrest to the Seat frame)
 Connect the Armrest (right) (Parts C) to the Seat frame(Parts A) with the Washer (Hardware 1) and the Screws M8X60(Hardware 4) by Wrench(Hardware 5).

1		4PCS
4	 M8X60	4PCS

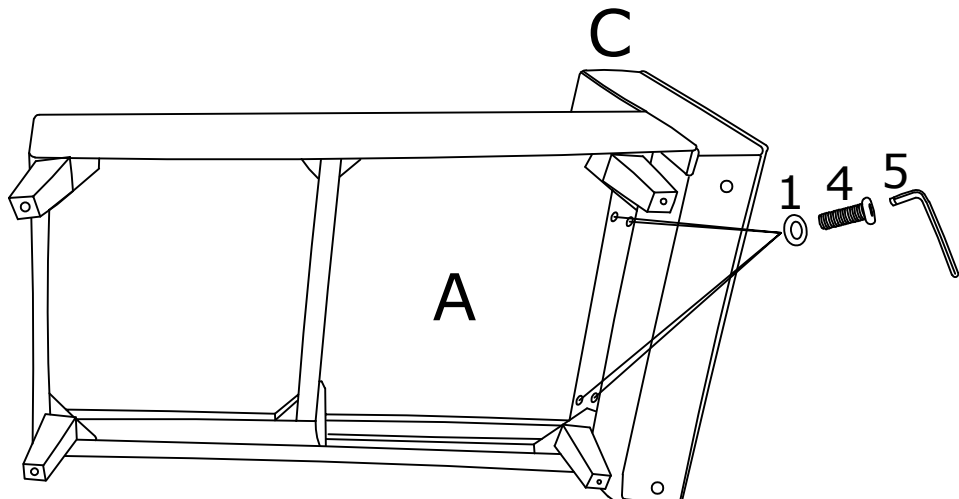



DIAGRAM 7 (Assemble the Console)

Connect the Console(Parts L) to the Seat frame(Parts A) with the Washer (Hardware 1) and the Screws M8X60(Hardware 4) by Wrench(Hardware 5).

1		4PCS
4	 M8X60	4PCS

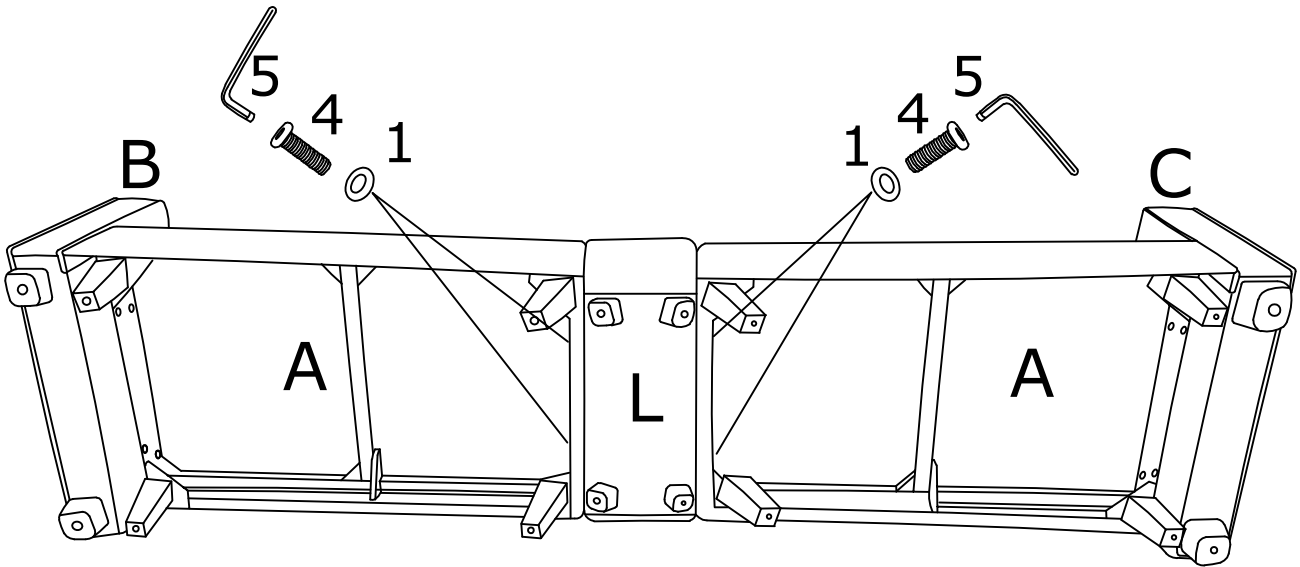
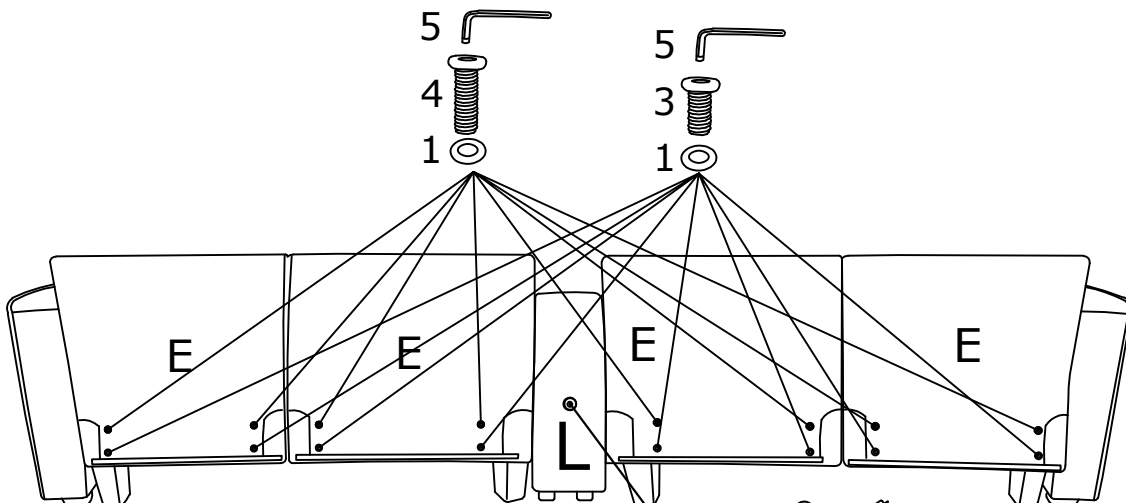

DIAGRAM 8 (Assemble the Back frame)

Connect the Back frame (Parts E)with the 8 Screws M8X40(Hardware 3) and tighten the 8 Screws M8X60(Hardware 4)with the Washer (Hardware 1) by wrench (Hardware 5).

1		16PCS
3	 M8X40	8PCS
4	 M8X60	8PCS



Connect the Data cable (Parts N)and the Plug(Parts O) to the Console (Parts L)

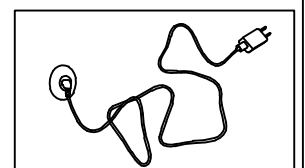
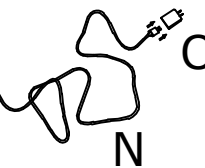
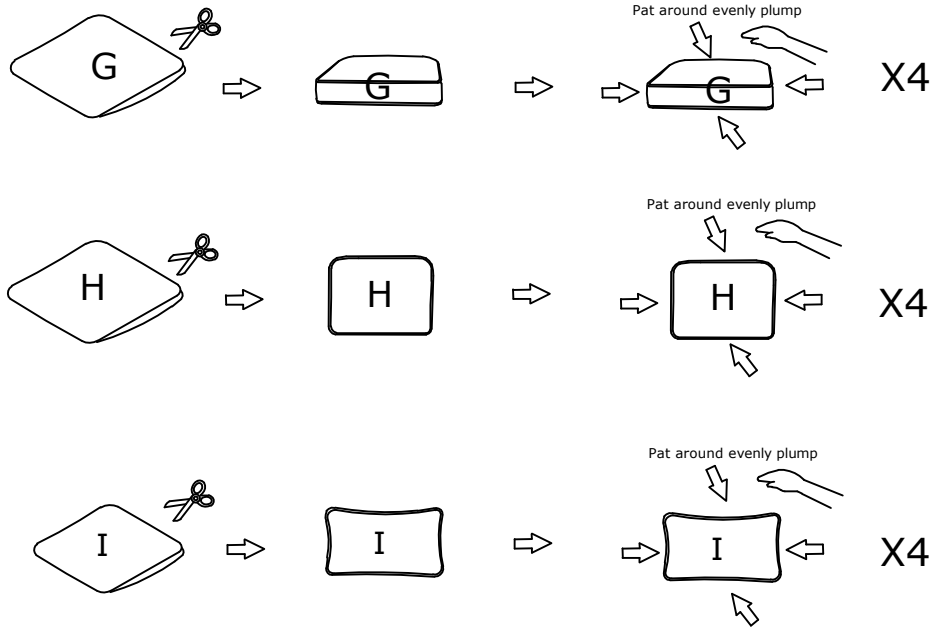

DIAGRAM 9 (Removal of compression bags)

Remove the Seat cushion(Parts G)the Back cushion(big)(Parts H) the Back cushion(small)(Parts I).



TIPS:

1. Please do not open the compressed packages until your sofa frame is completely assembled.
2. Compressed back cushions and pillows need to be fully fulfilled within 72 hours for your perfect use.
3. Please keep children away from plastic bags or any small pieces of stuff.

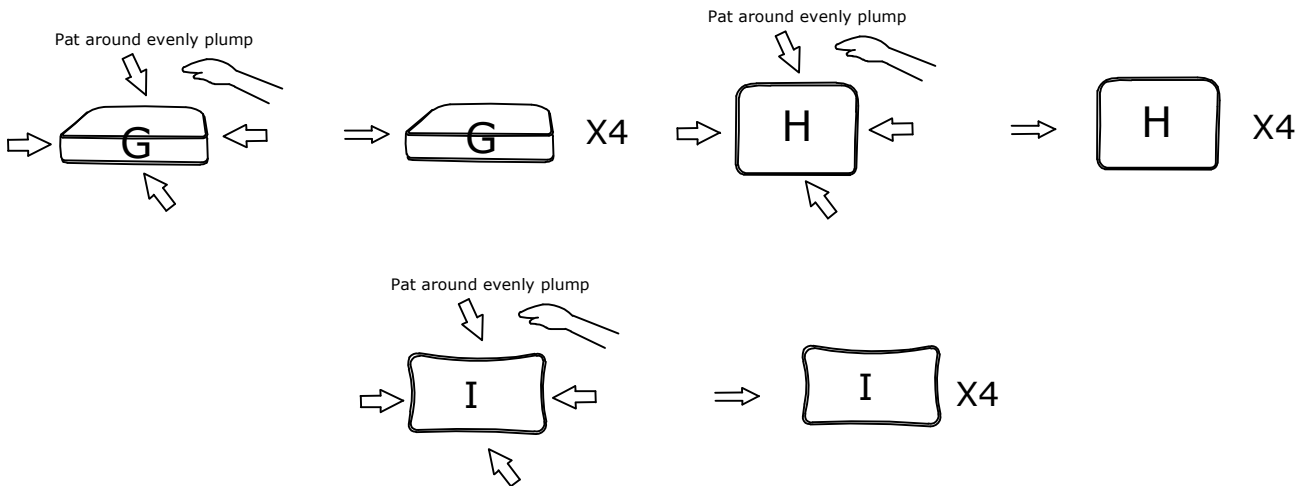

DIAGRAM 10 (Place the Back cover on the sofa)

Put the Back cover (Parts F).

Align the holes in the placement ,put the Back frame of console(Parts M) on the Console(Parts L).

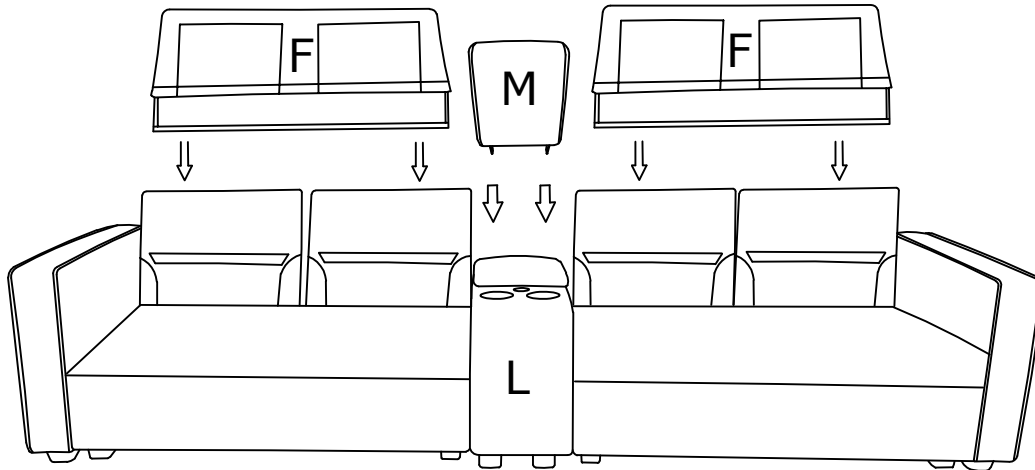

DIAGRAM 11 (Place the Seat cushion on the sofa)

Put the Seat cushion (Parts G).

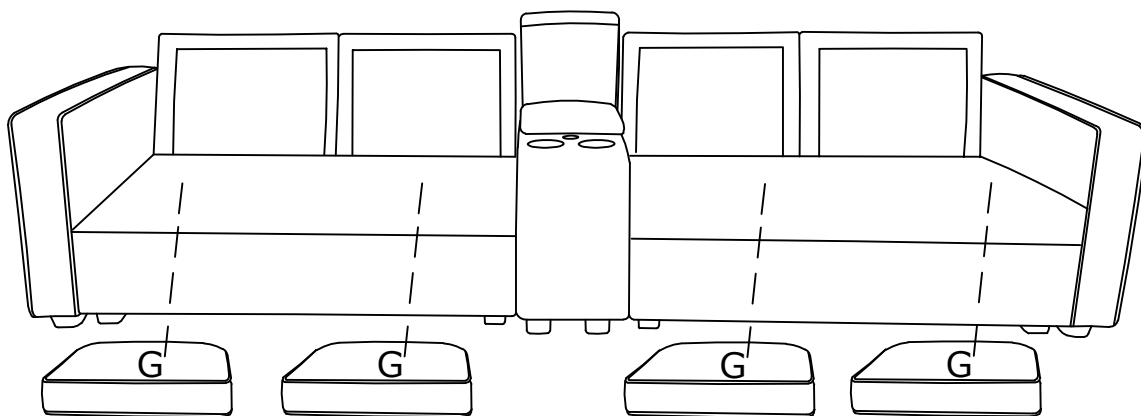
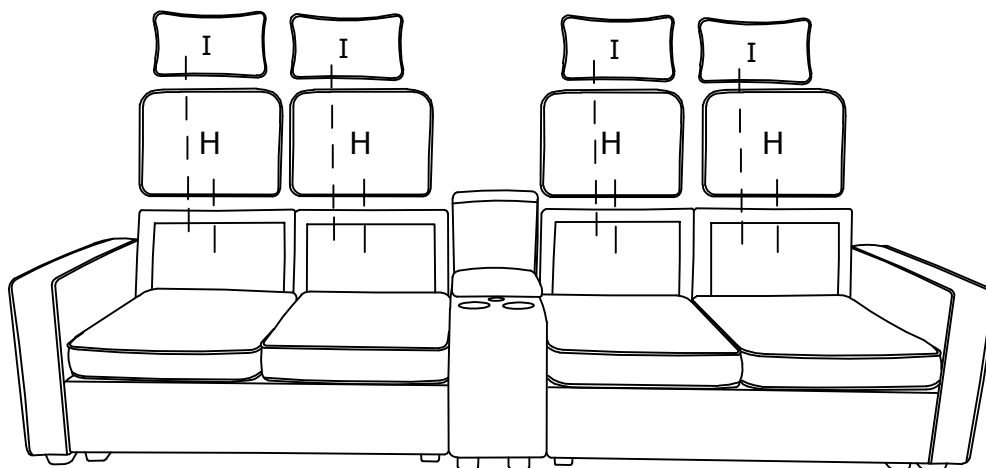

DIAGRAM 12 (Place the Back cushion(big) and Back cushion(small)on the sofa)

Put the Back cushion(big) (Parts H)and Back cushion(small) (Parts I) on the sofa.

Recheck all the bolts before you sit on the sofa.



TIPS:

1. Please do not open the compress packaging until your sofa frame is completely assembled.
2. Compress back cushions and pillows need to be fully fulfilled within 72 hours for your perfect use.
3. Please keep children away from plastic bags or any small pieces of stuff.

