

Assembly Instructions

Caution : You must read this before you proceed.

Please look in the Right Leg Panel for hardware packs

BAR STOOL

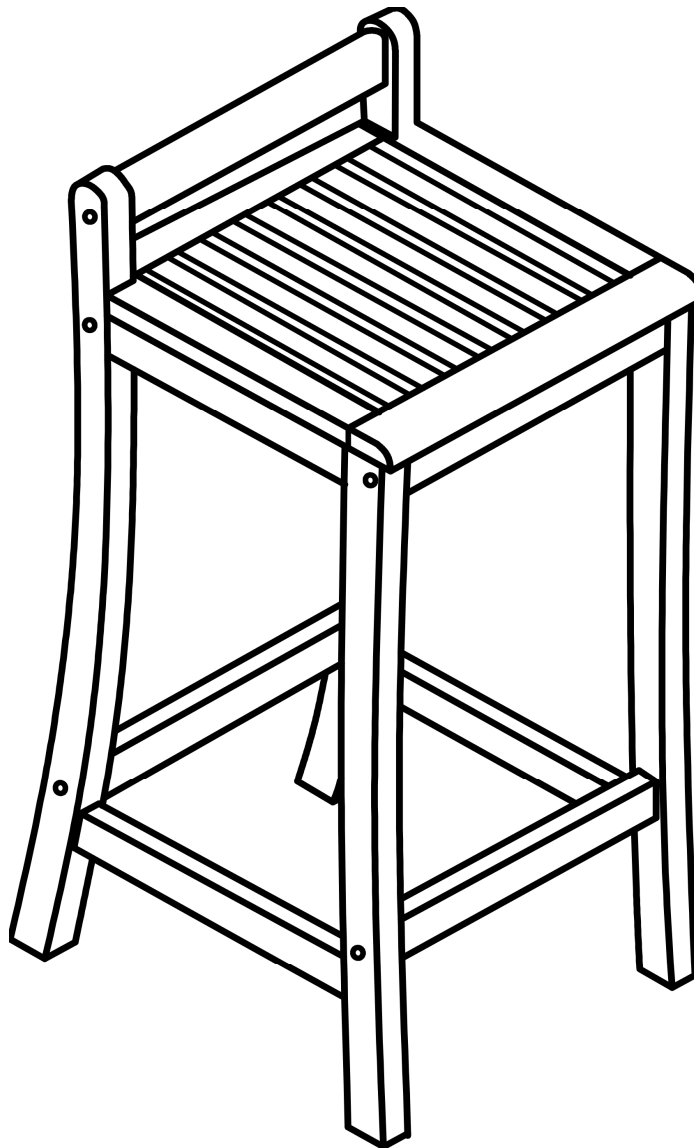

CAUTION : This PRODUCT is NOT a TOY.
Keep your child / children at bay in the process of assembly.

Assembly Preparation

Before Beginning Assembly:

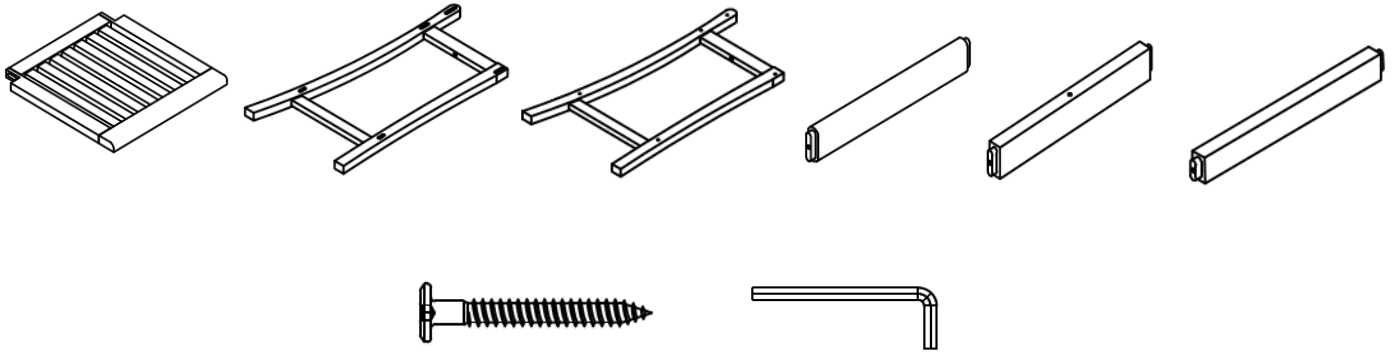

- Read instructions, cover to cover-



- Have 2 adults on hand for assembly-



- Do not assemble on flooring or carpet-



- Assemble on a clean non-marring surface (packing foam)-



- Save all packaging until finished-

Parts List

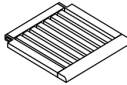
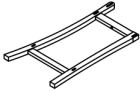
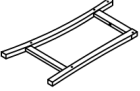
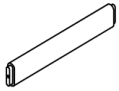
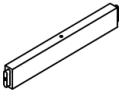
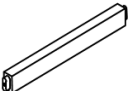
NO.	Picture	Description	QTY
A		Seat	1
B		Right Leg Panel	1
C		Left Leg Panel	1
D		Backrest Bar	1
E		Seat Support Bar	2
F		Leg Support Rail	2

Hard ware

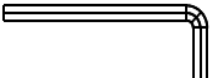
G		Screws (M6x60mm)	15
H		Allen Wrench	1

Assembly Step

Step 1

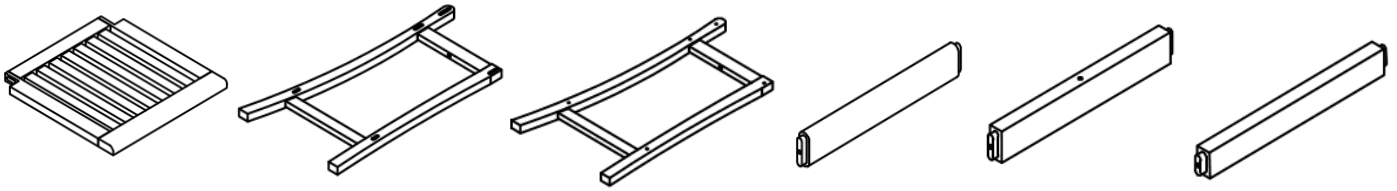

Unpack and place all parts on a clean, non-marring surface.

Step 2

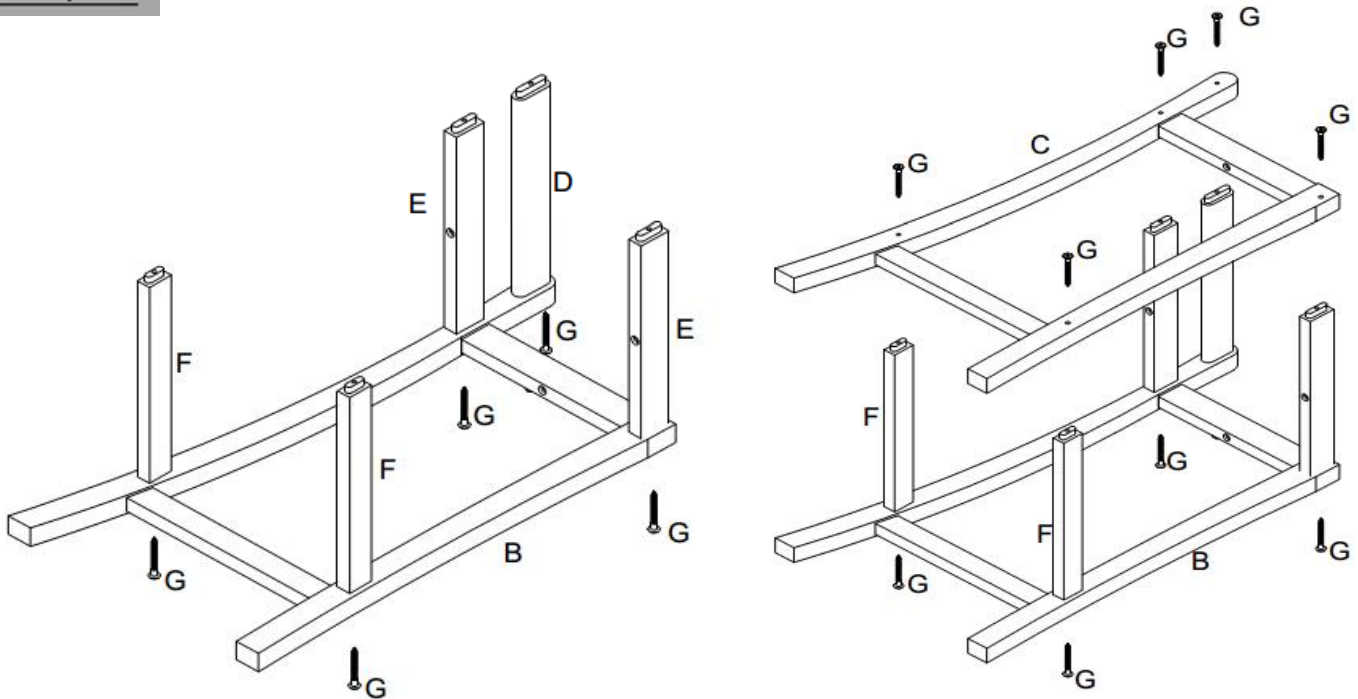

Place the Right Leg Panel(B) face up on its side.
Align and insert Backrest Bar(D), Seat Support Bars(E) and Leg Support Rails(F) with tenons from the bars sitting snugly into Mortises on Right Leg Panel(B).

Insert the Screws(G) through Mounting Positions on the Right Leg Panel(B) with Allen Wrench(H).

Then repeat the same process for the Left Leg Panel(C).

Step 3

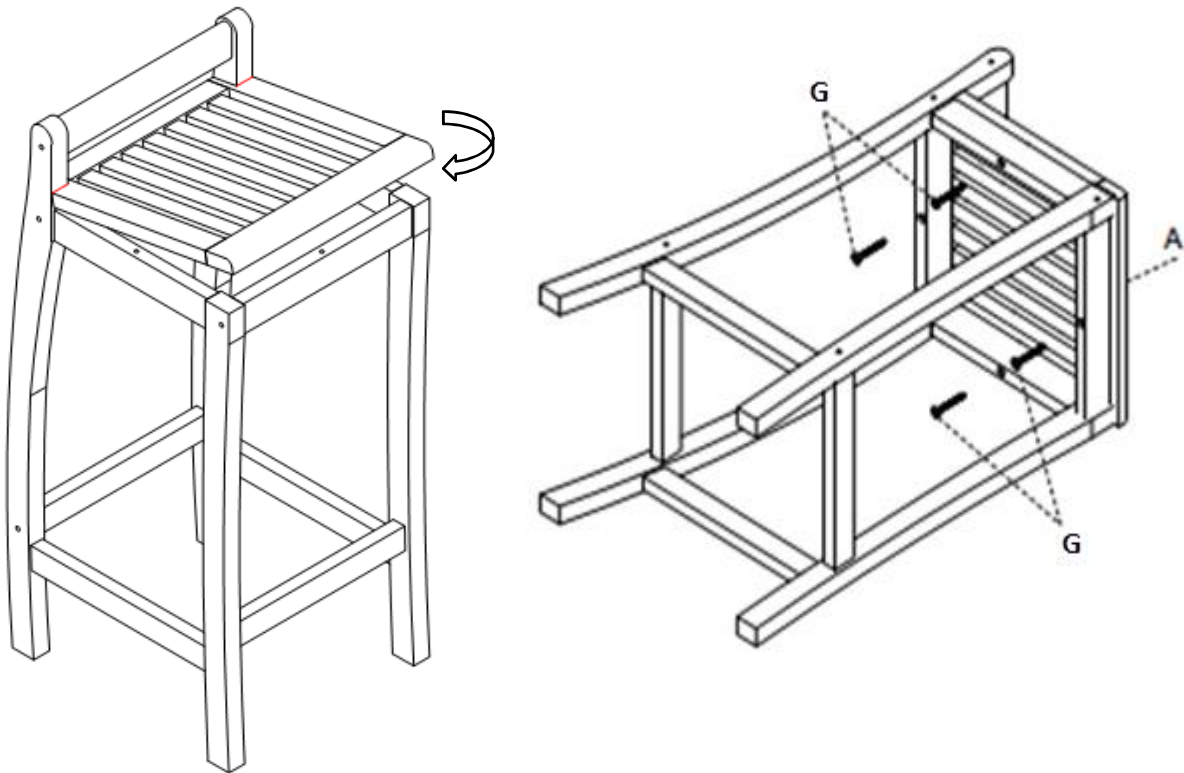

Stand the Stool Frame up and place Seat(A) onto the Stool Frame. To affix the Seat to the Stool Frame, carefully lay down the Bar Stool and align the Mounting Position of the Stool Frame to the Mounting Positions at the Seat(A).

Insert Screws(G) through the Mounting Positions with Allen Wrench(H) and slightly tighten the Screws.

Then stand the Bar Stool up. Check both sides of Seat(A) are flush with the Stool Frame and tighten the Screws(G) sequentially.

If no wobbles found, proceed to tighten all the screws.

CAUTION : When tightening these screws, tighten sequentially.

DO NOT tighten any screw fully and then towards the next one.

This would cause the Stool Frame to warp.

If there is still wobbles, loosen the screws and execute this same drop tests.

WARNING!! IF CHAIR IS NOT STABLE , IT COULD LEAD TO DAMAGING THE PRODUCT.

Step 4

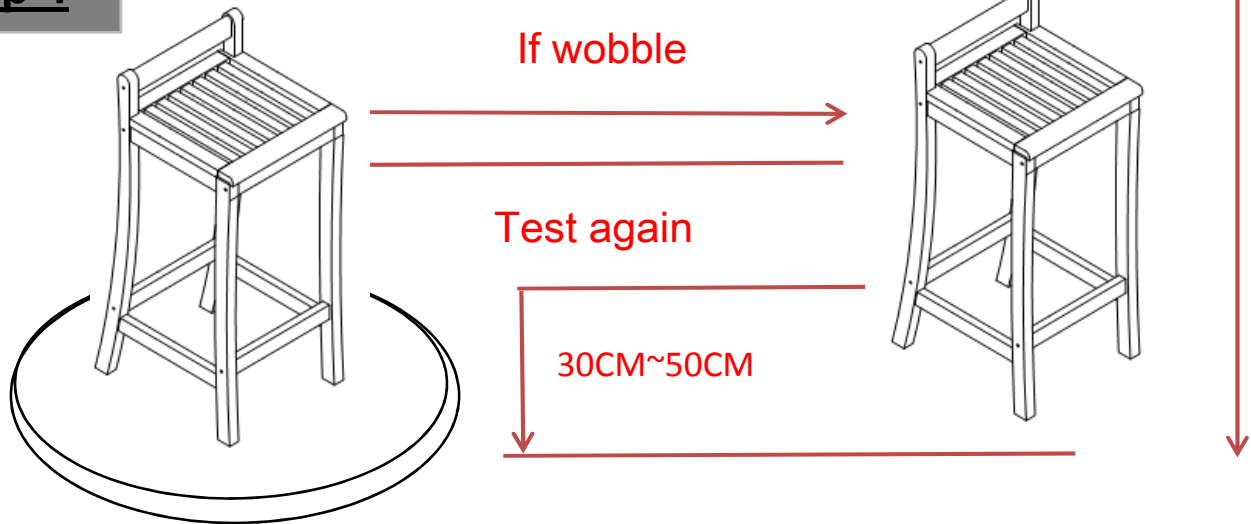

Place the chair on a **LEVEL SURFACE** to see if it wobbles.

If it wobbles, lift the chair to some 30cm to 50cm height from the ground.

Keep your feet and toes well away from the drop zone.

Drop the chair freely and vertically with the four legs, hitting the ground, at the same time.

This Drop Test will help to ensure that all the screws and gaps to all reach full alignment status.

Test again for evenness on a **LEVEL SURFACE**.

If no wobbles found, proceed to tighten all the screws.

CAUTION: When tightening these screws, tighten sequentially.

DO NOT tighten any screw fully and then towards the next one.

This would cause the frame to warp.

If there is still wobbles, loosen the screws and execute this same drop tests.



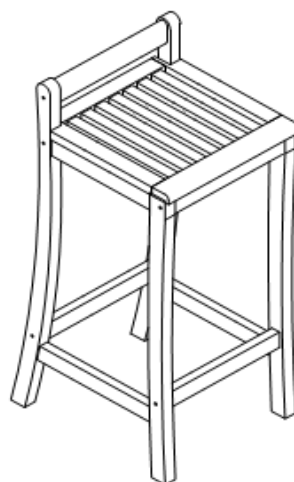















Step 5



Ensure that all Screws are securely tightened.

Your Bar Stool is ready for use.

Care & Maintenance

-   ● Do not put hot items directly on furniture surface
 -   ● Do not clean furniture with harsh cleansers or polish.
 -   ● To obtain the longest lifespan of your outdoor products, minimizing exposure to direct sunlight is recommended.
 -   ● Children should not climb or jump on the furniture.
 -   ● Do not write on furniture without a padded barrier to protect the surface.
 -   ● To obtain the longest lifespan of your outdoor products, avoid extended and lengthy exposure to rain, snow, and direct sunshine. Whenever possible cover the product and /or place under patio or awnings.
 -   ● Not for commercial use. For residential use only .
 -   ● Stains may be removed with mild soap solution and damp cloth.
-
-   ● Dust and pick-up spills using a clean, non-colored, lint-free cloth .