

# Assembly Instruction For / Instruction D'assemblage pour

KING & QUEEN HEADBOARD



TÊTE DE LIT GRAND FORMAT ET TRÈS GRAND FORMAT





Caution: Please read instructions thoroughly before unpacking assembly parts. Sharp, exposed staple tips can cause injury, therefore, for your protection, please remove any exposed staples used in packing.

1. We recommend that you should assemble this product with the assistance of another person; this will make assembly easier, and will help to eliminate damage the product or injury to persons during assembly.
2. Be sure to check all packing materials carefully for small parts that may have come loose inside the carton during shipment.
3. Please do not over tighten screws or bolts.
4. Please put all parts on a non-abrasive floor before assembly, and follow the assembly steps to assemble your newly purchased product correctly and efficiently.

Attention: S'il vous plait lire attentivement les instructions avant de déballer les pièces d'assemblage. Pour votre protection et éviter les blessures, s'il vous plait retirer les agrafes exposés utilisés pour l'emballage.

1. Nous vous recommandons d'assembler ce produit avec l'aide d'une autre personne; cela facilitera le montage, et aidera à éliminer les dommages au produit ou des blessures lors de l'assemblage.
2. Assurez-vous de vérifier soigneusement tous les matériaux d'emballage pour les petites pièces qui peuvent avoir été lâche à l'intérieur du carton pendant le transport.
3. Nous vous demandons de ne pas trop serrer les vis ou des boulons.
4. Il est recommandé de mettre toutes les pièces d'assemblage sur un sol non abrasif avant l'assemblage et de suivre les étapes d'assemblage une par une pour assembler votre nouveau produit correctement et efficacement.

PART LIST / LISTE DES PIÈCES				
NO.	PART DESC LISTE DES PIÈCES	SKETCH	Q'ty	CODE
1	HEADBOARD		1PC	
2	HEADBOARD LEG		2PCS	

HARDWARE LIST/LISTE DE MATÉRIEL (PACK WITH HEADBOARD)			
NO.	HARDWARE DESC / LISTE DE QUINCAILLERIE	CODE	Q'ty
A	 BOLT Ø5/16"*2-1/4"		8pcs
B	 SPRING WASHER Ø5/16"		8pcs
C	 FLAT WASHER Ø5/16"*3/4"		8pcs
D	 ALLEN KEY Ø1/8"		1pc



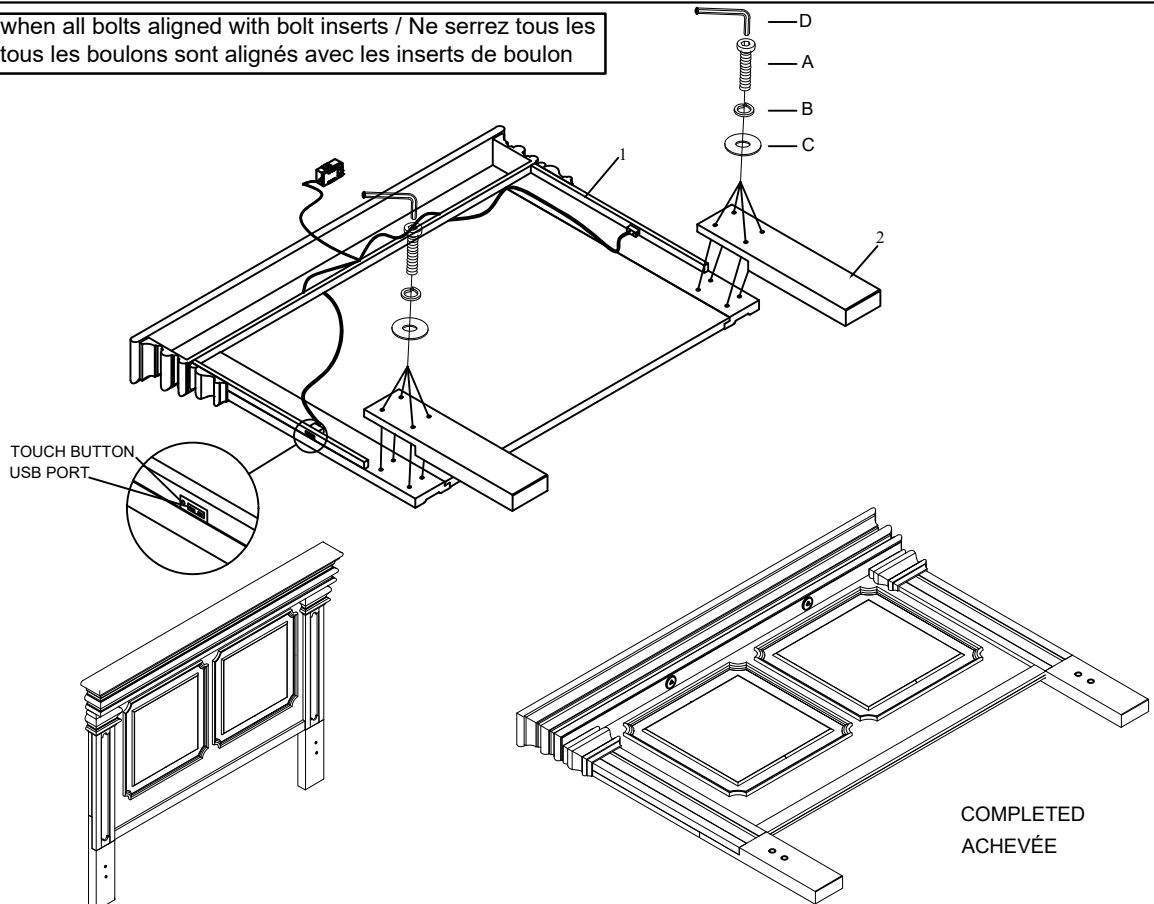



⚠ Only tighten all bolts when all bolts aligned with bolt inserts / Ne serrez tous les boulons que lorsque tous les boulons sont alignés avec les inserts de boulon







COMPLETED  
ACHEVÉE

# Assembly Instruction For / Instruction D'assemblage pour

## QUEEN BED & QUEEN STORAGE BED / GRAND LIT & LIT DE RANGEMENT GRAND

PART LIST / LISTE DES PIÈCES				
NO.	PART DESC LISTE DES PIÈCES	SKETCH	Q'ty	CODE
1	HEADBOARD		1PC	
2	SIDE RAILS		2PCS	
3	FOOTBOARD		1PC	
4	STORAGE FOOTBOARD		1PC	
5	SLATS		4PCS	
6	SUPPORT LEGS		4PCS	

HARDWARE LIST/ LISTE DE MATÉRIEL (PACK WITH SIDERAILS)			
NO.	HARDWARE DESC / LISTE DE QUINCAILLERIE	CODE	Q'ty
A	 BOLT Ø5/16"*1"		8pcs
B	 SPRING WASHER Ø5/16"		8pcs
C	 FLAT WASHER Ø5/16"*3/4"		8pcs
D	 ALLEN KEY Ø1/8"		1pc

HARDWARE LIST/ LISTE DE MATÉRIEL (PACK WITH FOOTBOARD/STORAGE FOOTBOARD)			
NO.	HARDWARE DESC / LISTE DE QUINCAILLERIE	CODE	Q'ty
E	 Screw Ø8*1-1/4"L		8pcs

⚠ Only tighten all bolts when all bolts aligned with bolt inserts / Ne serrez tous les boulons que lorsque tous les boulons sont alignés avec les inserts de boulon

