

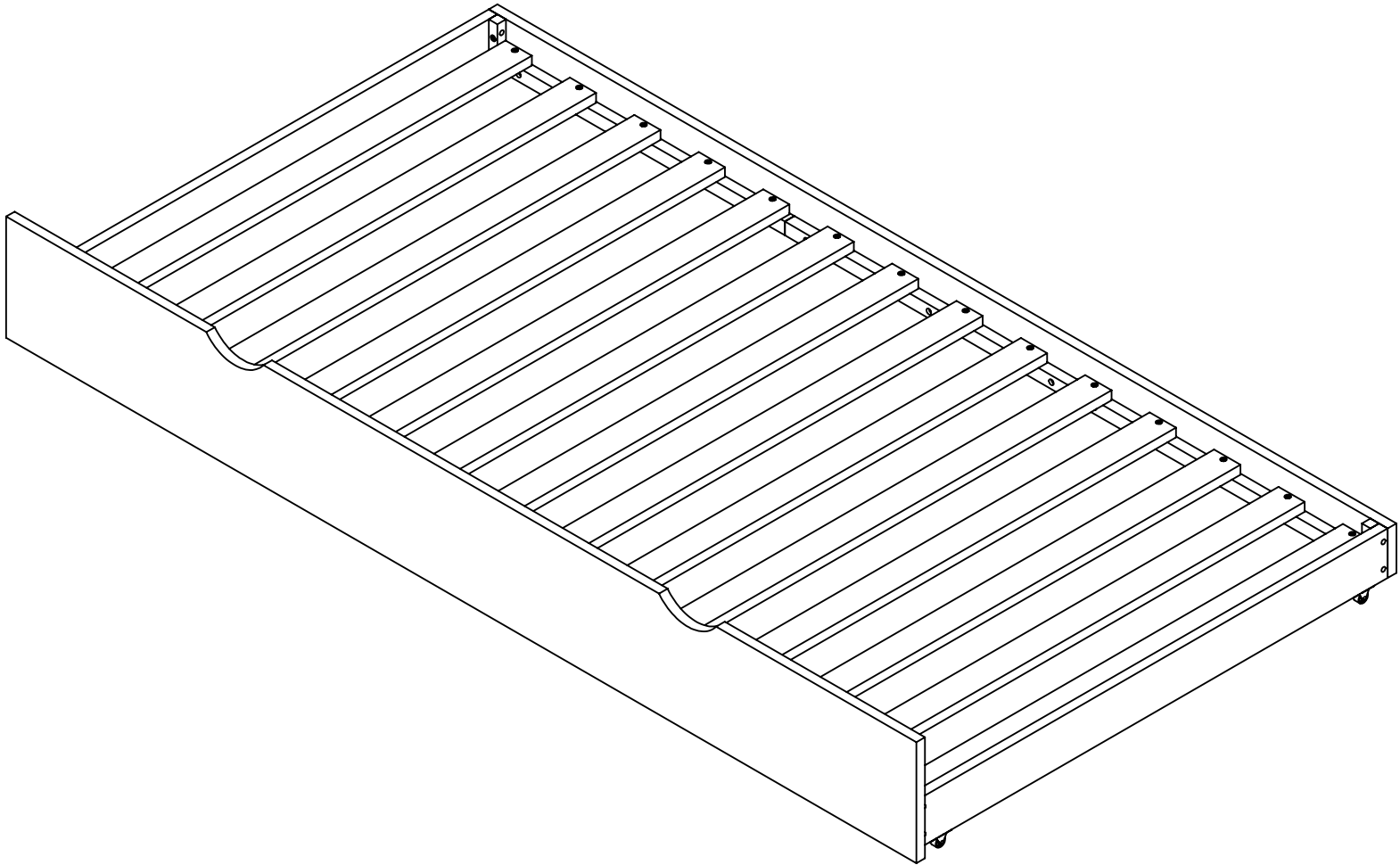

Pull Out Out Bed



PARTS LIST & ILLUSTRATION

Thank you for purchasing this product. Be sure to check all packing material carefully for small parts which may have come loose inside the carton during shipment. Separate, identify, and count all parts and metal hardware. Compare with parts list to be sure all parts are present. If any part(s) are missing or damaged, please contact your local furniture dealer. For efficient and speedy service, please indicate the model number and code letter of part(s) needed.

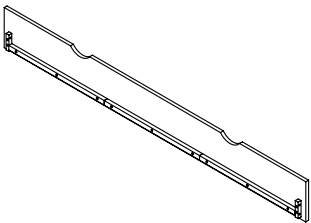
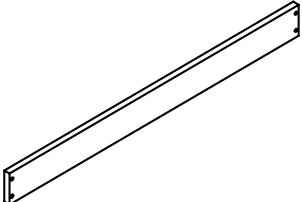
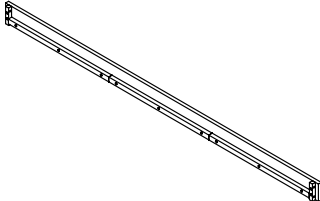
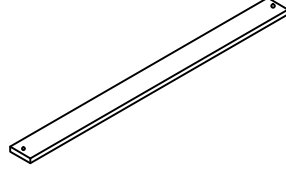
***Note: Do not fully Tighten screws until Fully Assembled ***

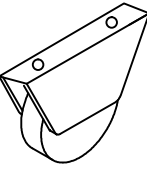
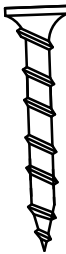
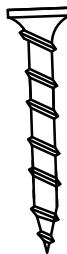
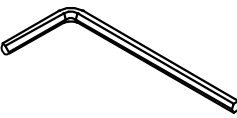
				
<p>Front panel 1 pcs</p>	<p>Side panel 2 pcs</p>	<p>Back panel 1 pcs</p>	<p>Slats 14 pcs</p>	
 <p>1/4*35 mm</p>		 <p>M4*30 mm</p>	 <p>M3.5*20 mm</p>	
<p>Hex-Headbolts 8 pcs</p>	<p>Wheels 4 pcs</p>	<p>Wood screws 28 pcs</p>	<p>Wood screws 8 pcs</p>	<p>Allen key 1 pcs</p>

Attention: Some parts listed on the instruction sheet may not be in parts bag as they may already be assembled.
Carefully check parts and packing material prior to ordering replacement.

STEP 1

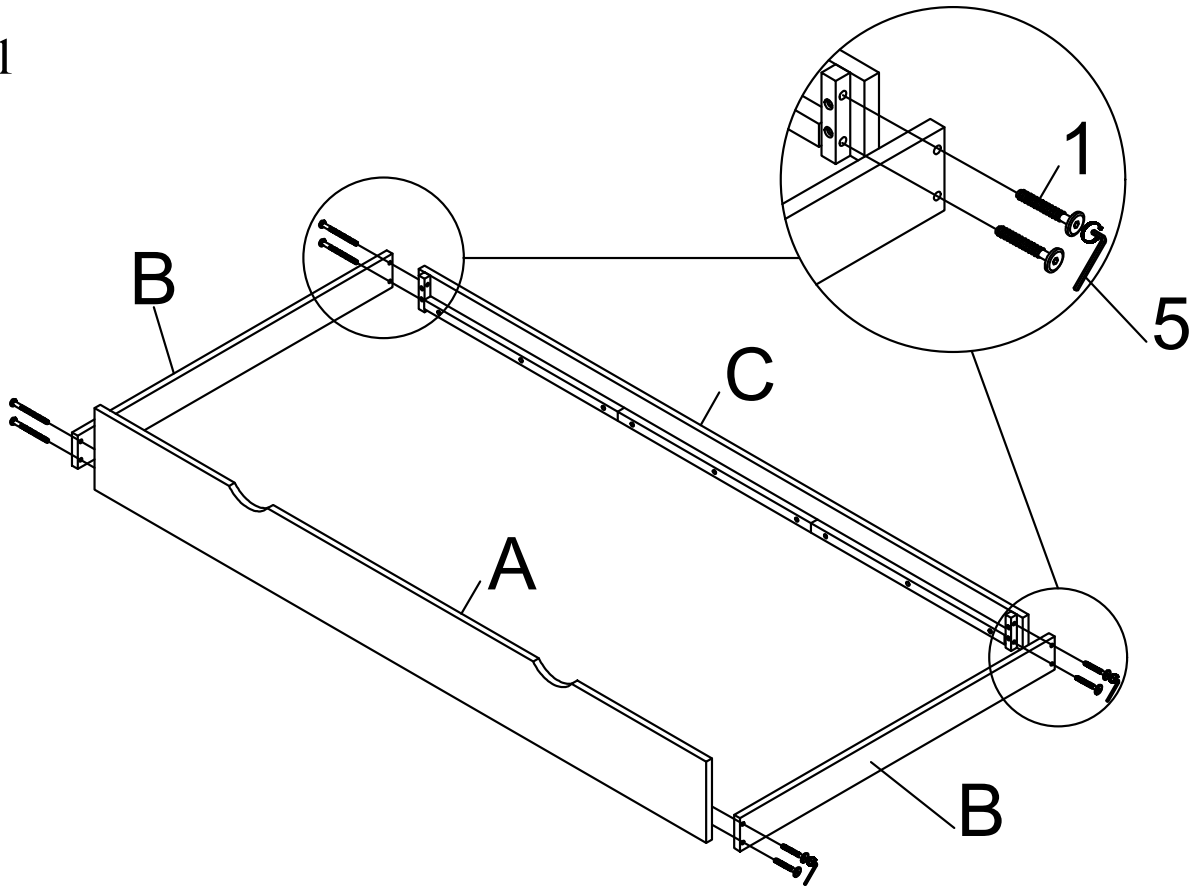

STEP 2

