



USER'S MANUAL
Adjustable Base
HW67765/HW67766





IMPORTANT: Please read all instructions carefully before assembling and using this product. Keep this **USER MANUAL** for future reference. The specifications of this product may vary from its photos. Pictures are for reference only, products are subject to actual products.

IMPORTANT SAFETY INFORMATION

Please read this manual carefully before assembling and using the adjustable bed. Only when the bed is properly assembled, maintained, and used, can it be used safely and effectively. Please keep the instruction manual for future reference.

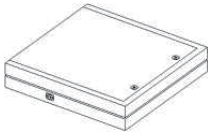
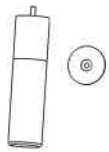
1. This adjustable bed is designed for indoor use only.
2. This adjustable bed is designed for adults. This is dangerous for children or pets. When children or pets are in or near the bed, adults must carefully watch over them.
3. Please ensure you connect the base properly to the power supply. It is wiser and safer to unplug the bed's plug from the socket when you want to disconnect the power. Pull the bed's plug out of the socket before any cleaning or maintenance of the bed. And keep the power cord away from hot surfaces.
4. The lift motor is lubricated and sealed without additional lubrication. Do not apply lubricant to the lifting motor screws or any nylon nuts. If there's any problem with the motor of the bed, please contact us directly in time.
5. We recommend two or more people to move the bed base after you have assembled the bed. Because It's easy to get hurt if you move alone due to its heavy weight.
6. Do not sit, stand or jump on the head or foot sections of the base during the operation of the bed base. The weight should be evenly distributed across the bed base.
7. The maximum load of the bed is 850lbs.

PARTS LIST

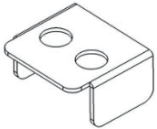
<p>A The bed base x1</p> 	<p>B Legs and Washer x6</p> 	<p>C Mattress Retainer x2</p> 
<p>D Handset x1</p> 	<p>E Adaptor x1</p> 	<p>F Middle Leg Fastener (used for preventing the base from folding while moving) x2</p> 

After opening the box, check the packing lists to make sure you have received all the necessary parts to assemble the bed frame.

When you unpack and prepare for assembly, place the product on a carpeted or padded area to prevent damage.

ASSEMBLY INSTRUCTIONS

1

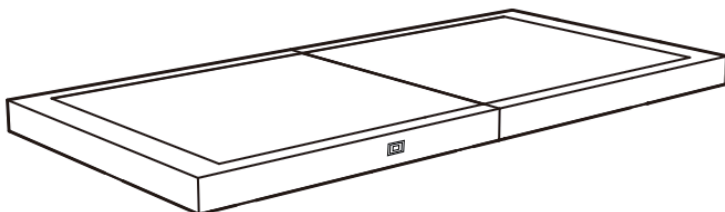

A. Unfold the bed base (A) to full extension.

2

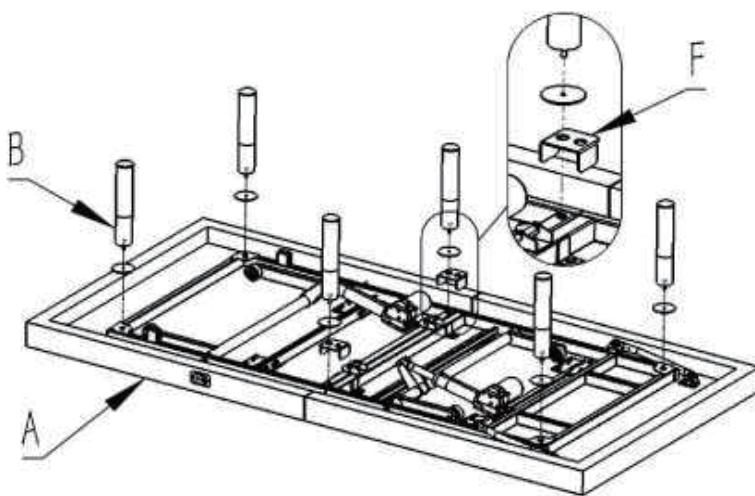

A. Put the base (A) in an upside down position. (It is recommended that at least two people turn it over to prevent injury.)

B. Assemble 4 corner legs respectively.

C. Put the middle leg into the middle leg fastener (F) to prevent the base from folding while moving. Then attached the middle legs respectively.

Note: Please install the middle leg fastener as the picture shown

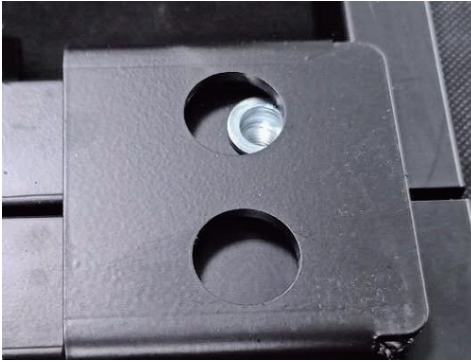

Optional Leg Height:
Three Different Leg Heights to Fit Most Bed Frames.
4 inches, 7 inches, and combined for 11 inches.

3

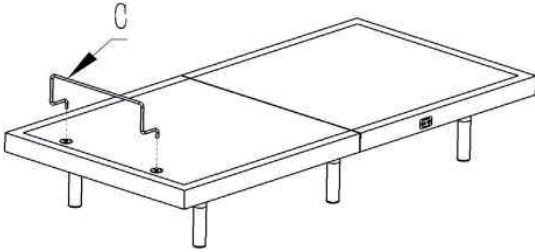

A. Flip the base over, put the mattress retainer(C) on.

NOTE: The mattress retainer(C) is not to be used to lift the base

4

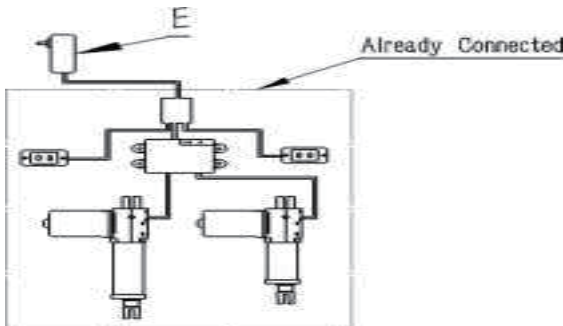



A. Uncoil the input power cord (connected to the control box's power port) and plug it into the power supply.



B. Uncoil the power cord and connect it to the power supply.

PLEASE NOTE: you only need to connect the adaptor (E). Other wires are already connected.







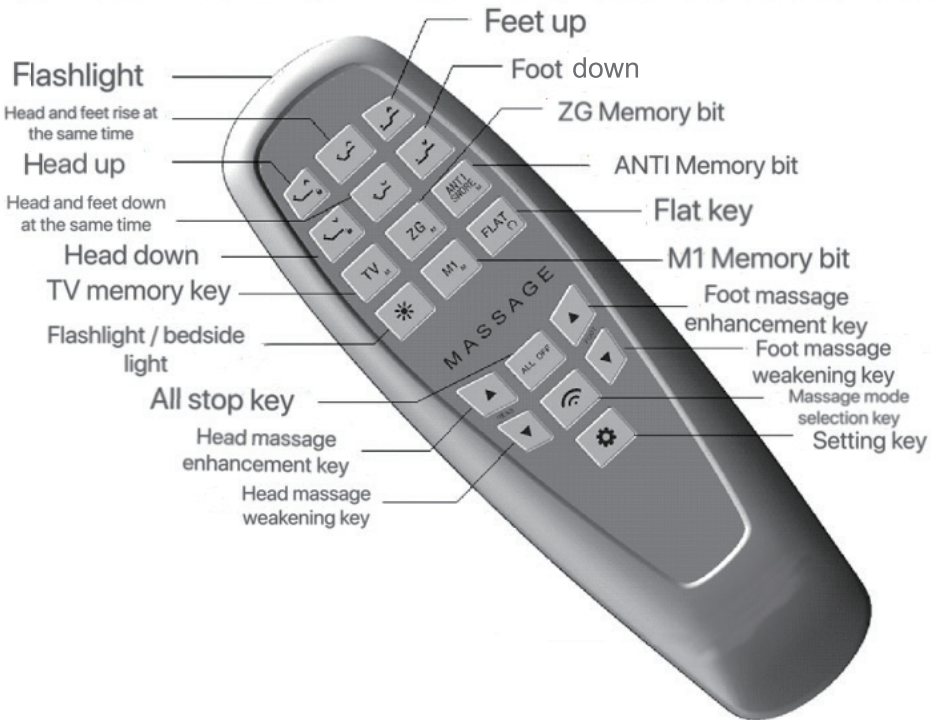

Cleaning & Maintenance

Clean the surface with a dry or wet soft cloth. Do not wipe with large amounts of water. After scrubbing, keep it ventilated and dry, do not expose to the sun. Make sure the motor control system is well connected before use. Please cut off the power if the bed base isn't used for a long time.

INSTRUCTION MANUAL



Key combination function

Key combination	function
	When the control box is in the code matching state, hold for 3 seconds, the buzzer will sound once, and the remote control and the control box are paired successfully.
	Hold for 3 seconds, the buzzer rings for a short time, and the TV position memory is successful
	Hold for 3 seconds, the buzzer rings for a short time, and the ZG position memory is successful
	Hold for 3 seconds, the buzzer rings for a short time, and Anti Snore position memory is successful
	Hold for 3 seconds, the buzzer rings for a short time, M1 position memory is successful
	Keep it for 3 seconds, the buzzer will sound for a short time, and the children's lock will be locked. When locking, massage, flashlight and bedside lamp can be used normally
	Hold for 3 seconds, the buzzer will sound for a short time, and the child lock will be unlocked
	Hold for 3 seconds, the buzzer will ring for a short time, and all memory bits will return to the factory settings

Detailed Description

1. Connect and power on

The motor and massager are inserted into the corresponding sockets according to the instructions on the control box. Connect the control box with the switching power supply with the connecting wire, and then the switching power supply is powered on. At this time, the control box detects and automatically runs the head and feet to the flat position, then the buzzer rings and the indicator light flashes. At this time, the control box is in the code matching state. The code matching status of the control box lasts about 10 seconds. During this time, the remote control is operated for pairing. When the buzzer rings, the pairing is successful. If code matching is not required at this time, the indicator light stops flashing after 10 seconds, indicating that the control box is in standby mode. When the remote control and the control box are paired successfully, they can be used normally.

2. Key operation and function description

 Click the button and then release, the head and feet will automatically run to the set position, and press any key during the operation to stop running.

 Keep pressing the key and the head will rise. Release the key to stop the operation.

 Press and hold the head button and keep falling. Release the key to stop the operation.

 Press and hold the button continuously, and the head and feet rise at the same time. Release the key to stop the operation.



Press and hold the key continuously, and the head and feet will descend at the same time. Release the key to stop the operation.



Press and hold the key and the foot rises. Release the key to stop the operation.



Press and hold the key continuously to lower the foot. Release the key to stop the operation.



Press and hold the button continuously, and the flashlight on the top of the remote control will be on. Release the button and the flashlight is off.

FLAT Click the button and then release, the head and feet will automatically drop to the flat position, and press any key during the operation to stop the operation.



Click the button and then release, the head massage function is activated, and the intensity is the strongest gear. When the beeper is in the third gear, the beeper will sound the strongest.



Click the button and then release, the head massage function will be weakened. If you click the button again, the message intensity will continue to decrease, with a total of 3 levels. When the weakest position is reached, the message function will stop and the buzzer will sound to indicate that it has been turned off.

ALL OFF Click the button and then release, all functions stop running.



There are four message modes: 0: continuous working; 1: working for 0.3 seconds and stopping for 0.3 seconds; 2: working for 0.6 seconds and stopping for 0.6 seconds, such a cycle; 3: working for 1 second, stopping for 1 second, and so on.



Click the button and then release, the foot massage function is activated, and the intensity is the strongest gear. When the beeper is in the third gear, the beeper will sound the strongest.



Click the button and then release, the foot massage function will weaken. If you click again, the message intensity will continue to decrease, with a total of 3 levels. When you click the button again, the message function will stop and the buzzer will sound to indicate that it has been turned off.



Combination function key, press the button with buttons with small icon in the lower right corner at the same time.

Other instructions

1. When you press any key on the remote control, the backlight of the remote control lights up for about 3 seconds and then goes out automatically.
2. When the message function is running, if the operation driver is running, the message function will continue to run.
3. The overload protection function is designed inside the control box, and the overload protection current is 4.5A.