







# Assembly Instruction

## PARTS LIST

A.Front panel		1	E.'L' joint		4
B.Side panel		2	F.Handle		1
C.Rear side panel		1			
D.Bottom panel		1	G.Wood screw		2

1.Insert the 4\*'L' joint(Parts"E") into both sides of rear side panel(Parts"C")

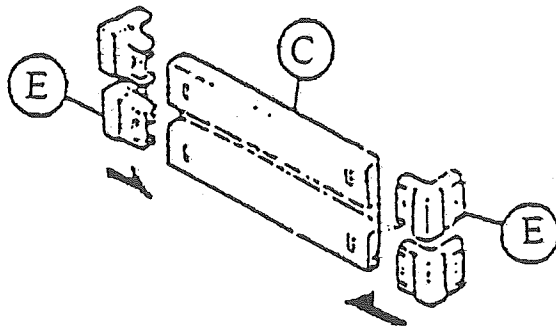

2.Put side panel onto 'L' joint on both sides(Parts"B") of rear panel and fix.  
(Note:Groove on both rear and side panel should be facing down)

3.Put in bottom panel along groove of the rear (white side up),  
insert rear panel to the 'E' fixture on the front.

4.Screw (G\*2) handle on front panel.

