

20 min

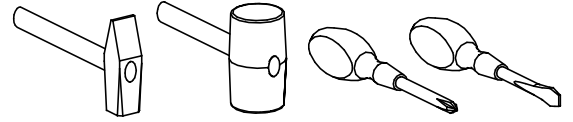

# KYOTO

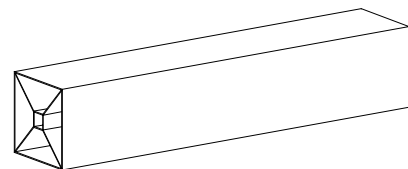
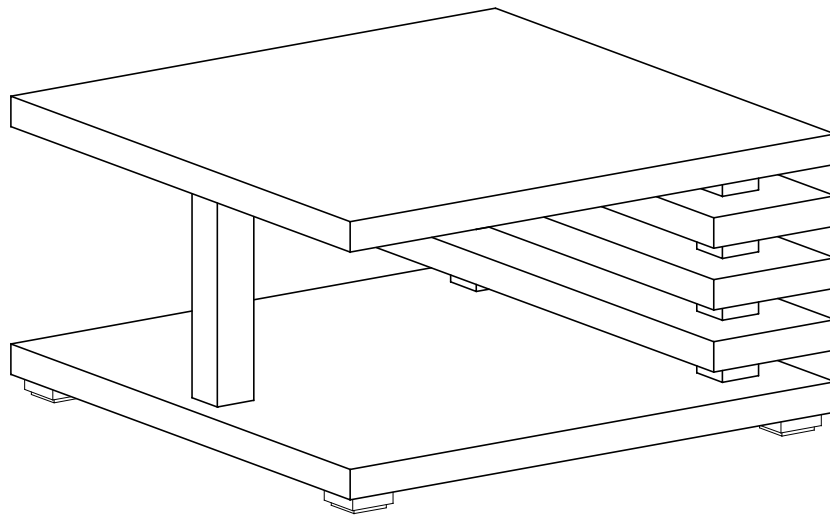
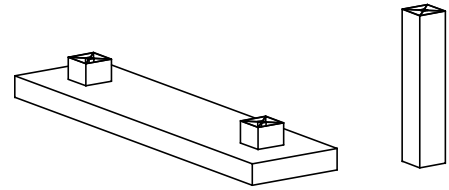

S - 1 St.

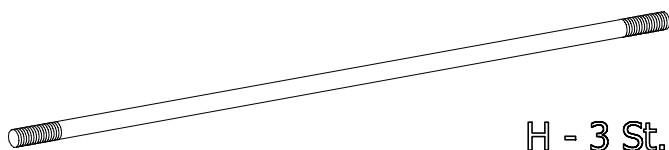

H - 3 St.

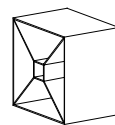

G - 8 St.

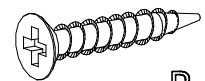

R - 16 St.  
4 x 30 mm



B - 3 St.



F - 3 St.

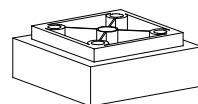

P - 4 St.

