

ASSEMBLY INSTRUCTION

WF316202

WF316203

WF316204

WF316205

Friendly Reminder:

- 1.This sofa is packed in 4 boxes. Please assemble it After all boxes are received.
- 2.As the cushions are all vacuum compressed,there will be some wrinkles. Please give your cushions up to 72 hours to reach its original size and the wrinkles will basically disappear.
- 3.Please do not open the compressed packags until your sofa frame is completely assembled.

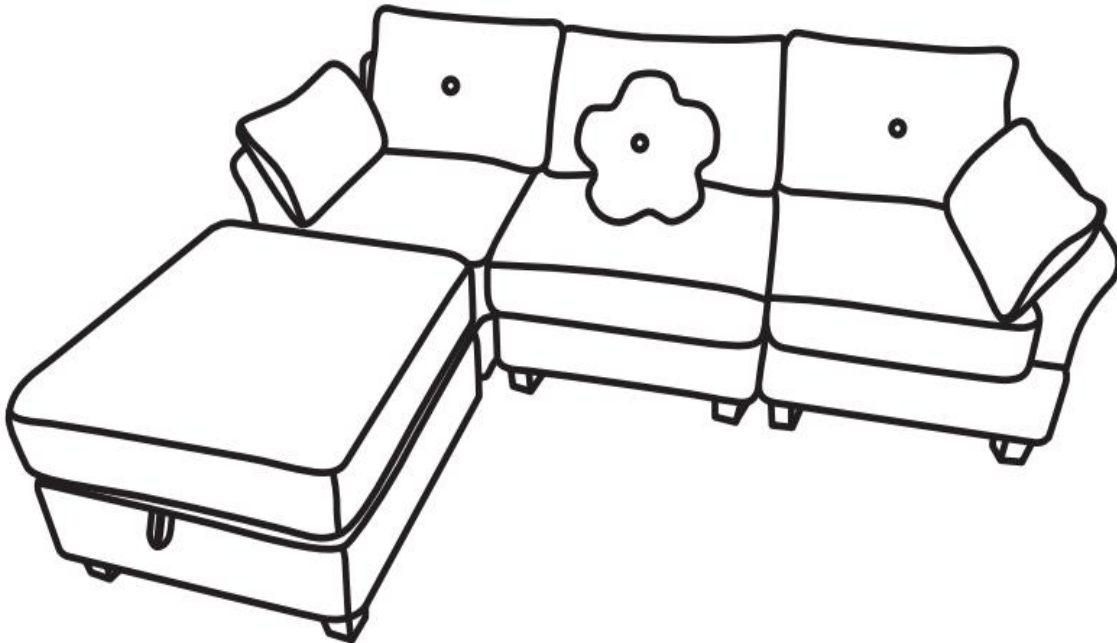





Return & warranty policy

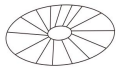

- we strive to offer the highest quality products , and we also try our best to satisfy each and every customer that orders from us with replacement parts or service as needed.
- If the item is damaged or defective , please take photos as evidence for replacements and refunds.
- please do not return to store , contact the seller if you have any troubles with this product.

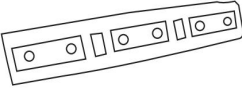
ASSEMBLY INSTRUCTION

HARDWARE WF316202



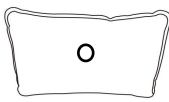

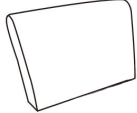
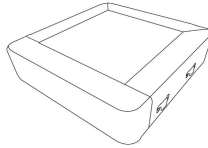
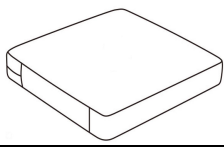
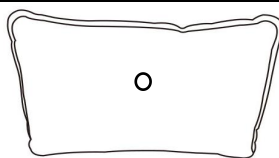
NO	DESCRIPTION	SKETCH	QTY
1	Plastic gasket		4
2	Felt mat		4
3	Inserts		4
4	Usb plug		1

PART LIST WF316202

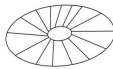

NO	DESCRIPTION	SKETCH	QTY
A	Main leg		4
B	Backrest pillow		1
C	Left armrest		1
D	Backrest		1
E	Left seat frame		1
F	Seat cushion		1
I	Backrest pillow (big)		1

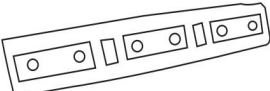
ASSEMBLY INSTRUCTION

HARDWARE WF316203

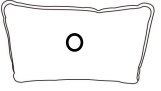
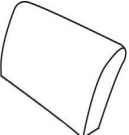
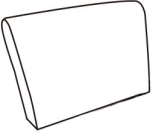
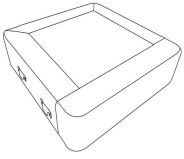
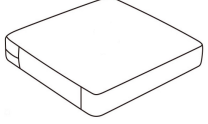

NO	DESCRIPTION	SKETCH	QTY
1	Plastic gasket		4
2	Felt mat		4
3	Inserts		4
4	Usb plug		1

PART LIST WF316203

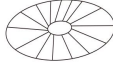

NO	DESCRIPTION	SKETCH	QTY
A	Main leg		4
B	Backrest pillow		1
G	Right armrest		1
D	Backrest		1
H	Right seat frame		1
F	Seat cushion		1
L	Armrest pillow		1

ASSEMBLY INSTRUCTION

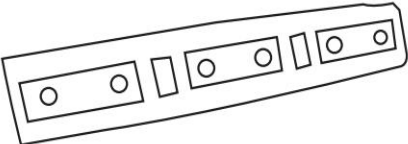
HARDWARE WF316204

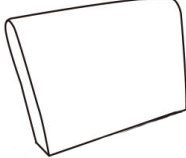
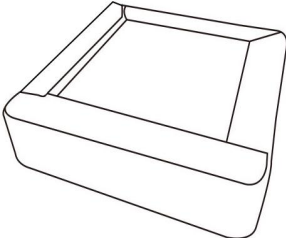
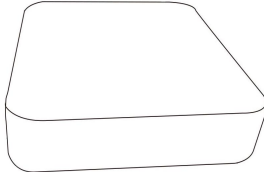

NO	DESCRIPTION	SKETCH	QTY
1	Plastic gasket		4
2	Felt mat		4
3	Inserts		2

PART LIST WF316204

NO	DESCRIPTION	SKETCH	QTY
A	Main leg		4
D	Backrest		1
J	Middle seat frame		1
K	Middle seat cushion		1
L	Armrest pillow		1

ASSEMBLY INSTRUCTION

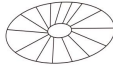
HARDWARE WF316205

NO	DESCRIPTION	SKETCH	QTY
1	Plastic gasket		4
2	Felt mat		4

PART LIST WF316205

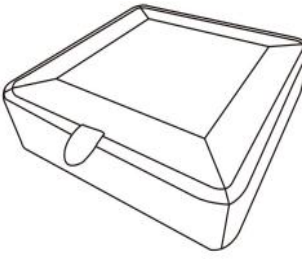
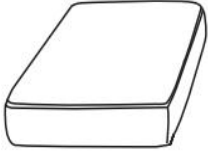
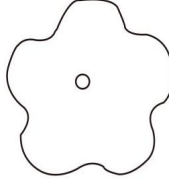
NO	DESCRIPTION	SKETCH	QTY
A	Main leg		4
N	Ottoman seat frame		1
M	Ottoman seat cushion		1
O	Flower pillow		1

ASSEMBLY INSTRUCTION

All parts and hardwares

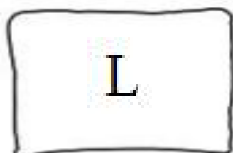
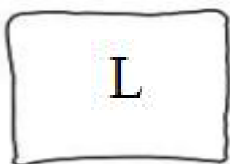
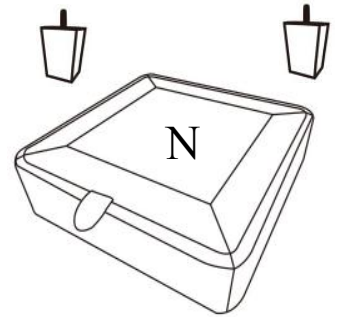
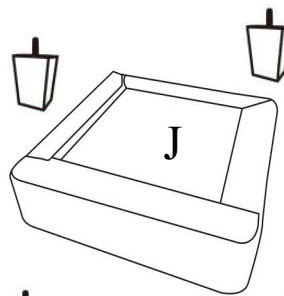
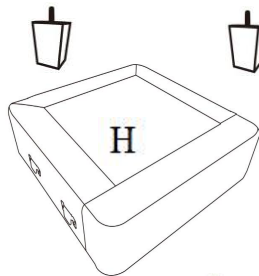
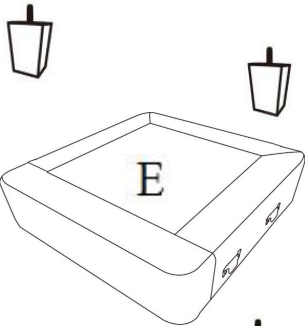
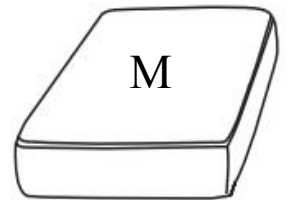
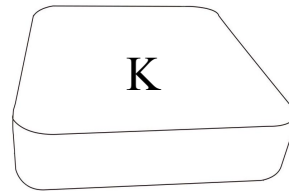
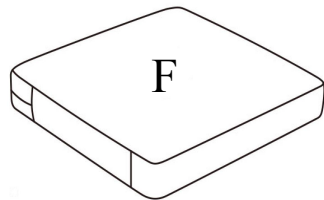
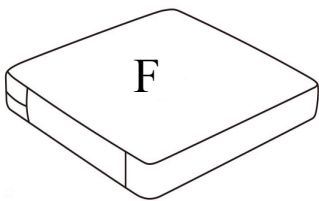
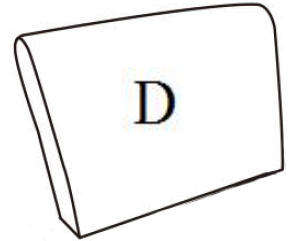
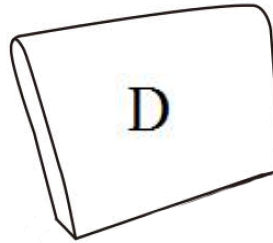
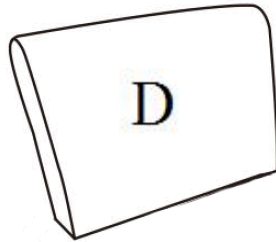
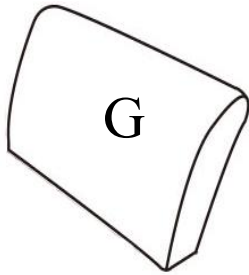
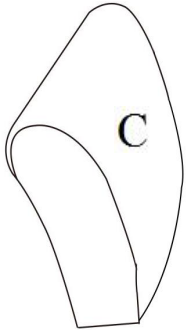
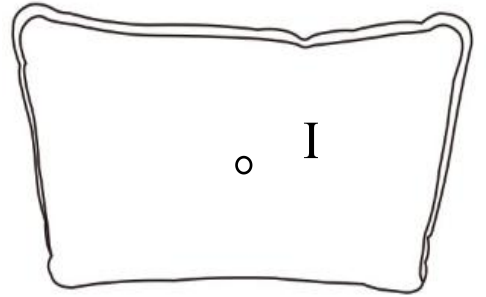
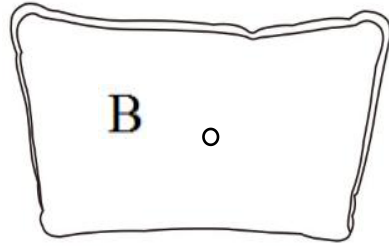
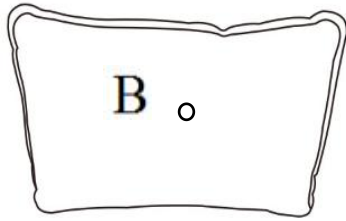

1		16
2		16
3		10
4		2

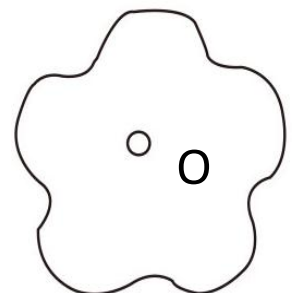

ASSEMBLY INSTRUCTION

WF316202

DIAGRAM 1 (Take out all parts from carton WF316202)

Take the Main legs (Part A), Backrest pillow (Part B), Left Armrest (Part C), Seat cushion (Part F), Backrest pillow (big) (Part I) out of the Left seat frame (Part E).

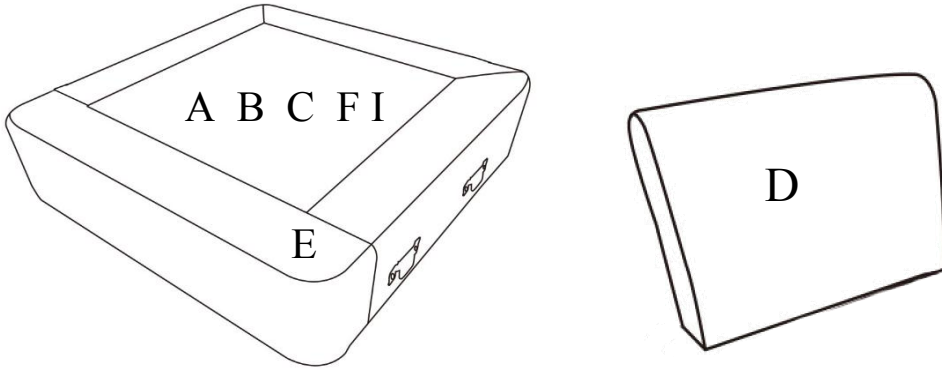







①		4
②		4
③		4
④		1

DIAGRAM 2 (Assemble the Backrest and the Left armrest)

Insert the Backrest (Part D) and the Left armrest (Part C) with 4 Inserts (HARDWARE 3) .

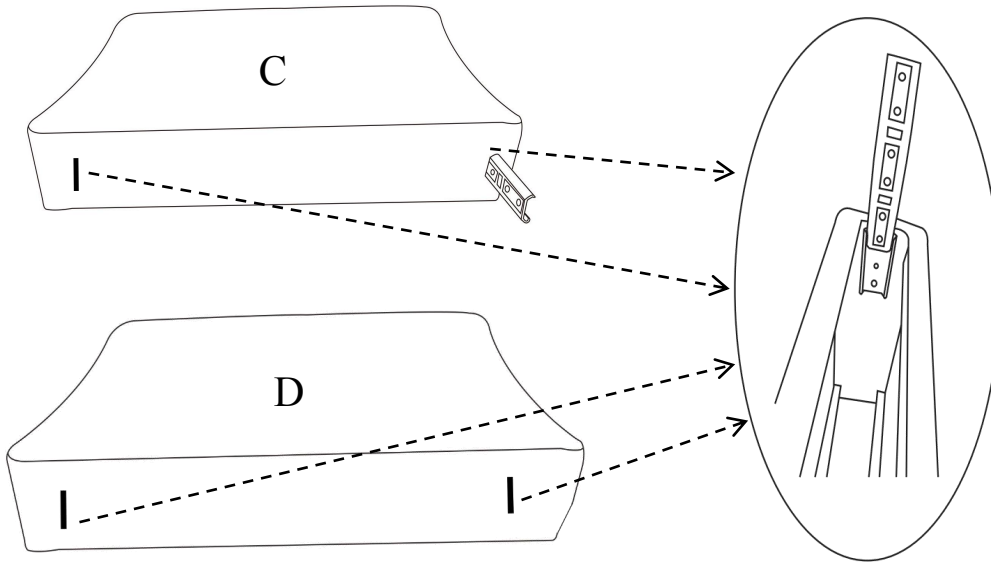

③		4
---	---	---

ASSEMBLY INSTRUCTION

WF316202

DIAGRAM 3 (Assemble the Backrest and the Left armrest)

Insert the Backrest (Part D) and the Left armrest (Part C) to the Left seat frame (Part E) .

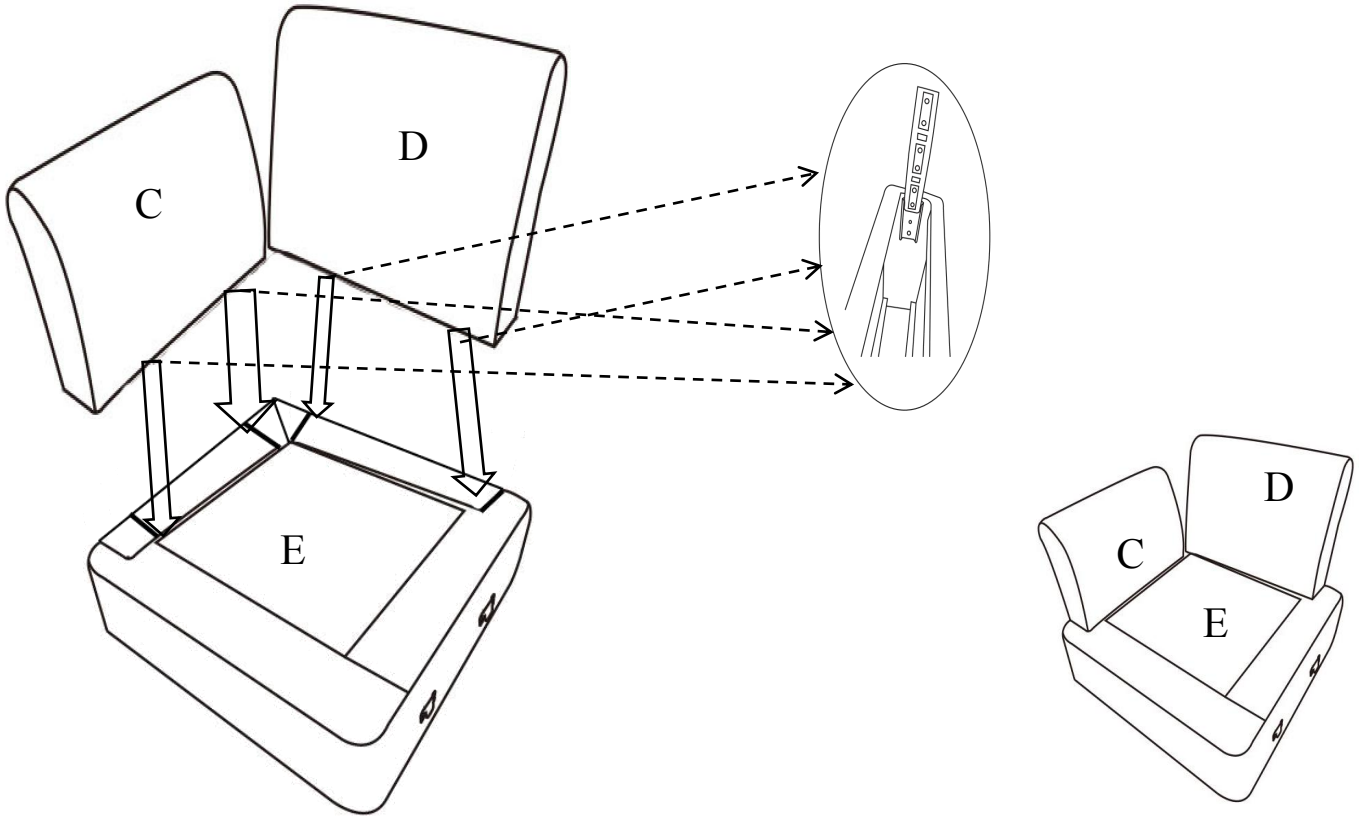
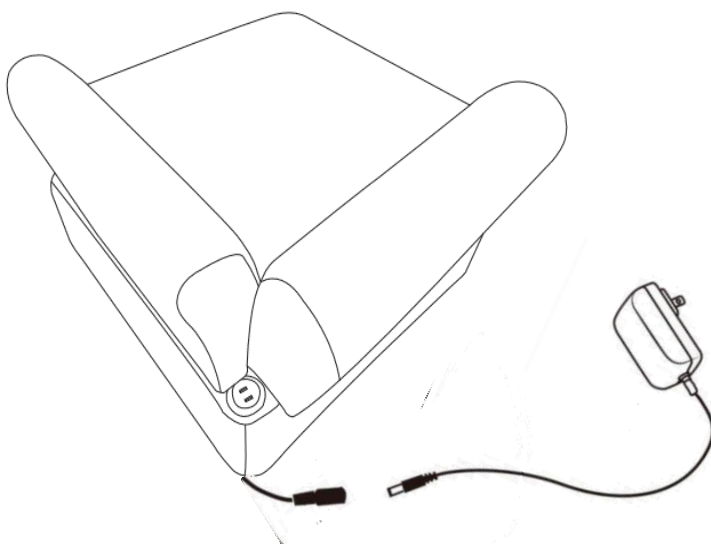

DIAGRAM 4 (Assemble the Usb plug)

Connect the Usb plug (HARDWARE 4).

④		1
---	---	---



ASSEMBLY INSTRUCTION

WF316202

DIAGRAM 5

Use scissors to open the vacuum sealed Seat cushion (Part F). It may take 24-72 hours to fully expand back to its original shape and firmness.

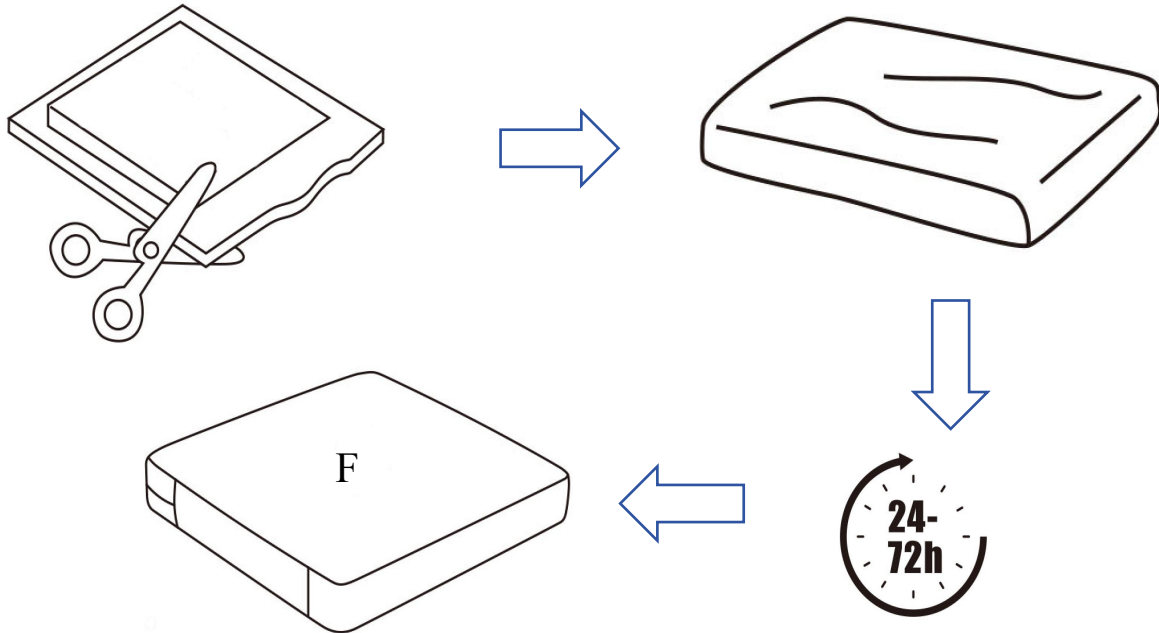
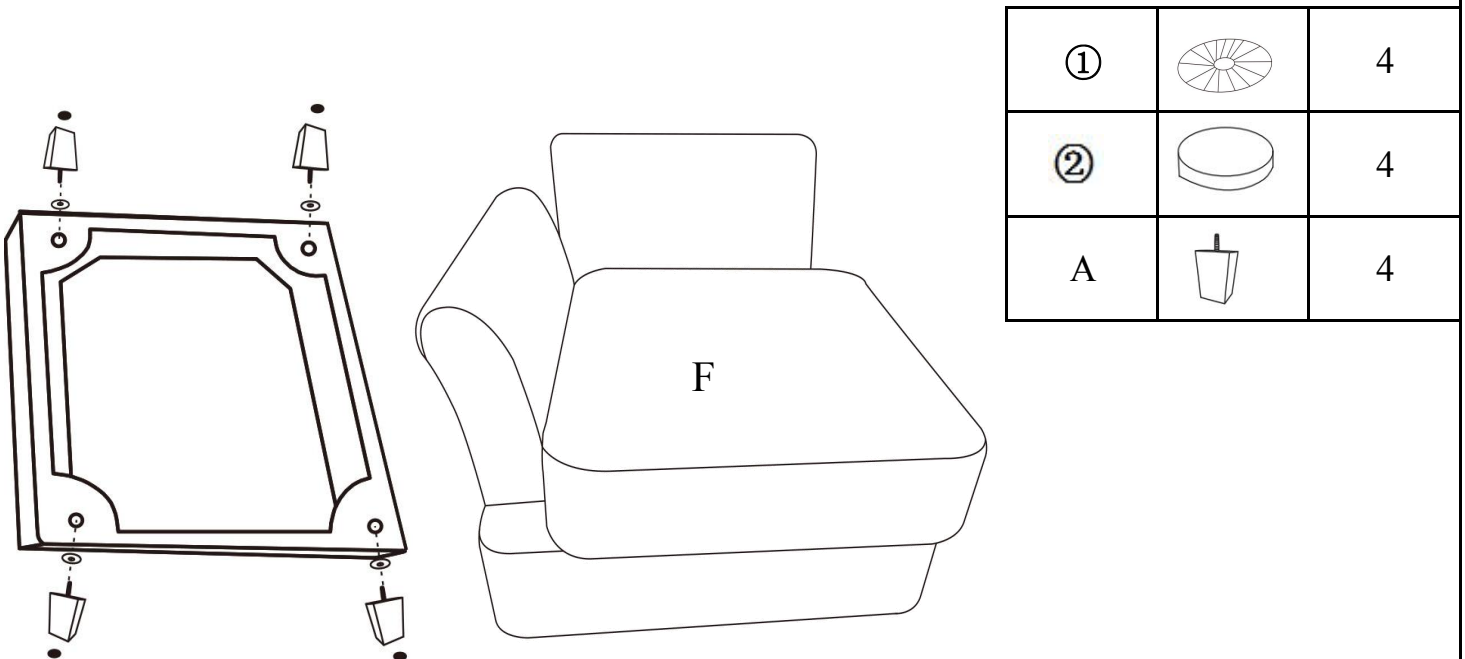

DIAGRAM 6

Tighten Main legs (Part A) by 4 Plastic gaskets (HARDWARE 1) . And then stick the 4 Felt mats (HARDWARE 2) under the Main legs (Part A). Put the Seat cushion (Part F) on the seat.



ASSEMBLY INSTRUCTION

WF316203

DIAGRAM 1 (Take out all parts from carton WF316203)

Take the Main legs (Part A), Backrest pillow (Part B), Right armrest (Part G), Seat cushion (Part F), Armrest pillow (Part L) out of the Right seat frame (Part H).

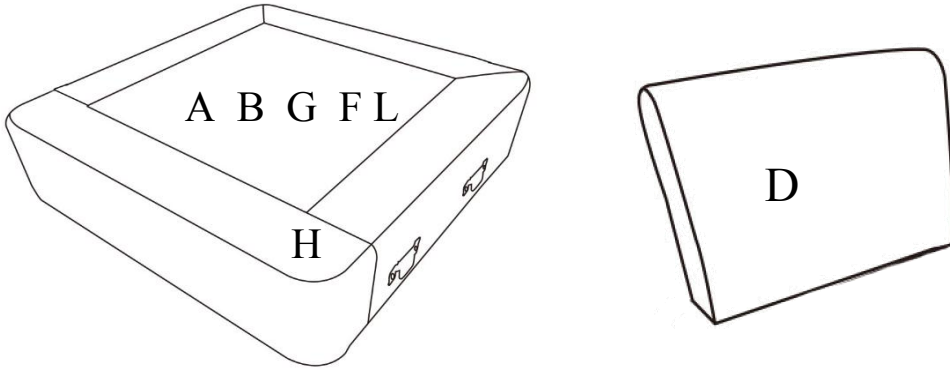







①		4
②		4
③		4
④		1

DIAGRAM 2 (Assemble the Backrest and the Right armrest)

Insert the Backrest (Part D) and the Right armrest (Part G) with 4 Inserts (HARDWARE 3) .

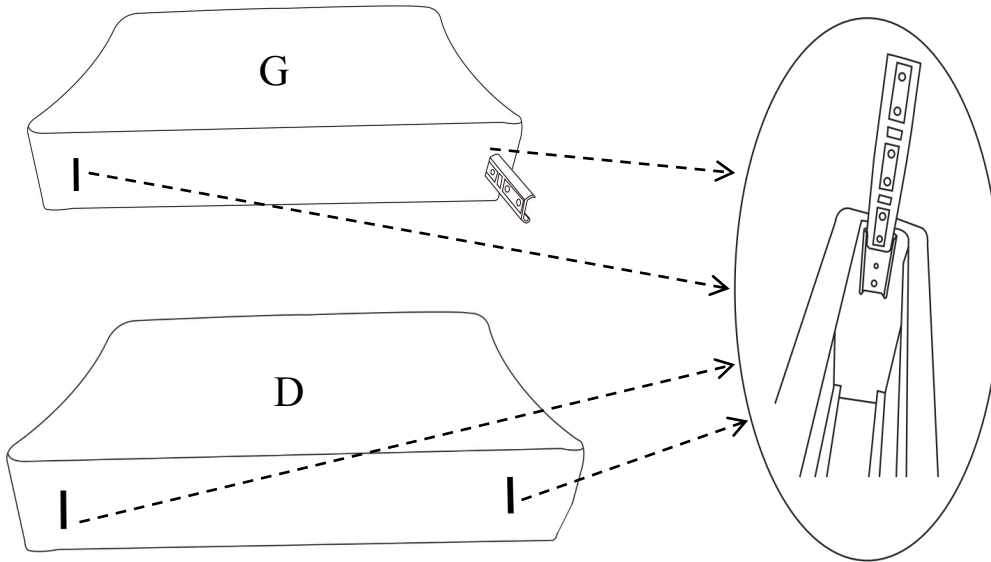

③		4
---	---	---

ASSEMBLY INSTRUCTION

WF316203

DIAGRAM 3 (Assemble the Backrest and the Right armrest)

Insert the Backrest (Part D) and the Right armrest (Part G) to the Right seat fream (Part H) .

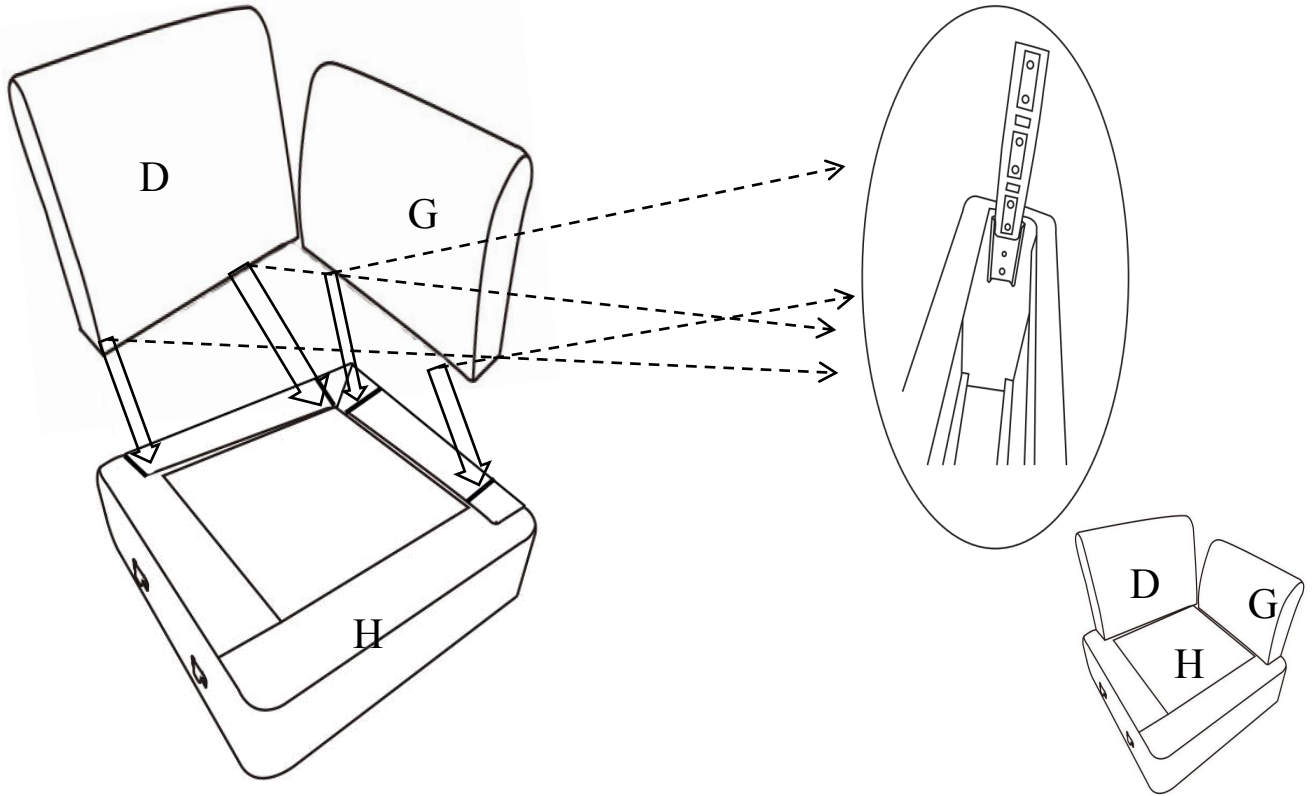
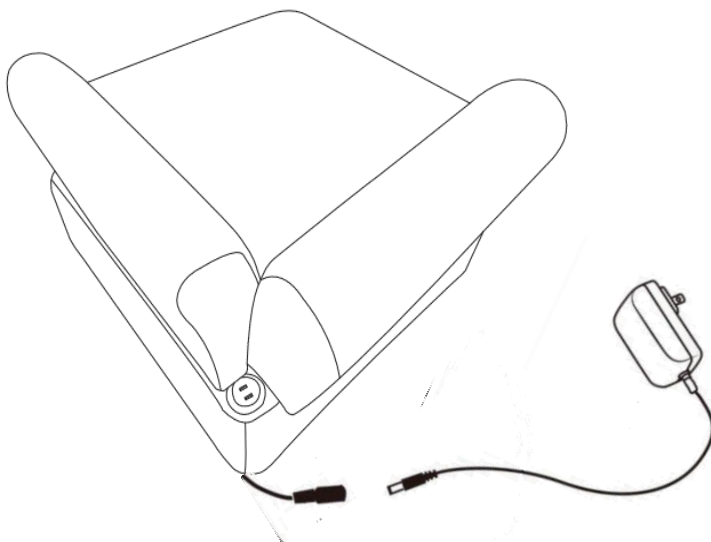

DIAGRAM 4 (Assemble the Usb plug)

Connect the Usb plug (HARDWARE 4).

④		1
---	---	---



ASSEMBLY INSTRUCTION

WF316203

DIAGRAM 5

Use scissors to open the vacuum sealed Seat cushion (Part F). It may take 24-72 hours to fully expand back to its original shape and firmness.

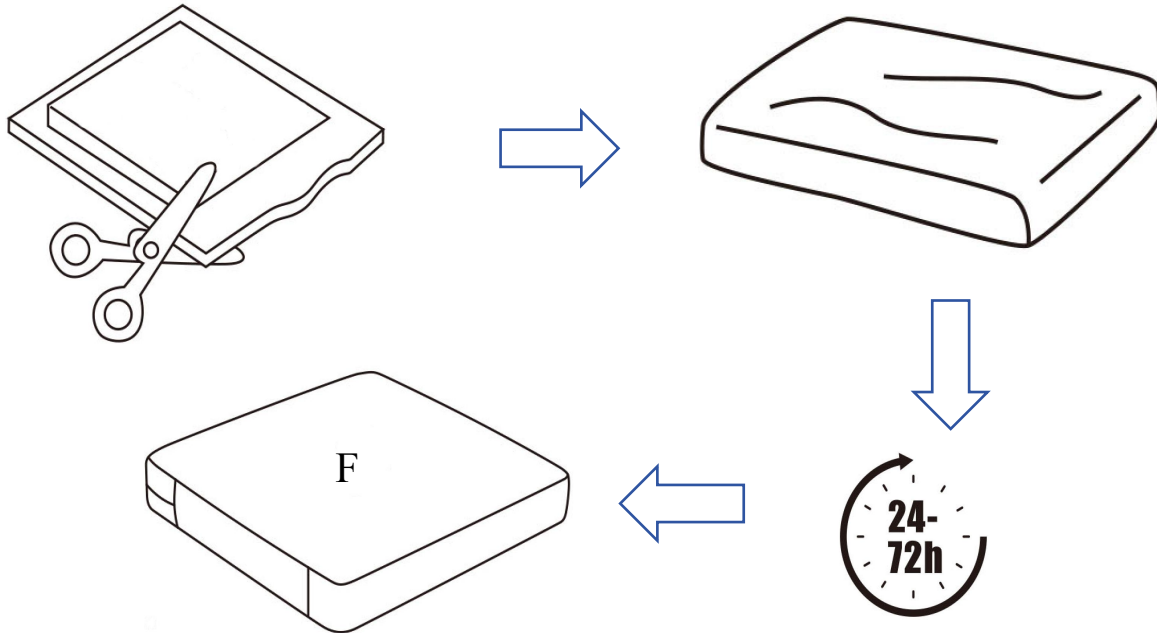
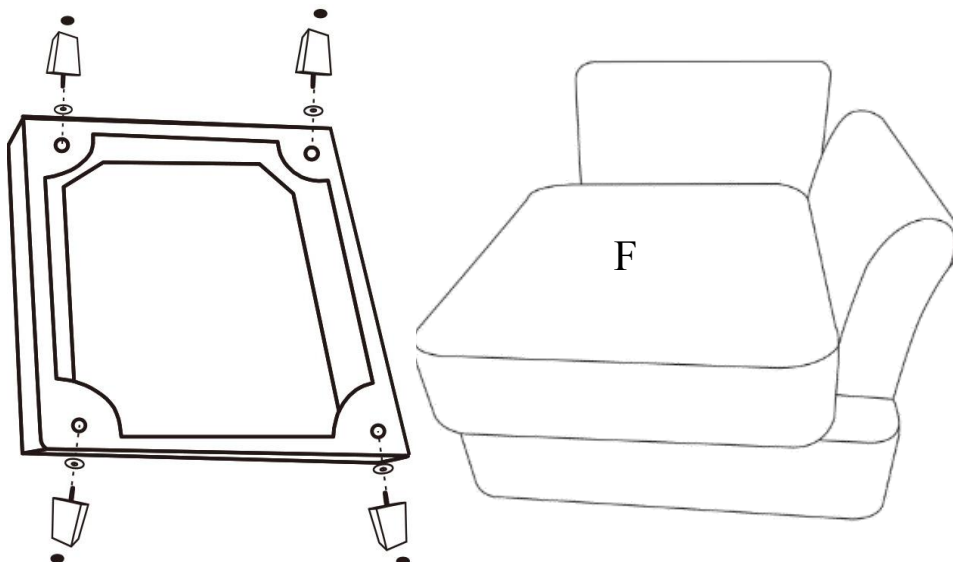
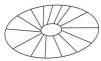



DIAGRAM 6

Tighten Main legs (Part A) by 4 Plastic gaskets (HARDWARE 1) . And then stick the 4 Felt mats (HARDWARE 2) under the Main legs (Part A). Put the Seat cushion (Part F) on the seat.



①		4
②		4
A		4

ASSEMBLY INSTRUCTION

WF316204

DIAGRAM 1 (Take out all parts from carton WF316204)

Take the Main legs (Part A), Armrest pillow (Part L), Middle seat cushion (Part K) out of the Middle seat frame (Part J).

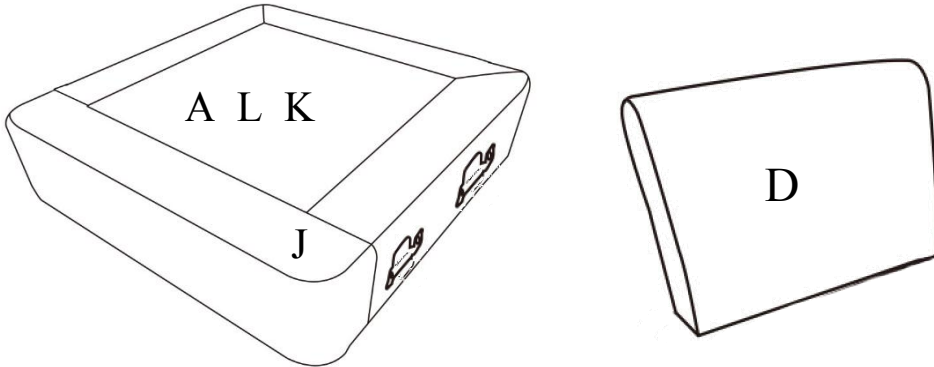





①		4
②		4
③		2

DIAGRAM 2 (Assemble the Backrest)

Insert the Backrest (Part D) with 2 Inserts (HARDWARE 3).

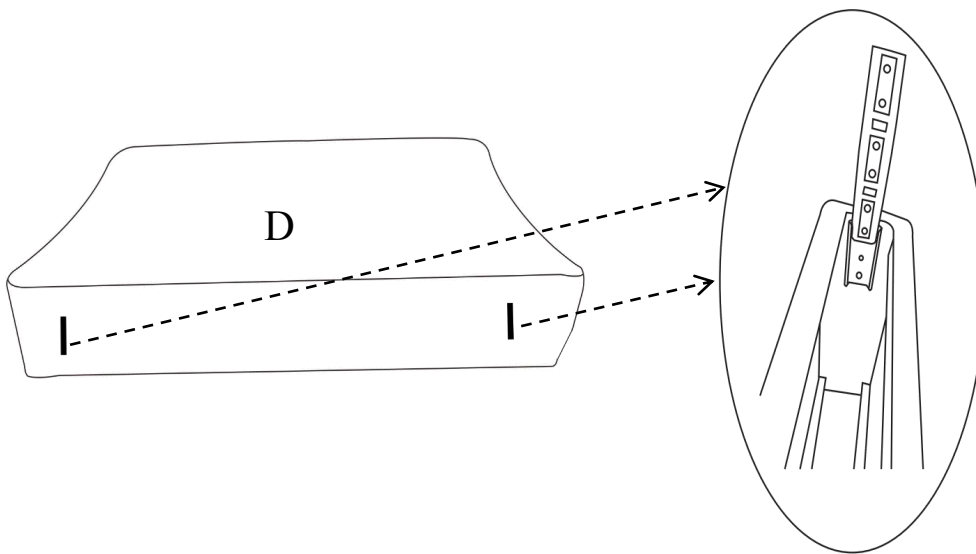

③		2
---	---	---

ASSEMBLY INSTRUCTION

WF316204

DIAGRAM 3 (Assemble the Backrest)

Insert the Backrest (Part D) to the Middle seat fram (Part J) .

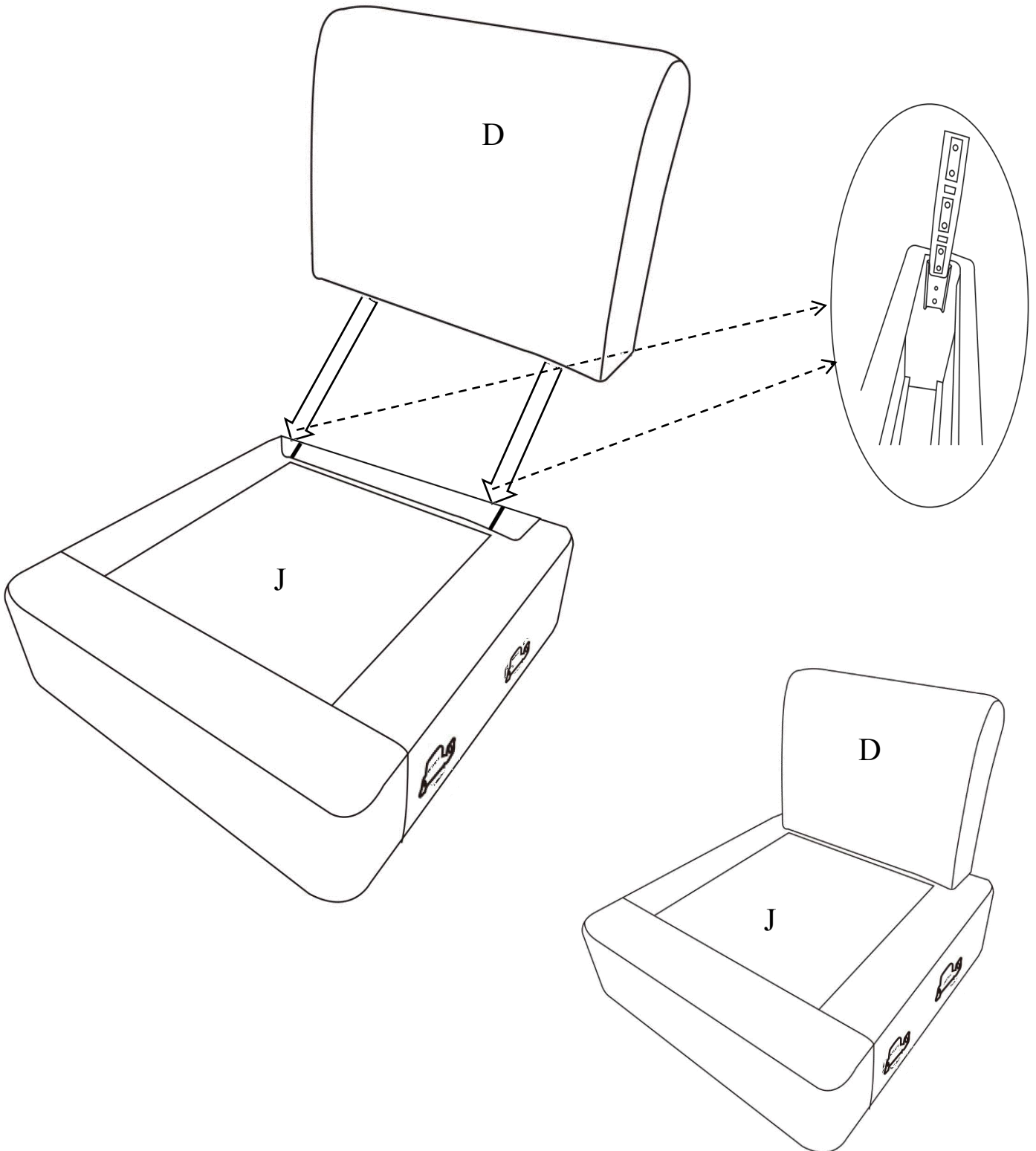

ASSEMBLY INSTRUCTION

WF316204

DIAGRAM 4

Use scissors to open the vacuum sealed Seat cushion (Part K). It may take 24-72 hours to fully expand back to its original shape and firmness.

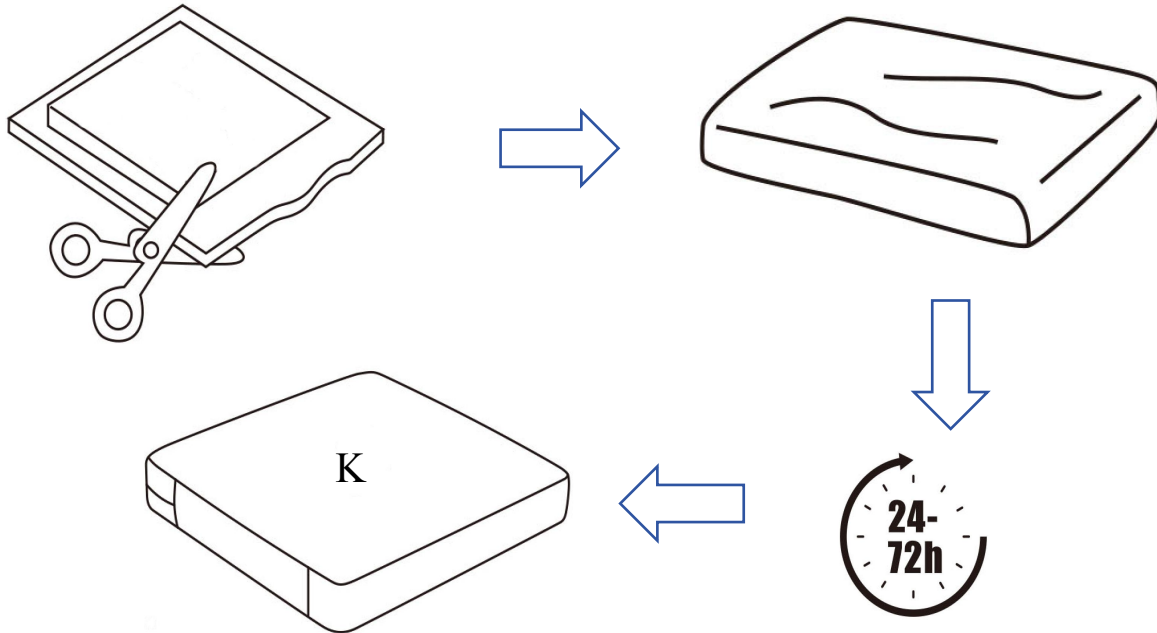
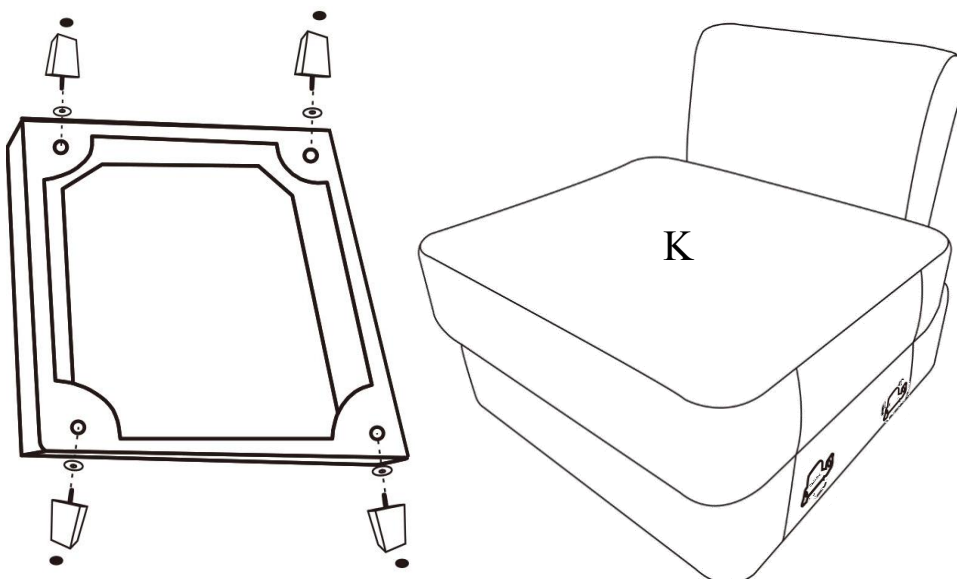
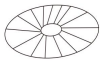



DIAGRAM 5

Tighten Main legs (Part A) by 4 Plastic gaskets (HARDWARE 1) . And then stick the 4 Felt mats (HARDWARE 2) under the Main legs (Part A). Put the Seat cushion (Part K) on the seat.



①		4
②		4
A		4

ASSEMBLY INSTRUCTION

WF316205

DIAGRAM 1 (Take out all parts from carton WF316205)

Take the Main legs (Part A), Flower pillow (Part O), Ottoman seat cushion (Part M) out of the Ottoman seat frame (Part N).

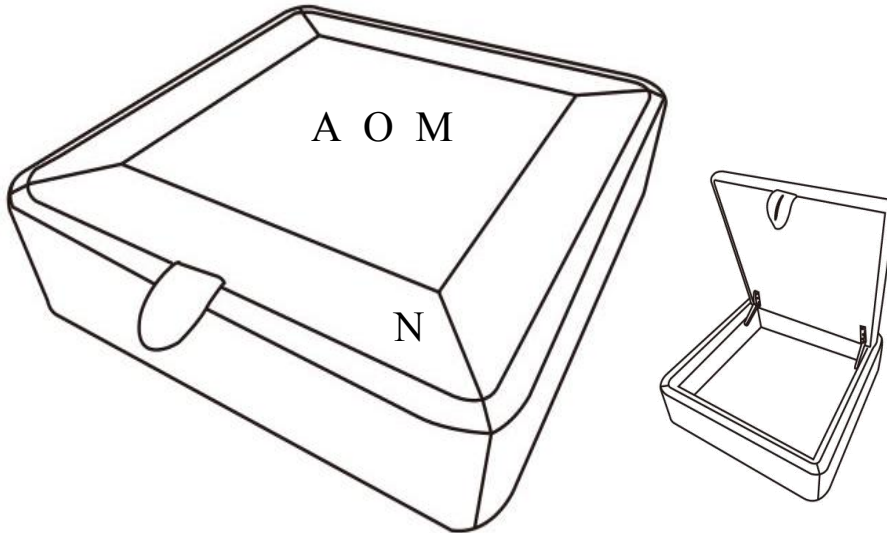

①		4
②		4

DIAGRAM 2

Use scissors to open the vacuum sealed Seat cushion (Part M). It may take 24-72 hours to fully expand back to its original shape and firmness.

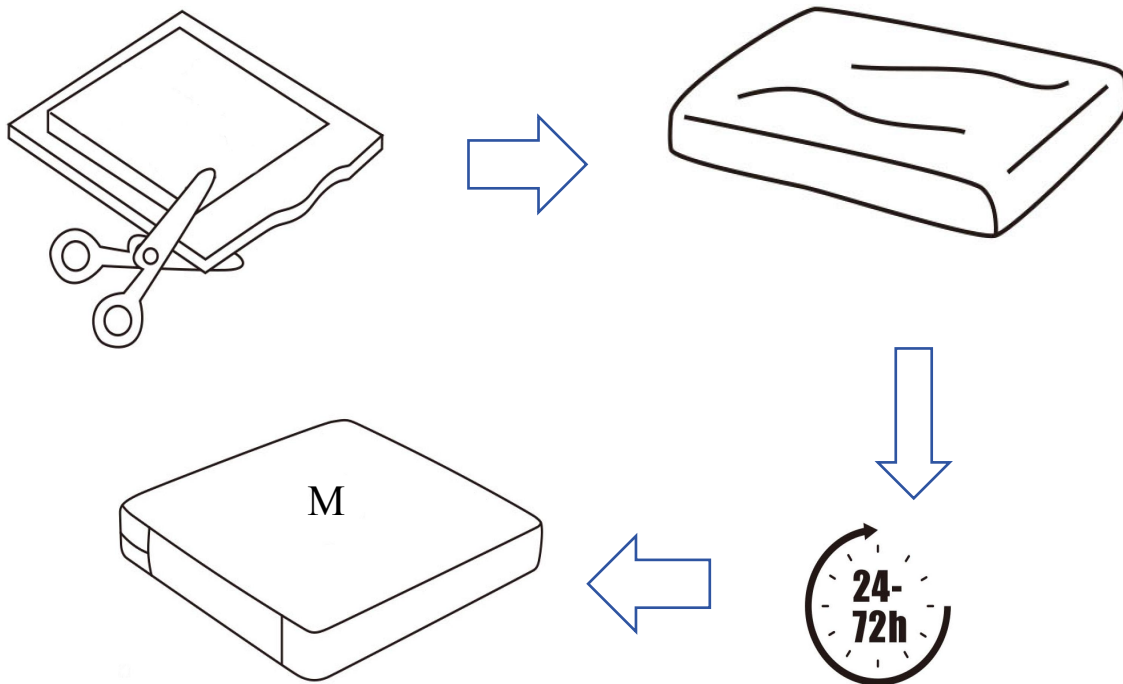

ASSEMBLY INSTRUCTION

WF316205

DIAGRAM 3

Tighten Main legs (Part A) by 4 Plastic gaskets (HARDWARE 1) . And then stick the 4 Felt mats (HARDWARE 2) under the Main legs (Part A). Put the Seat cushion (Part M) on the seat.

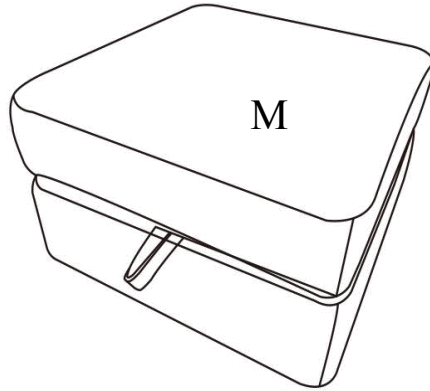
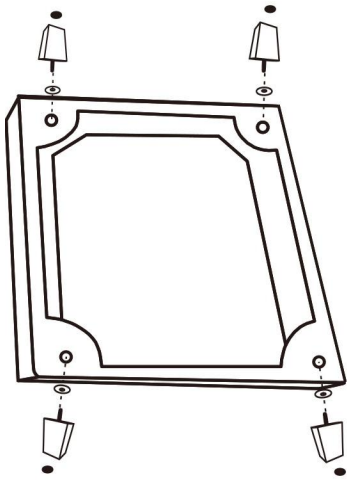



①		4
②		4
A		4

DIAGRAM 4

Put the Armrest pillow (Part L) and the Flower pillow (Part O), the Backrest pillow (Part B) and the Backrest pillow (big) (Part I) like below picture. And then connect the Left seat frame (Part E), the Middel seat fream (Part J) and the Right seat frame (Part H).

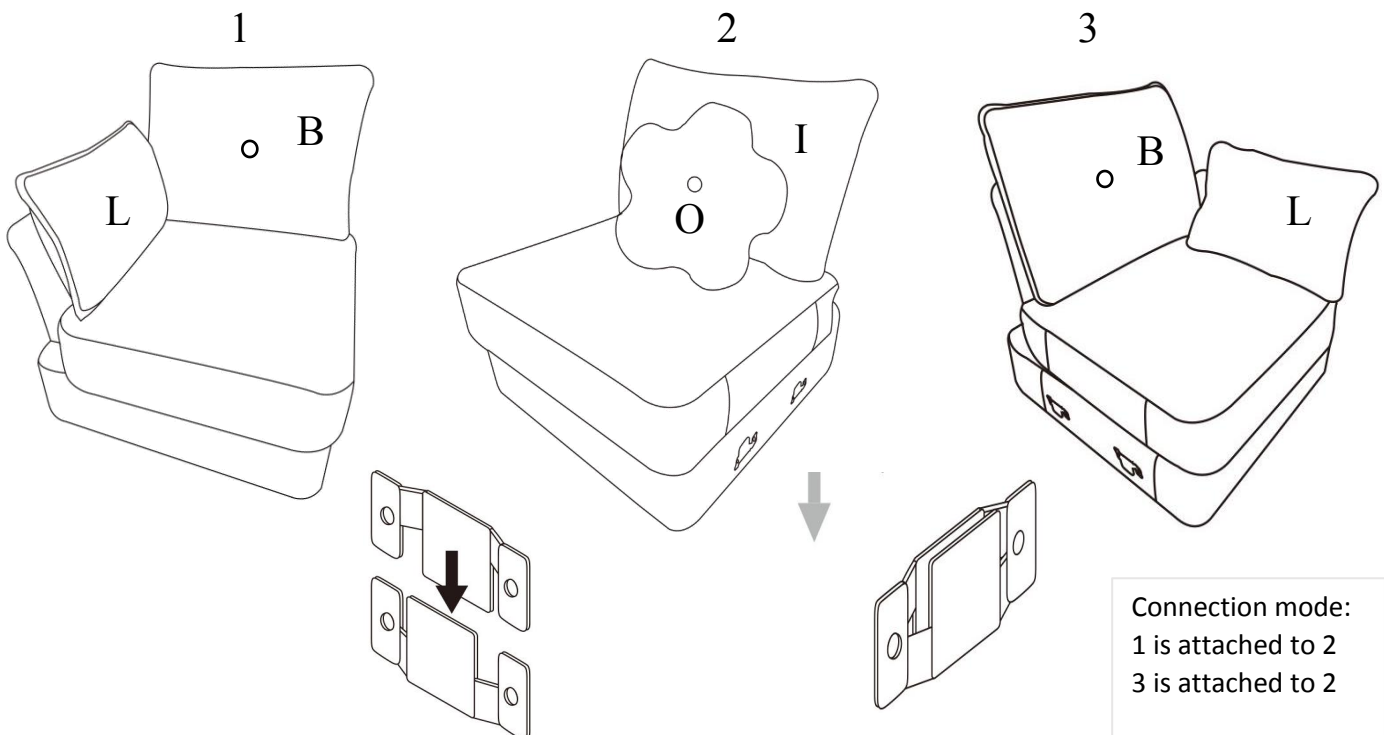

ASSEMBLY INSTRUCTION

TIPS:

1. Please do not open the compress packaging until your sofa frame is completely assembled.
2. Compress back cushions and pillows need to be fully fulfilled within 72 hours for your perfect use.
3. Please keep children away from plastic bags or any small pieces of stuff.

