

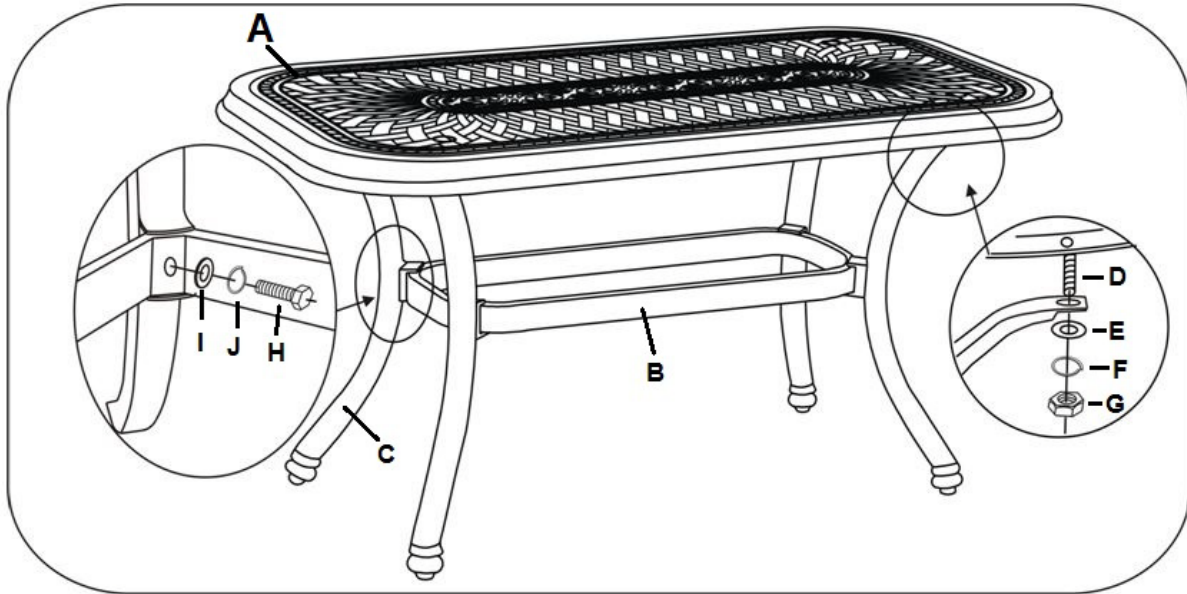







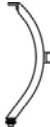

Assembly Instructions

BEFORE YOU BEGIN:

1. Identify all parts in the box against the “Parts” List.
2. Remove all protective material carefully and avoid cutting the surface of the furniture while removing wrapped material.



Part		Description	Qty
A		Table Top	1
B		Center Ring	1
C		Table Leg	4
D		Headless Bolt	4
E		Big Flat Washer	4
F		Big Lock Washer	4
G		Lock Nut	4
H		Bolt	4
I		Small Flat Washer	4
J		Small Lock Washer	4

Assembly Instructions

ATTENTION:

1. **DO NOT** use power tools or over-tighten hardware during assembly.*

*Aluminum is soft metal, so over-tightening may strip threads or break the parts.

2. Please read these instructions carefully before assembling.

3. During assembly, place furniture against soft surfaces to avoid scratching the paint/ metal.

ASSEMBLY STEPS:

1. Place the **TABLETOP (A)** upside down onto a clean and soft, non-abrasive surface.
2. Screw the short side of the **HEADLESS BOLTS (D)** into the 4 holes of the **TABLETOP**.
3. Loosely secure the **LEGS (C)** to the **TABLETOP** using **BIG FLAT WASHERS (E)**, **BIG LOCK WASHERS (F)**, and **LOCK NUTS (G)**. *Do not tighten at this time.
4. Position the **CENTER RING (B)** between the **LEGS** and secure the parts together using **BOLTS (H)**, **SMALL FLAT WASHERS (I)**, and **SMALL LOCK WASHERS (J)**.
5. Tighten all bolts and nuts completely.
6. Turn the table onto its legs.
7. If needed, you may use the adjustable feet to level out the table.

CARE INSTRUCTIONS:

Please **DO NOT** use acid or alkaline washing liquids to clean this product. Harsh cleaners can cause the powder-coated finish to stain and fade. Use a soft towel with mild liquid soap and water to clean the product, and dry with a soft cloth.