

DREAMS

IDEA

Instruction Manual



DREAMS/DEA

NO.CH0052-ARMCHAIR

ABOUT US

DREAMSIDEA IS A ONE-STOP HOME
FURNISHING AND SERVICE COMPANY BASED IN USA.

WE ARE DEDICATED TO BRINGING YOUR DREAM HOME TO LIFE.

OUR SERVICES COVER FROM DESIGN, PRODUCTION,
DIRECT SELL, STORAGE, AND TRANSPORTATION.

IF REALITY IS THE NEAR SHORE
AND IDEALISM THE FAR SHORE,

DREAMSIDEA
AS THE FERRY BETWEEN THEM,
EAGER TO ACCOMPANY YOU ON A JOURNEY
TO YOUR IDEAL HOME.

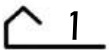

ITEM NO.CH0052-ARMCHAIR

WARRANTY

We strive to offer high quality product and we also try our best to satisfy each customer that order from us, no matter on products or services as needed. Each customer receives a record of their order, such as the order number or item receipt. For any items that are out of warranty period, you may still be able to purchase the replacement parts from our company if they are available.

Are you having difficulty
with assembly? Missing parts?
Please contact us : info@firstopintl.com
Tel:(562)-781-3327

send an email with your order No. to us
For return, please check the return policy with
the retailer or platforms you bought from.
Appreciate your purchasing from us.
Pop up your life by our furniture !

MAINTENANCE AND WARNING

Please read the manual thoroughly
before you start installing.

Please keep the product away from
sharp object.

Packaging and small parts may have
chocking hazard, please keep them away
from children and pets.

Please clean the product according to each
clean code, check the product description
for more information.

Please keep the product away
from fire.

If you have any other questions, please
contact us, we will be glad to help you out.

If the product is placed under direct
sunlight, the pattern or color might fade
away overtime.

Check the product periodically to make
sure everything is secured and tightened.

Always use proper tools for installation.

Do not jump on the product.



Around 25 min

PRDOUCT DESCRIPTION

Upholstered in premium cotton flannel, delivering an ultra-soft, silky feel that mimics real fur.

Seat cushion blends spring coils, elastic foam, and synthetic fibers for balanced comfort and support.

Ergonomically designed backrest offers excellent lumbar support, ideal for extended sitting.

Durable construction ensures long-lasting use while maintaining a cozy, inviting appearance.

Perfect for living rooms, bedrooms, or home offices, combining luxury and functionality effortlessly.

Dream



House



EXPLODED VIEW

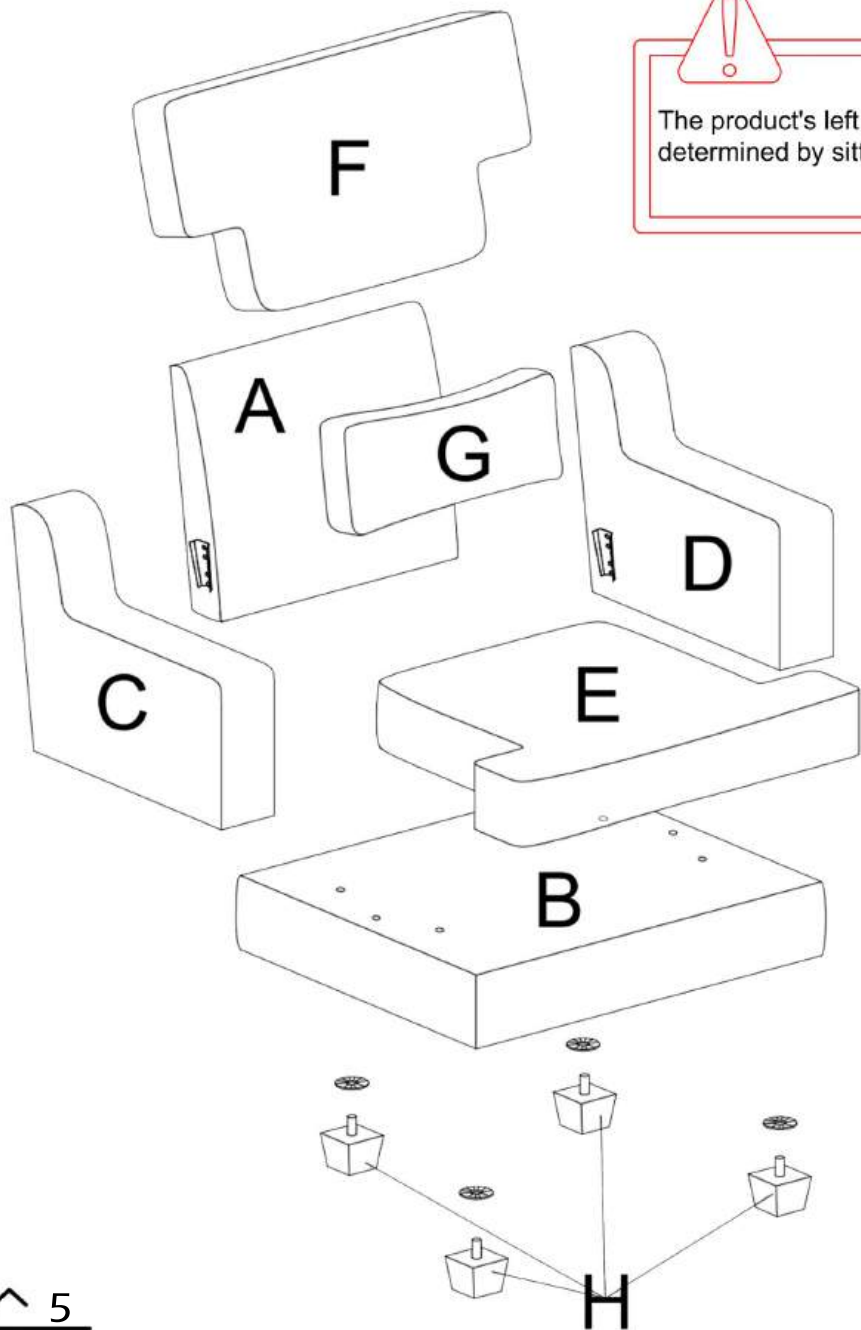

The product's left and right are determined by sitting posture

PARTS

A*1



Backrest frame

B*1

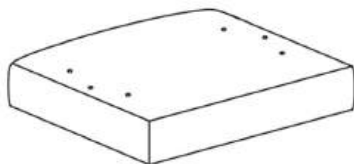

Seat frame

C*1



Right armrest

D*1



Left armrest

E*1



Seat cushion

F*1

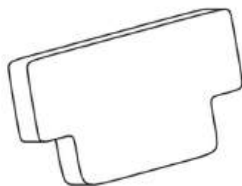

Back cushion

G*1



Pillow

H*4



Legs

HARDWARE

TOOL LIST

NOTE: Designated with (★) We provide additional spare parts in the hardware package

①*6



★ Bolt

②*6



★ Spring washer

③*6



★ Flat washer

④*6



★ Nut

⑤*1

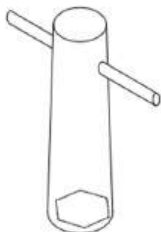

Hexagon socket wrench

⑥*4



Plastic washer

Please make sure all hardware&packing material fitting the list. Especially some small accessories may be missing during transportation. Please contact us if you have any question.

step 1 ---Cut the plastic air compression bags

Cut the Cushions (E) and (F) from the air compression bags as shown. It might take **48** hours to be fully recovered. You may gently slap on them to speed up the process.

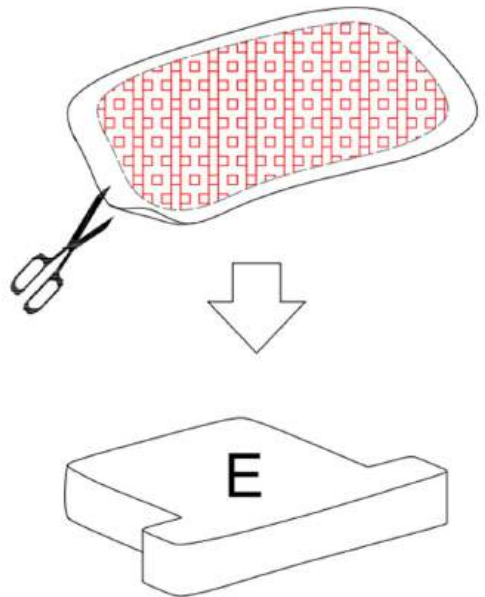
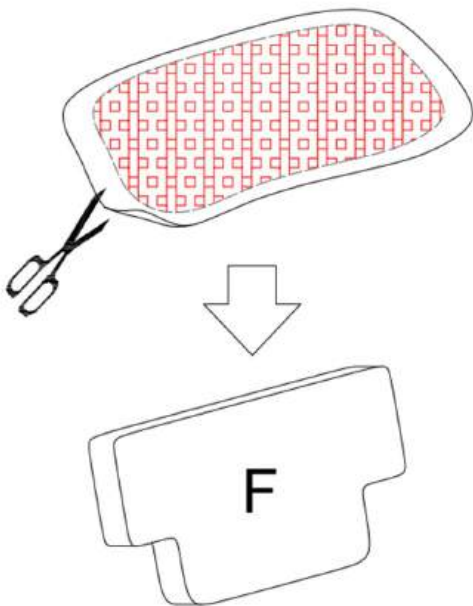
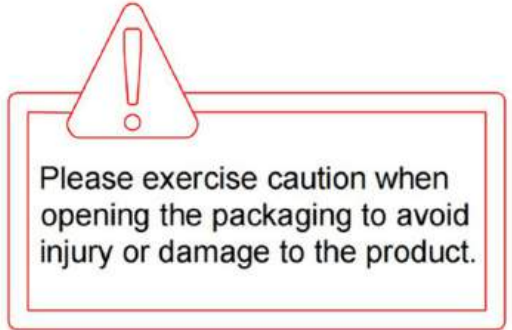

step 2 ---Pre-install the bolts.

Use hand to twist the bolts (1) into the designated holes on both armrests as shown.

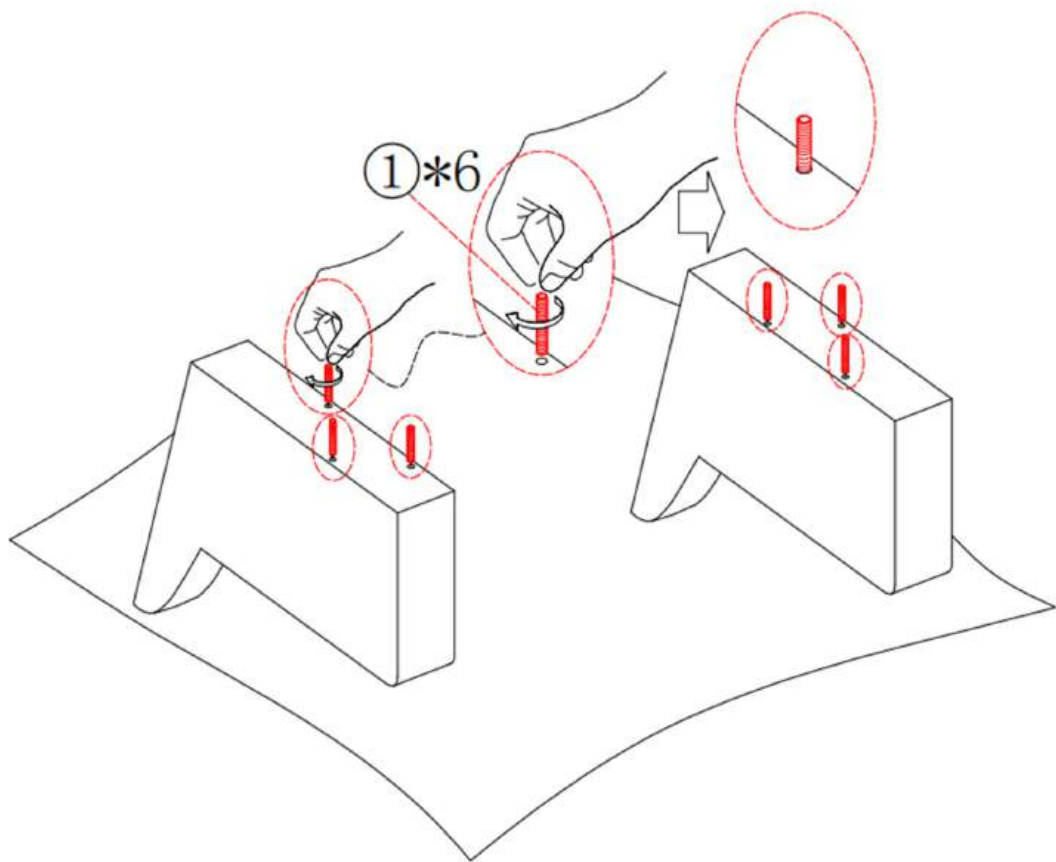

step 3 ---Install the Seat frame (B).

Place the seat frame (B) on to the armrests as shown, make sure the designated bolt holes on the seat frame are correctly aligned with the bolts on the armrests.

According to the diagram, place the flat washer(3), spring washer(2), and nut (4) in order on the bolts, then tighten them with the hexagon socket (5) wrench provided.

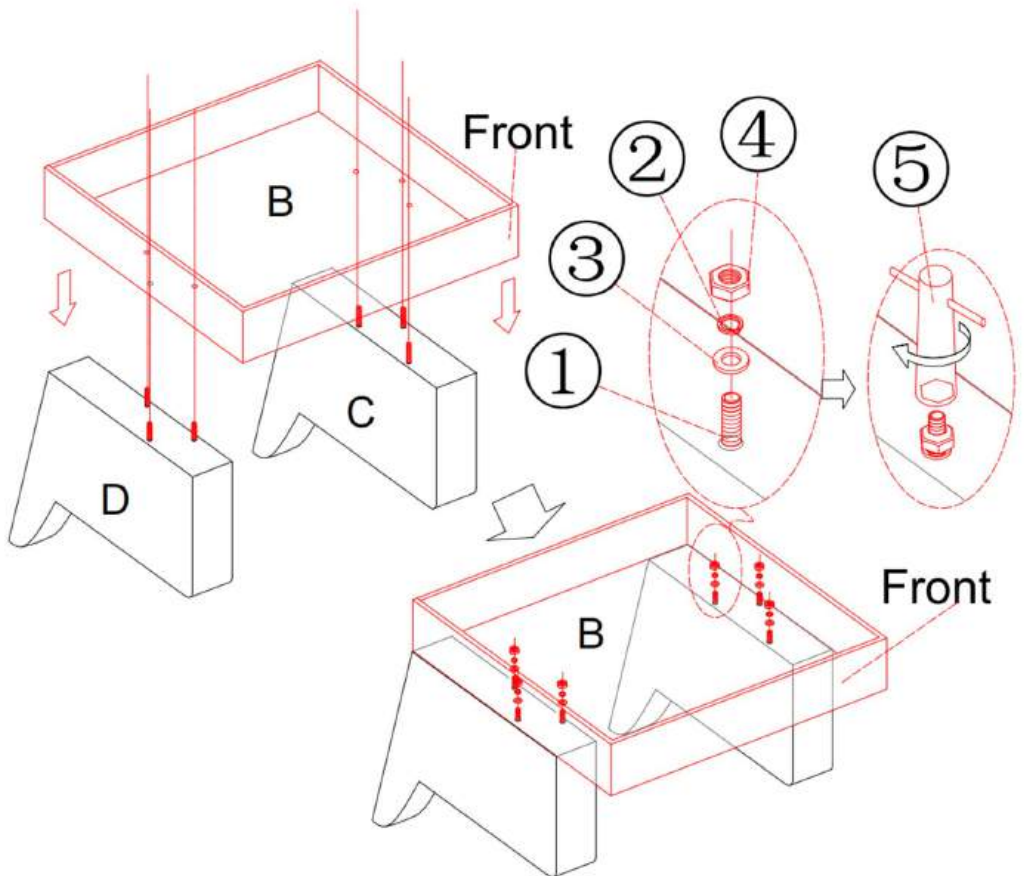

step 4 ---Twist the sofa legs (H)

Please one plastic washer (6) on it,Then align all four sofa legs (H) with the predrilled holes underneath the sofa frame, tighten them clockwise until they are fully tightened.

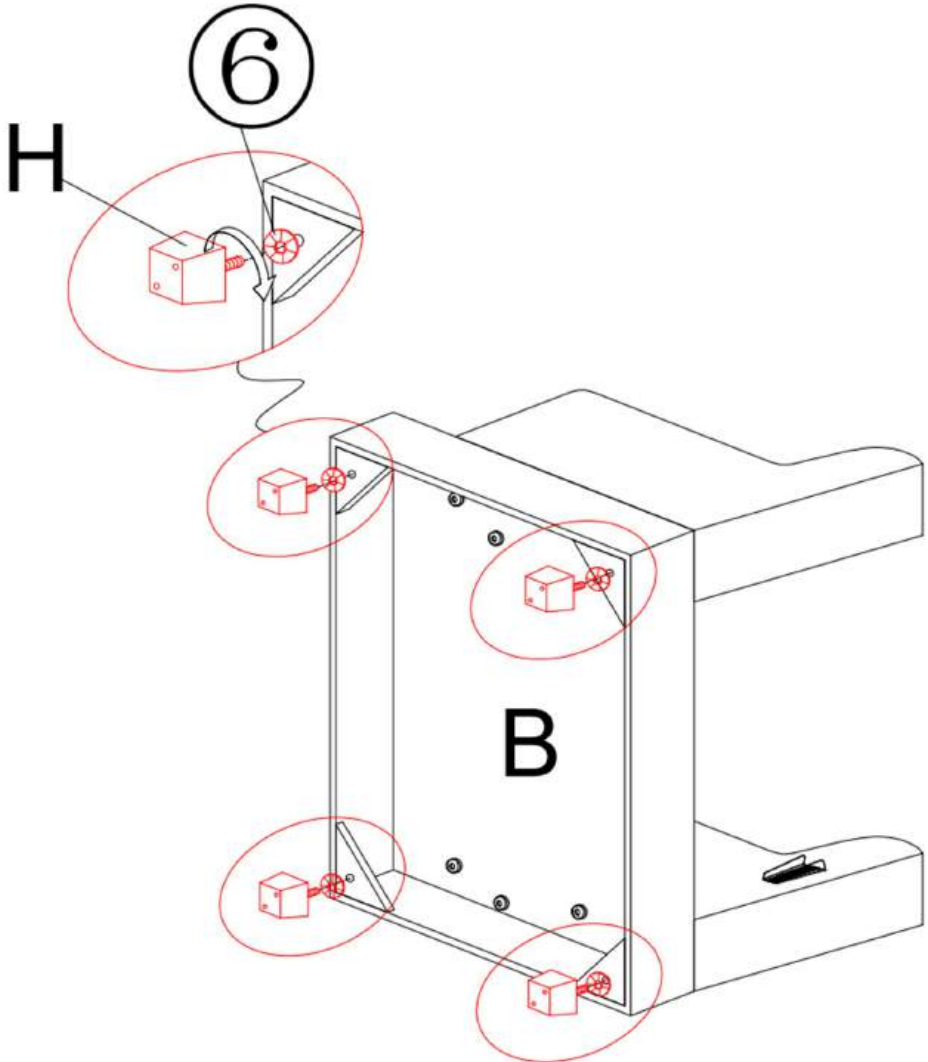

step 5 ---Install the backrest (A)

Place the sofa on its feet, and align the connectors on its backrest with the slots on the armrest as shown. Make sure both connectors are correctly aligned before pushing down.

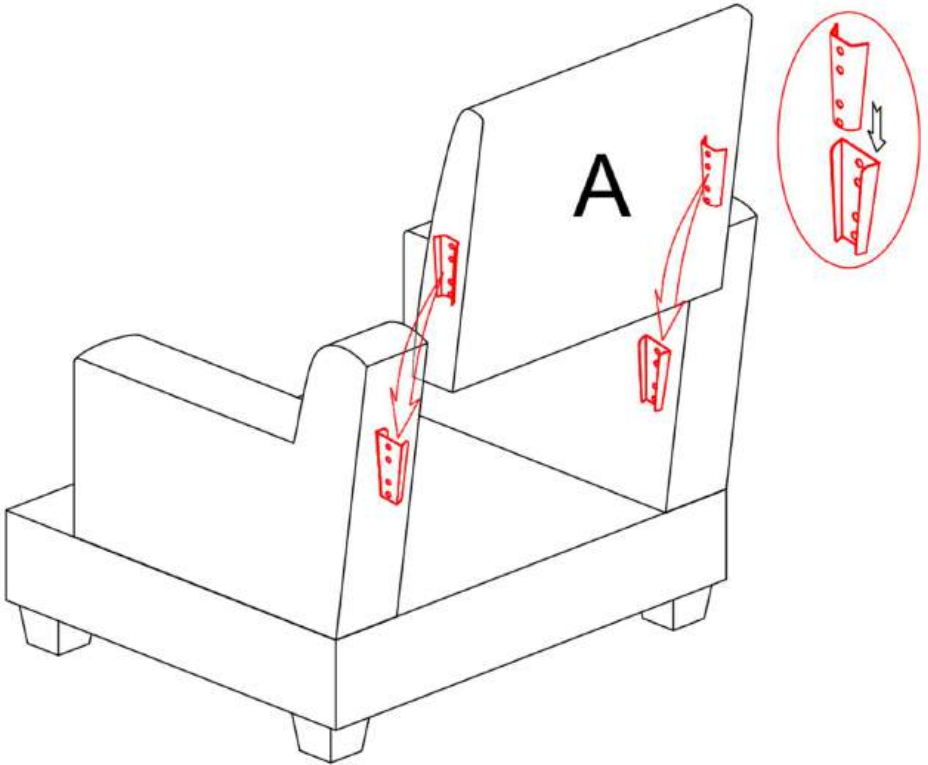

step 6 ---Place the Seat cushion (E) and Back cushion (F)

Place the seat cushion (E) on the seat frame, and the back cushion (F) on the back frame.

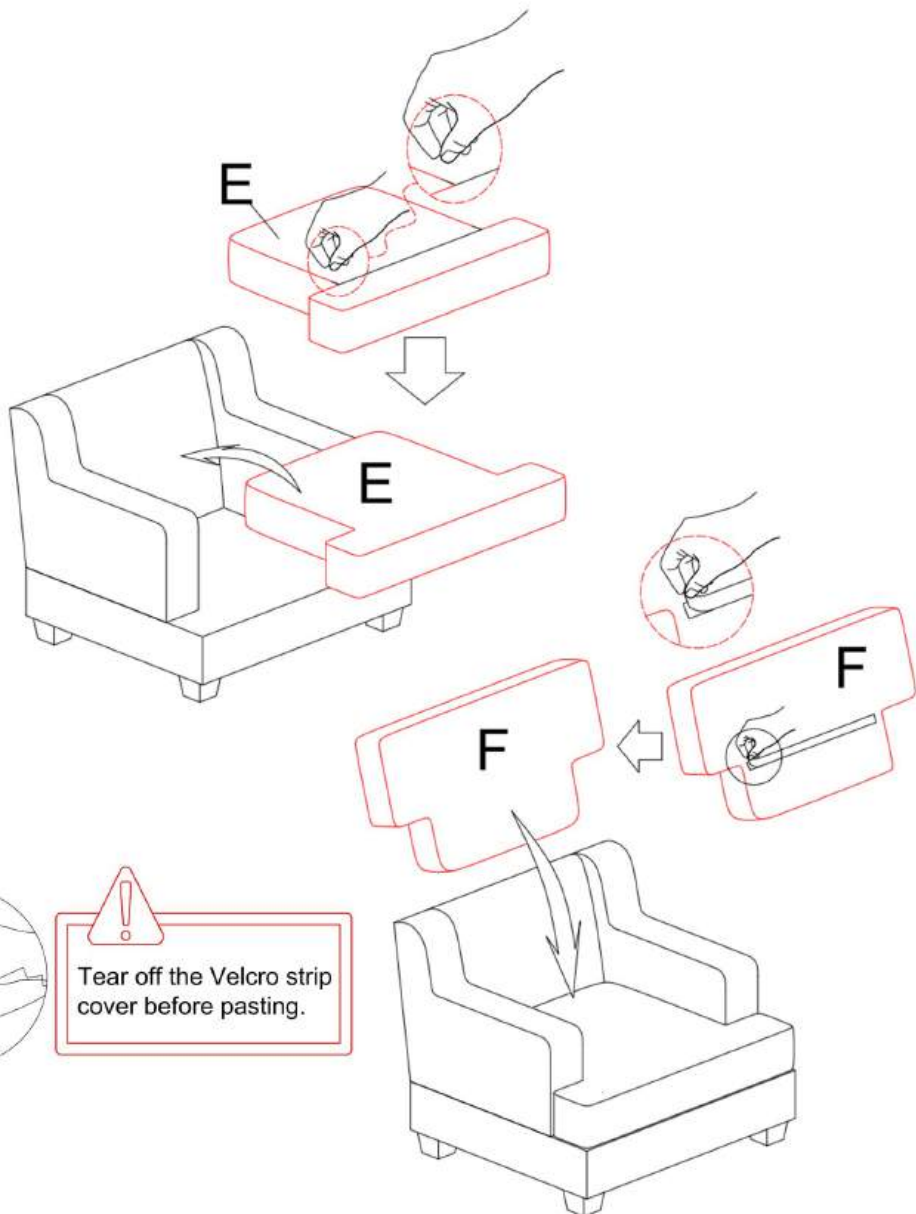

step 7 ---Place the Pillow (G)

Place the pillow (G) on the back cushion.

Congradulations! You have finished the assembly, thank you again for choosing our product! Please enjoy!

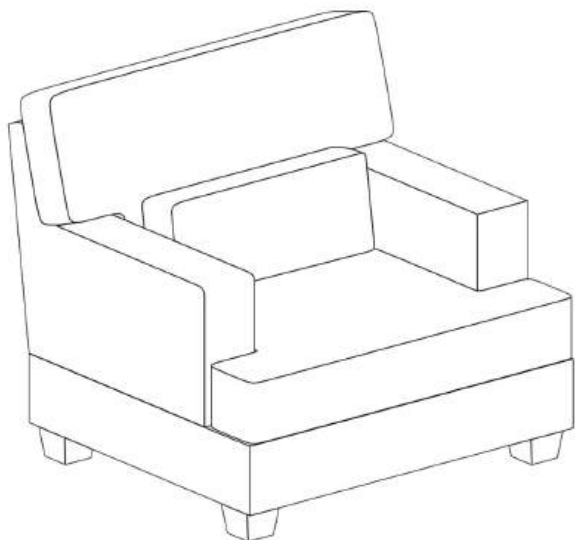
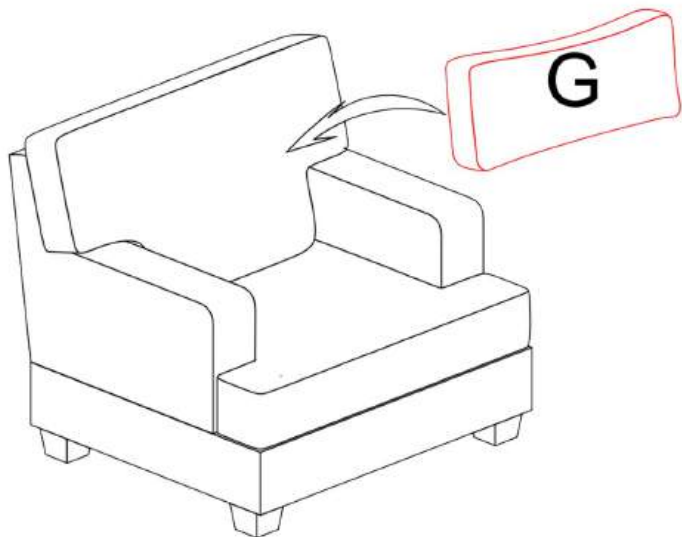



ASSEMBLY INSTRUCTIONS

Tel.(562)-781-3327

Please contact us:info@firstopintl.com

<https://www.dreamsidea.com>