

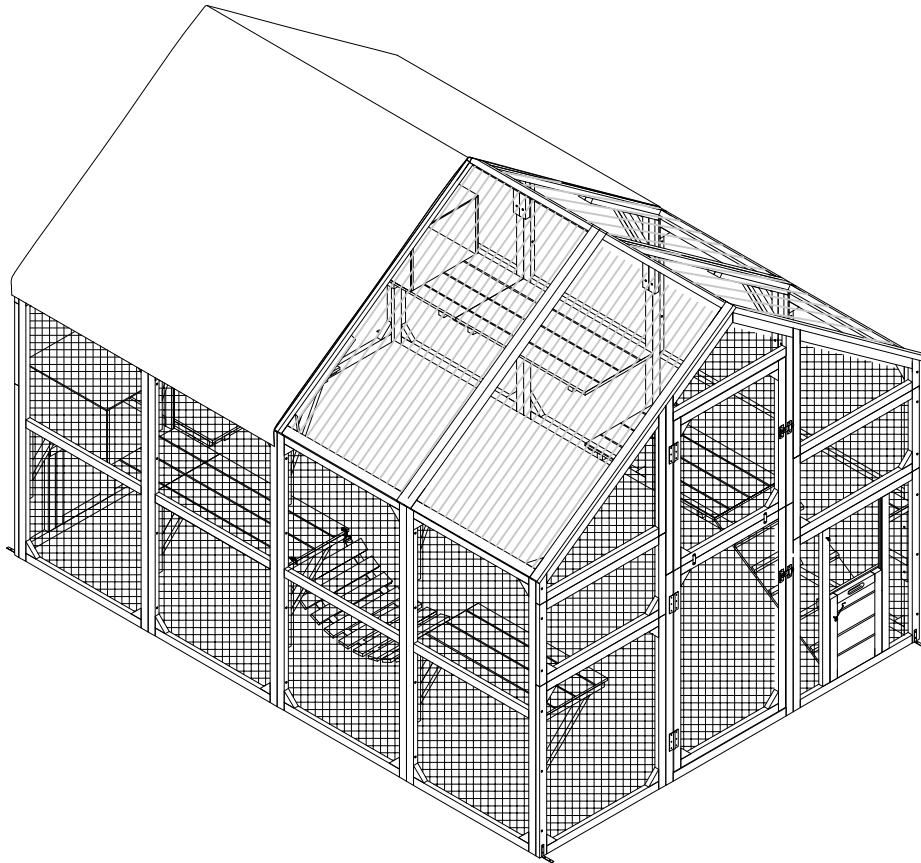

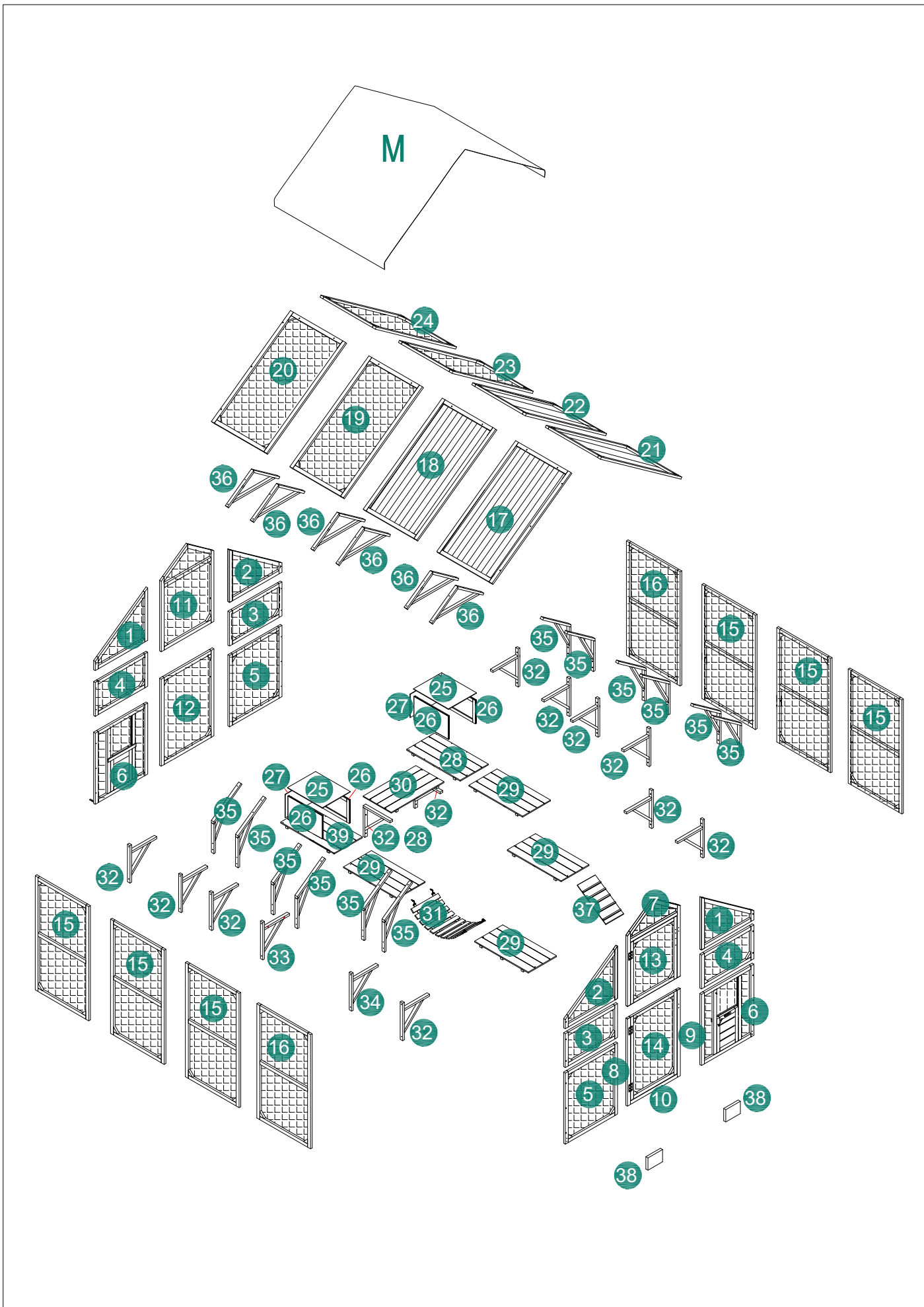

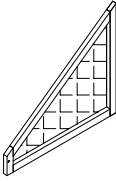

Cat House

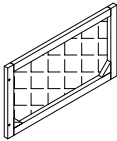
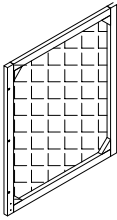
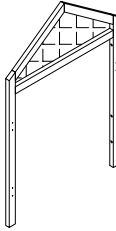
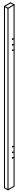

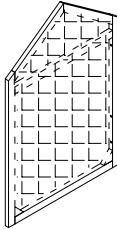
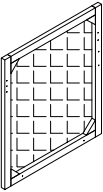
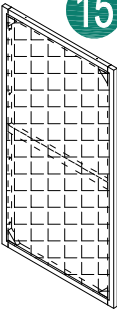
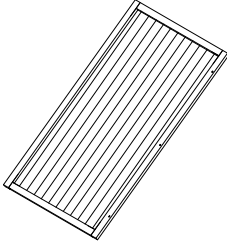
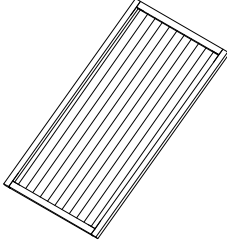
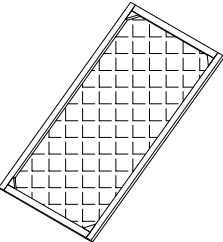
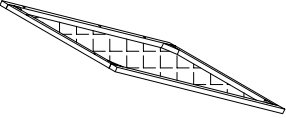
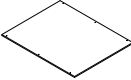
ASSEMBLY INSTRUCTIONS

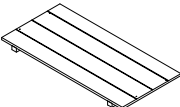
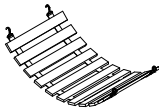



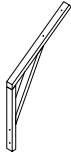
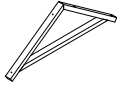

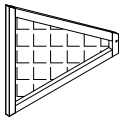
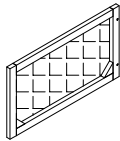

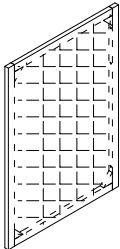
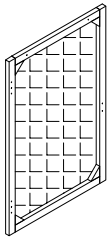
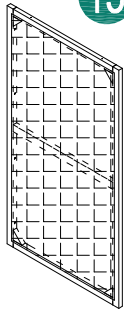
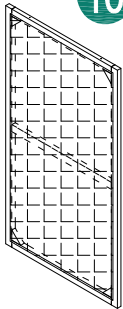
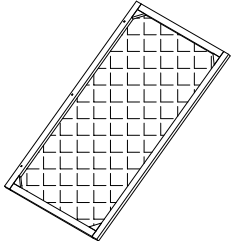
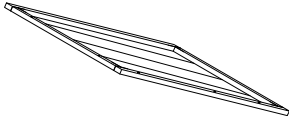
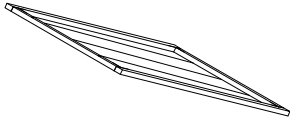
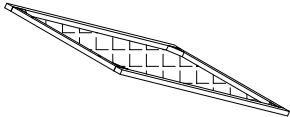
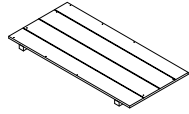

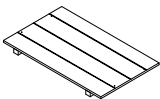



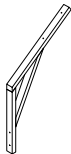
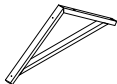
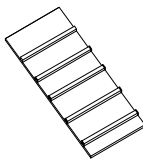

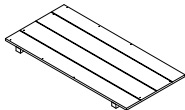

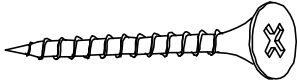

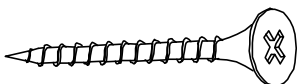
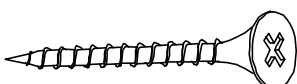

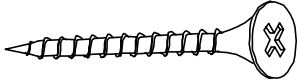
<p>2 × 2</p> 	<p>3 × 2</p> 	<p>5 × 2</p> 	<p>7 × 1</p> 
<p>8 × 1</p> 	<p>9 × 1</p> 	<p>10 × 1</p> 	<p>11 × 1</p> 
<p>13 × 1</p> 	<p>15 × 4</p> 	<p>17 × 1</p> 	<p>18 × 1</p> 
<p>19 × 1</p> 	<p>24 × 1</p> 	<p>25 × 2</p> 	<p>26 × 4</p> 
<p>27 × 2</p> 	<p>29 × 4</p> 	<p>31 × 1</p> 	<p>32 × 6</p> 

<p>35 × 2</p> 	<p>36 × 4</p> 		
---	---	--	--

<p>1 × 2</p> 	<p>4 × 2</p> 	<p>6 × 2</p> 	<p>12 × 1</p> 
<p>14 × 1</p> 	<p>15 × 2</p> 	<p>16 × 2</p> 	<p>20 × 1</p> 
<p>21 × 1</p> 	<p>22 × 1</p> 	<p>23 × 1</p> 	<p>28 × 1</p> 

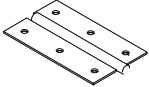
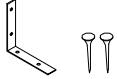
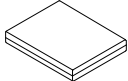
<p>30 × 1</p> 	<p>32 × 6</p> 	<p>33 × 1</p> 	<p>34 × 1</p> 
<p>35 × 10</p> 	<p>36 × 2</p> 	<p>37 × 1</p> 	<p>38 × 2</p> 
<p>39 × 1</p> 			

A		M3.5x60mm	16
B		M3.5x50mm	82
C		M3.5x35mm	148
D		M3.5x20mm	32

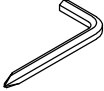
E		M3.5x16mm	88
F		M3.5x12mm	8
G			14
H			2
I			2
J			2
K			3
L			4
M		2600mm	1
N			4
O			4
P			4
Q			1

STEP1

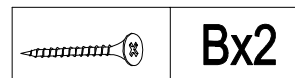
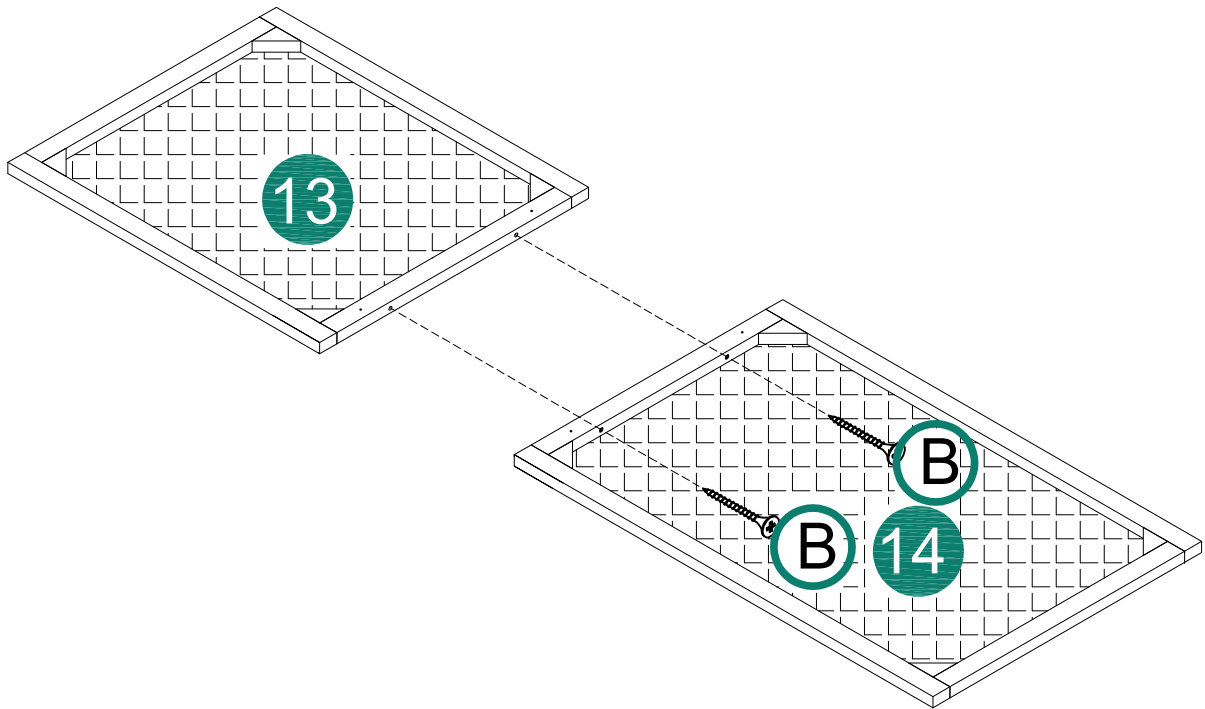

STEP2

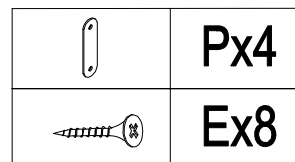
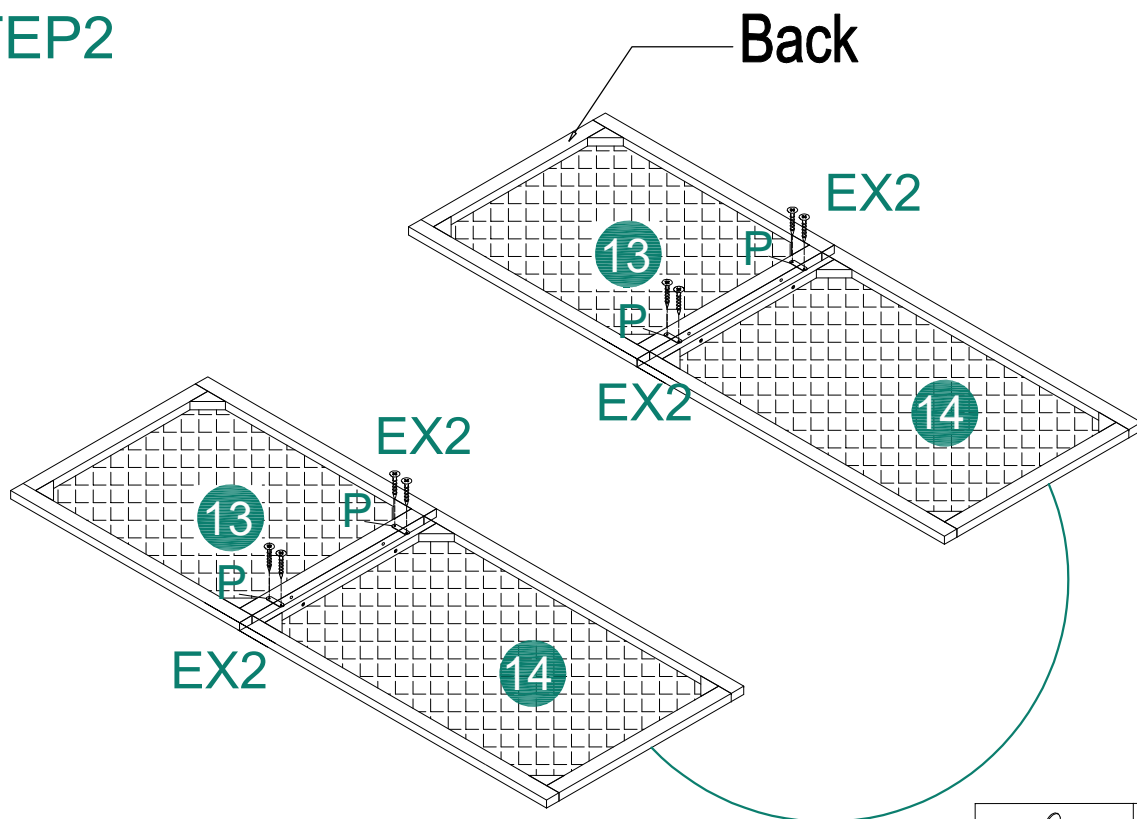

STEP3

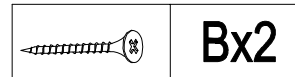
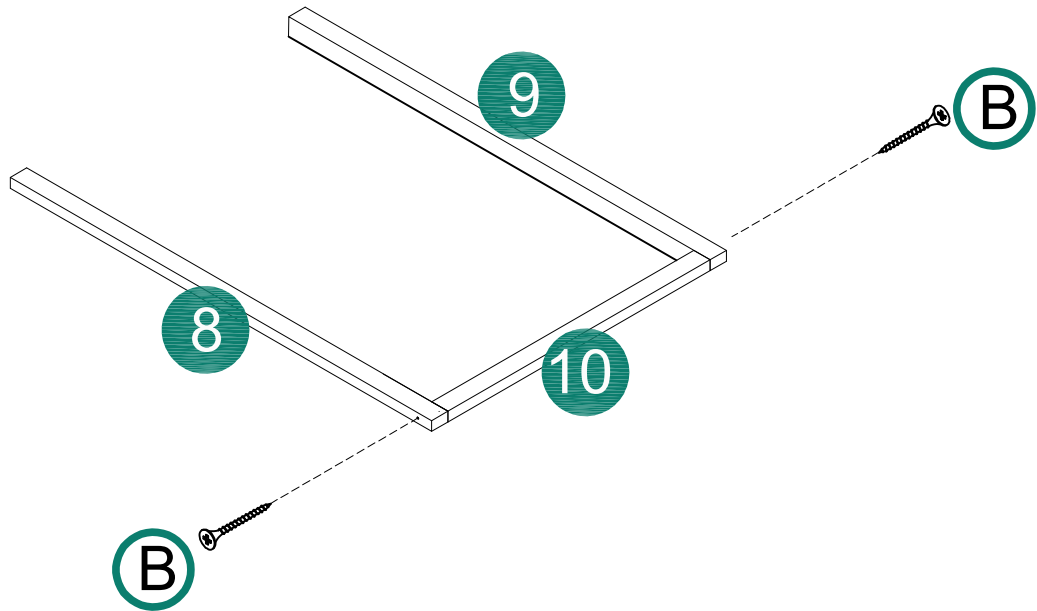

STEP4

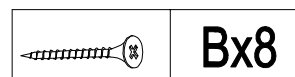
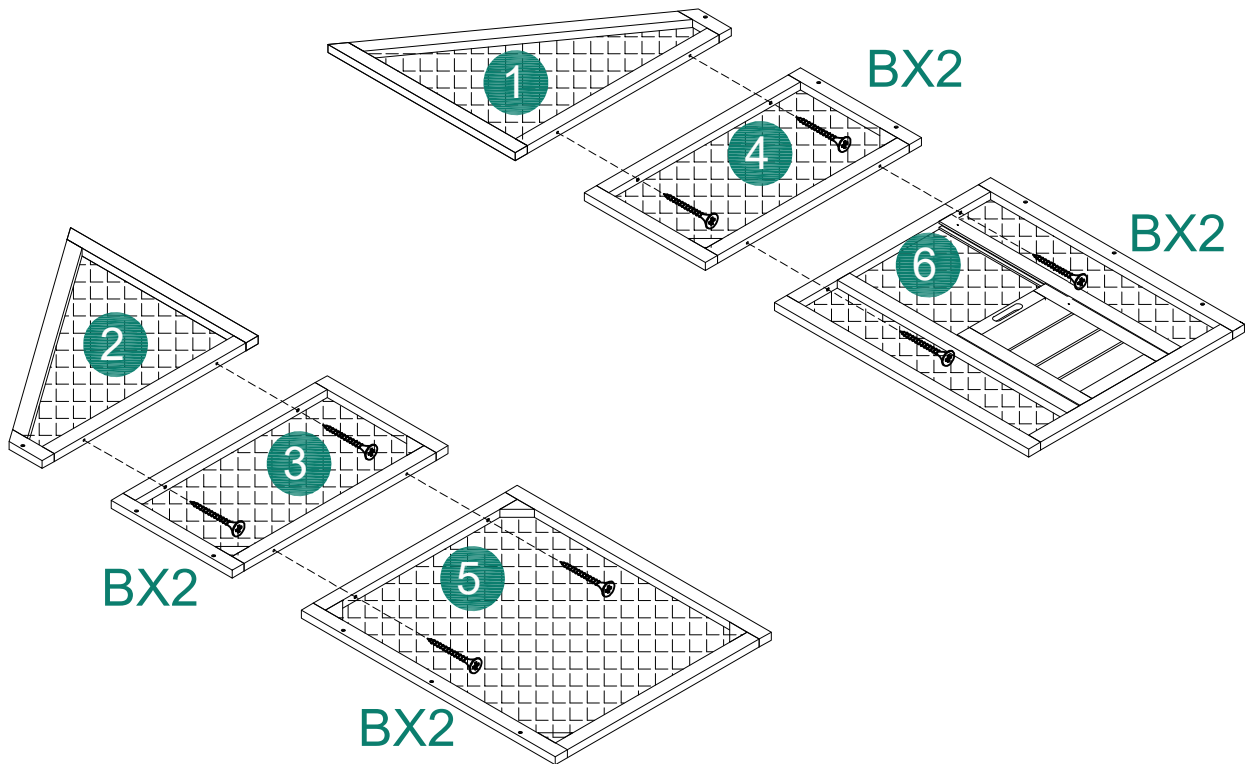

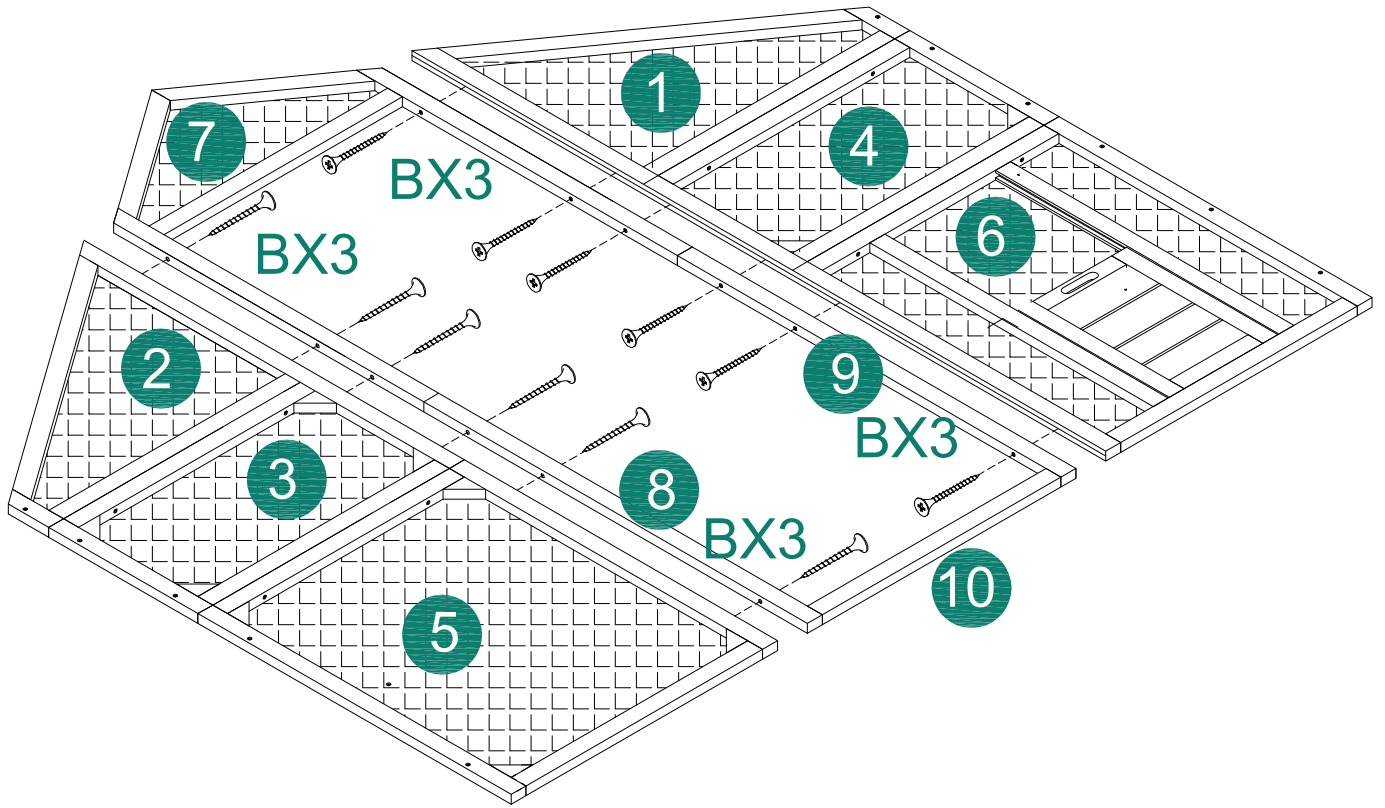

STEP5

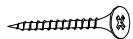

	Bx12
---	------

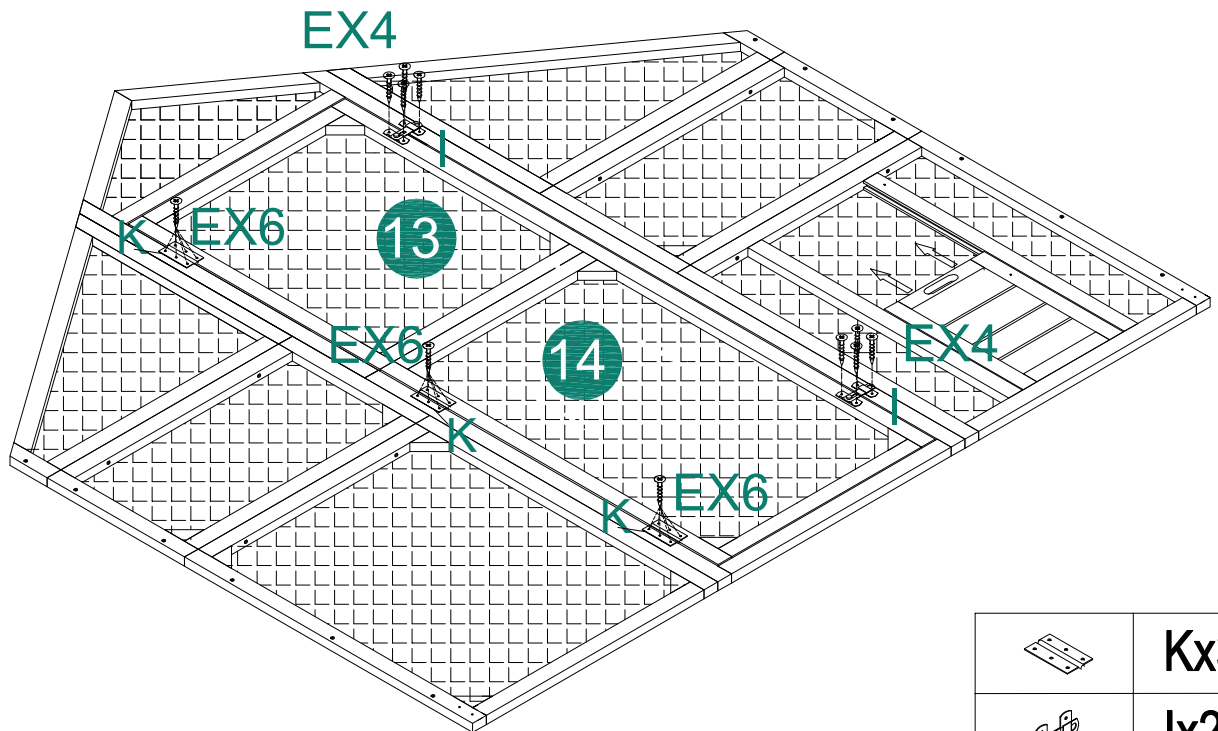
STEP6

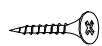

	Kx3
	Ix2
	Ex26

STEP7

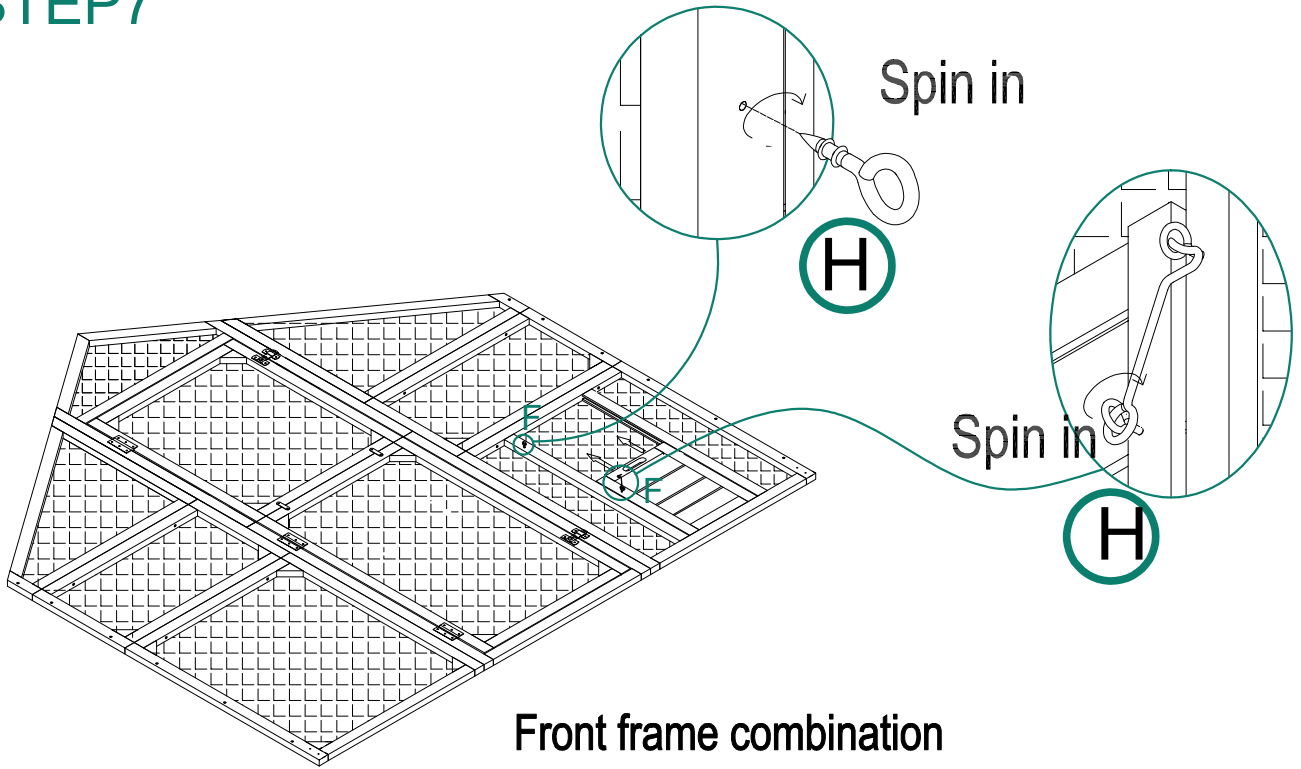

	Hx1
---	-----

STEP8

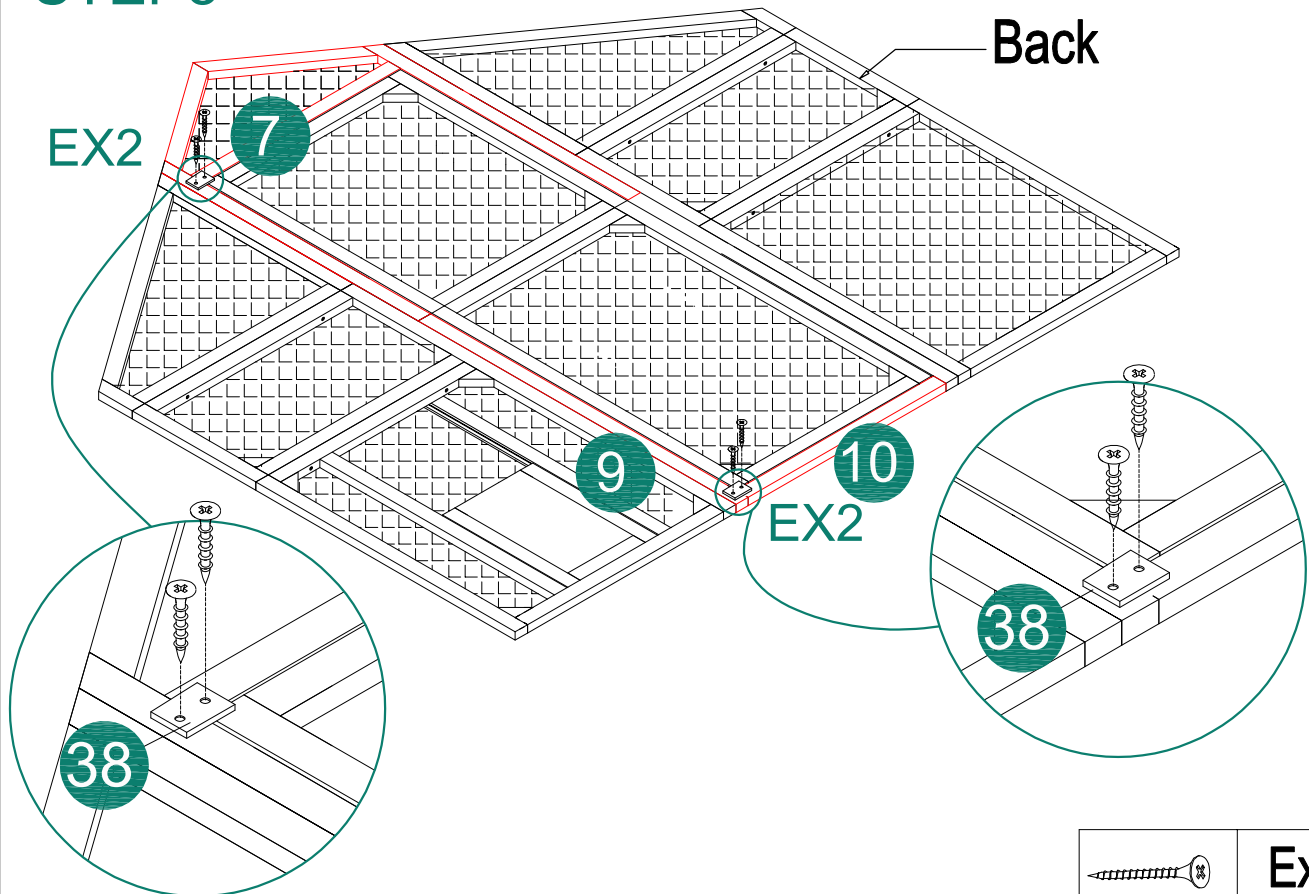

	Ex4
---	-----

STEP9

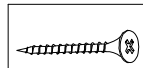
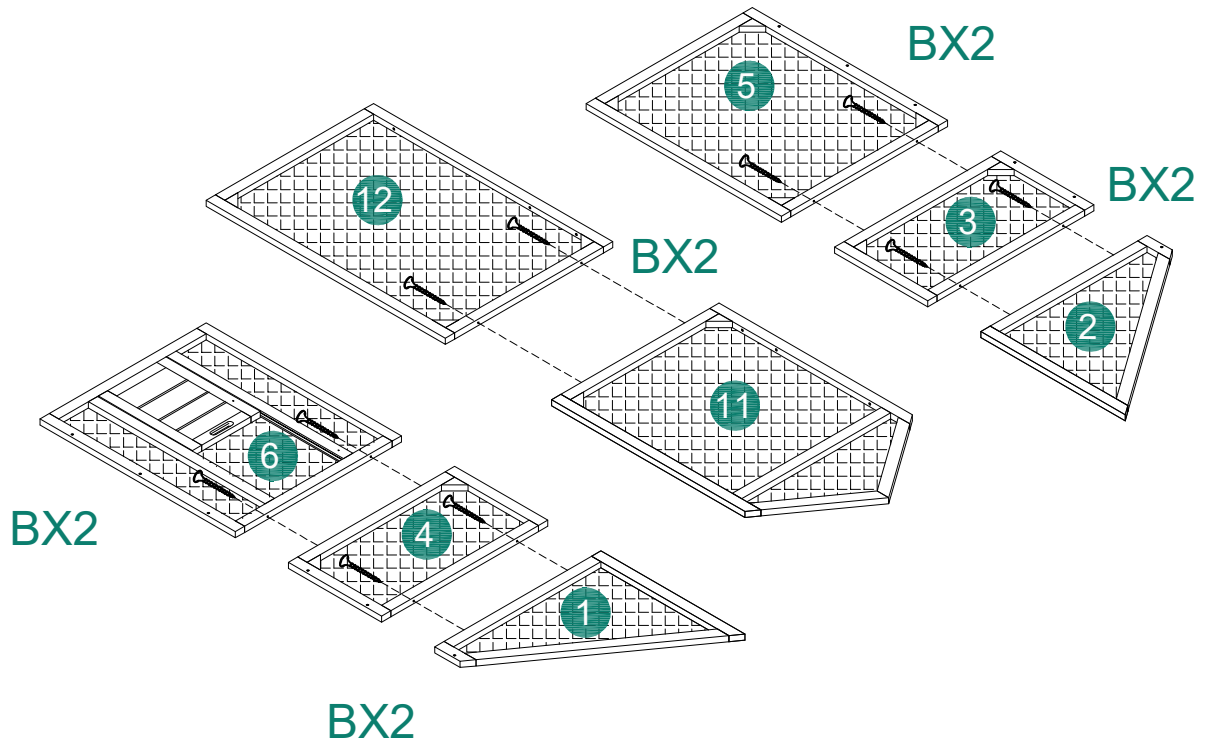

Bx10

STEP10

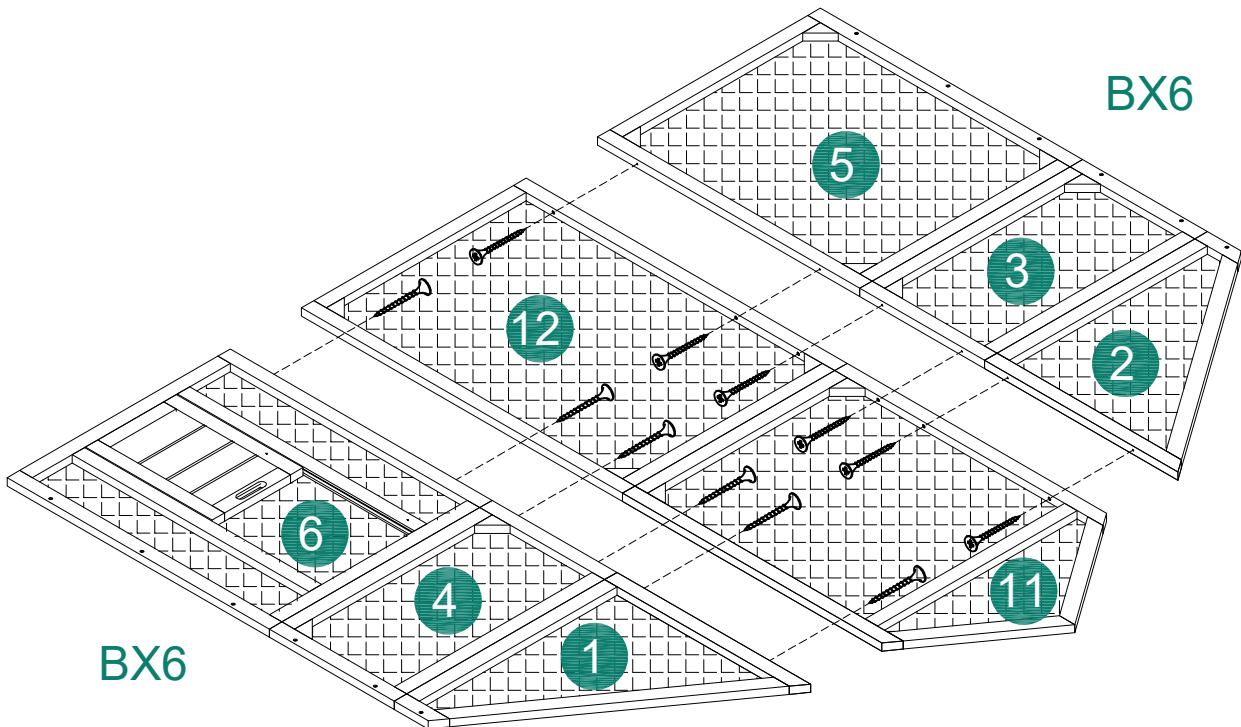

Back frame combination

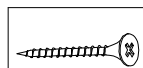

Bx12

STEP 11

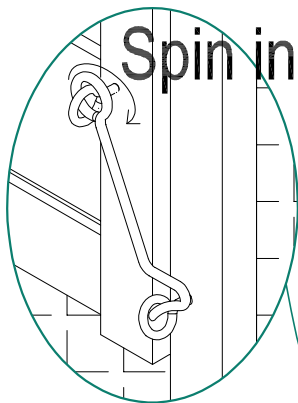

H

Back frame combination

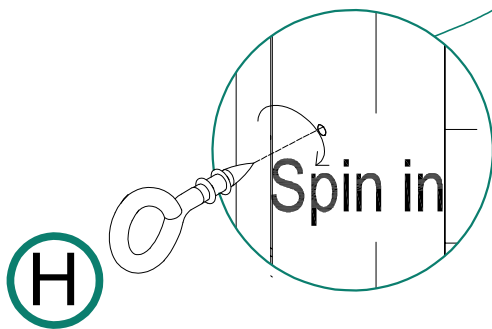
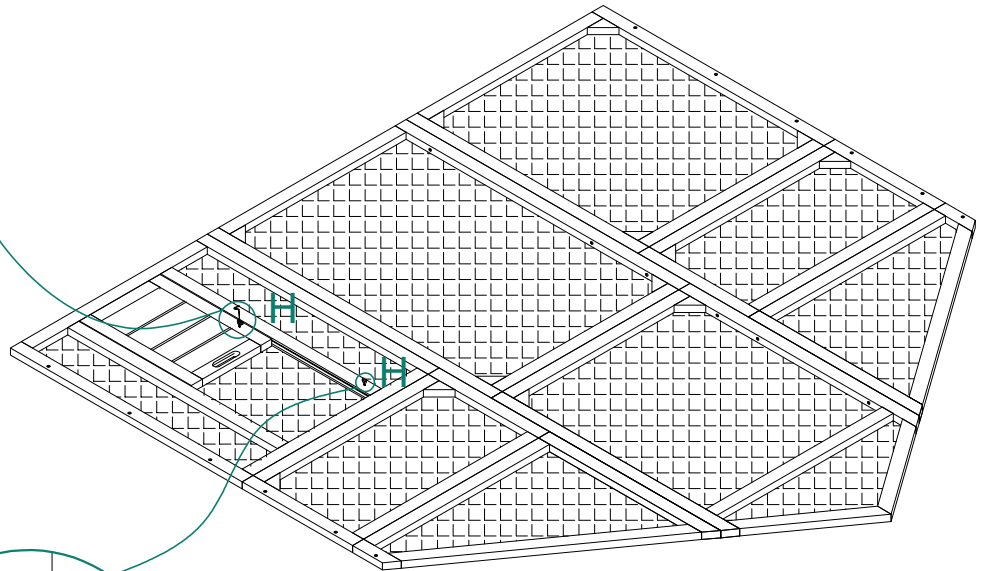

H

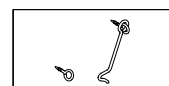

Hx1

STEP 12

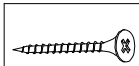
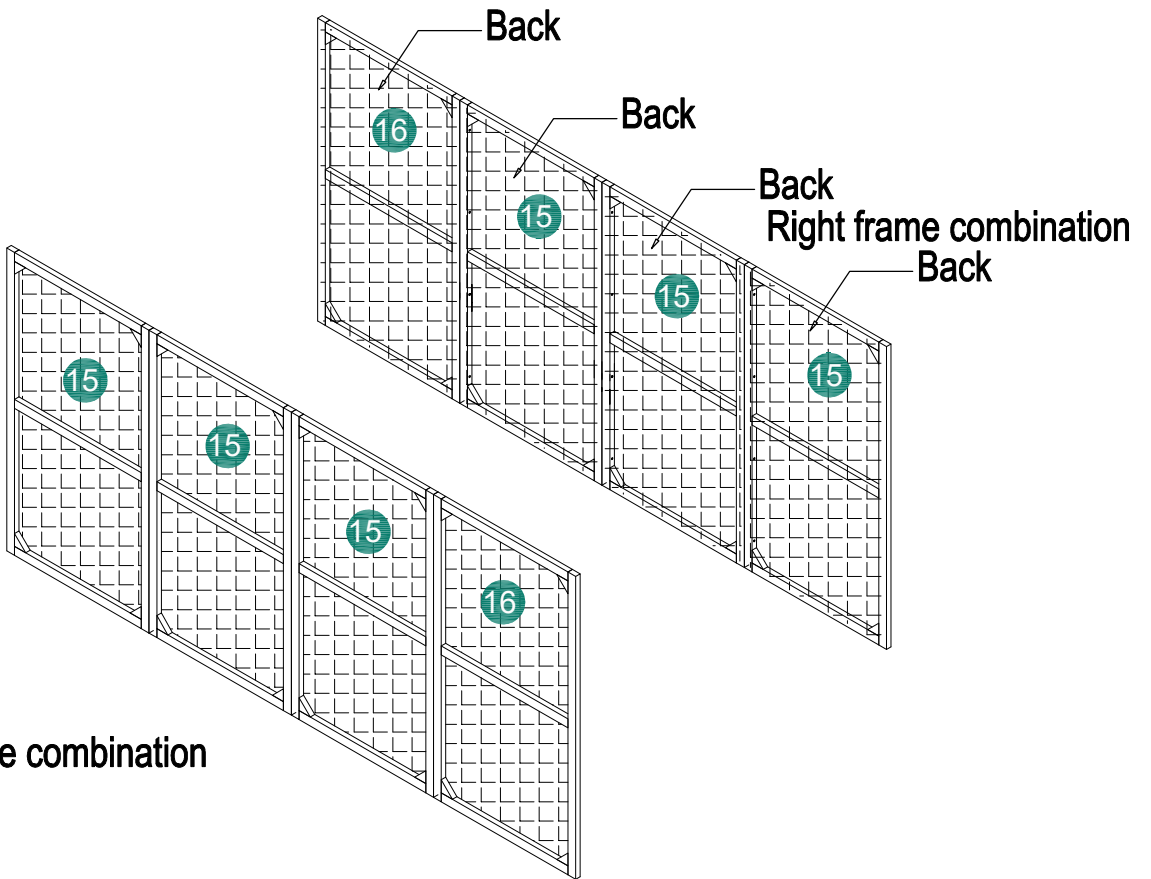
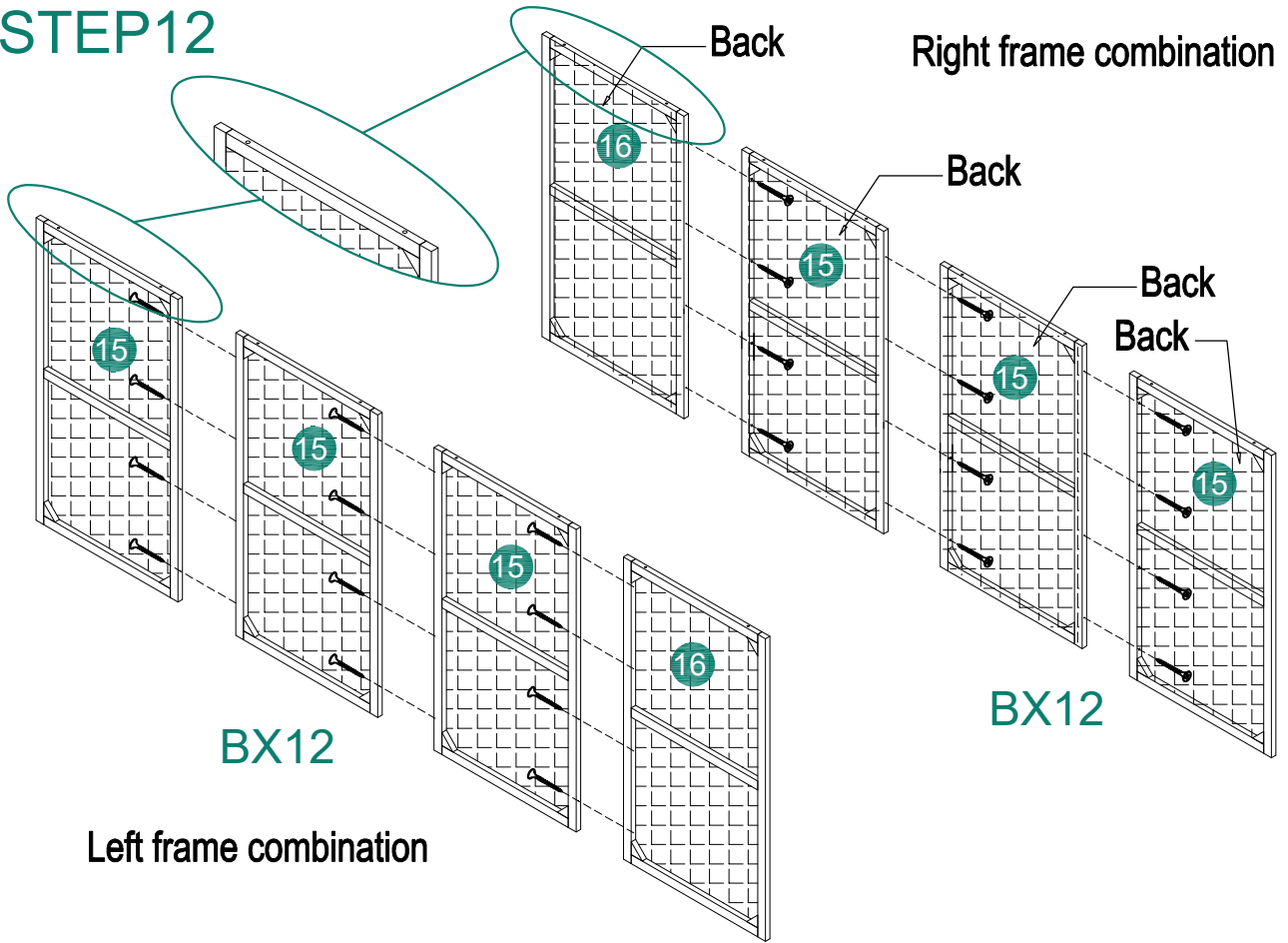

Bx24

STEP 13

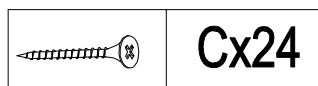
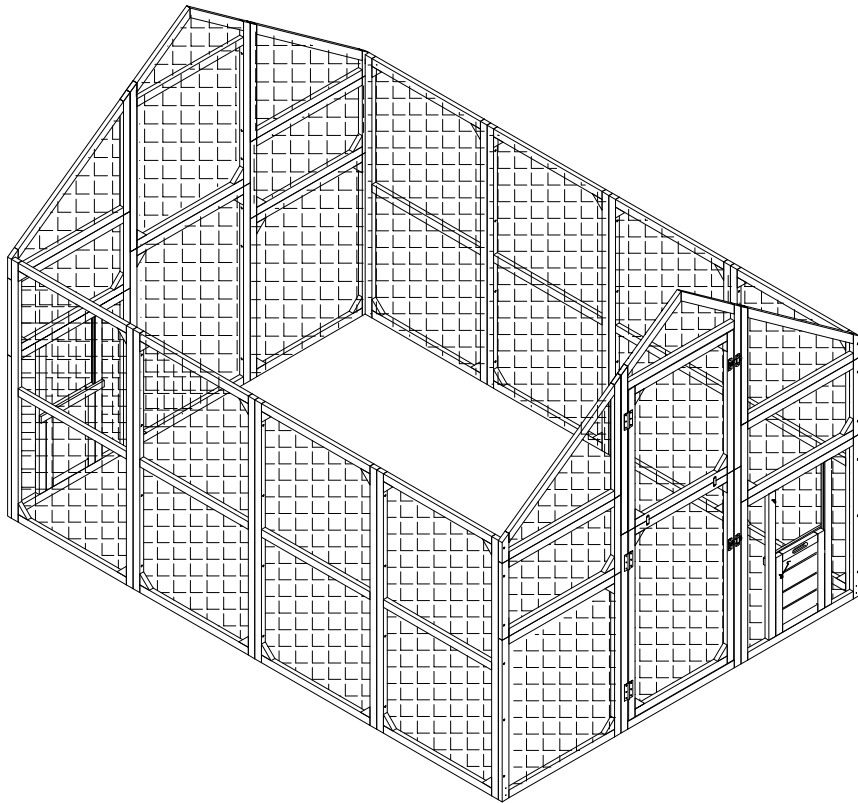
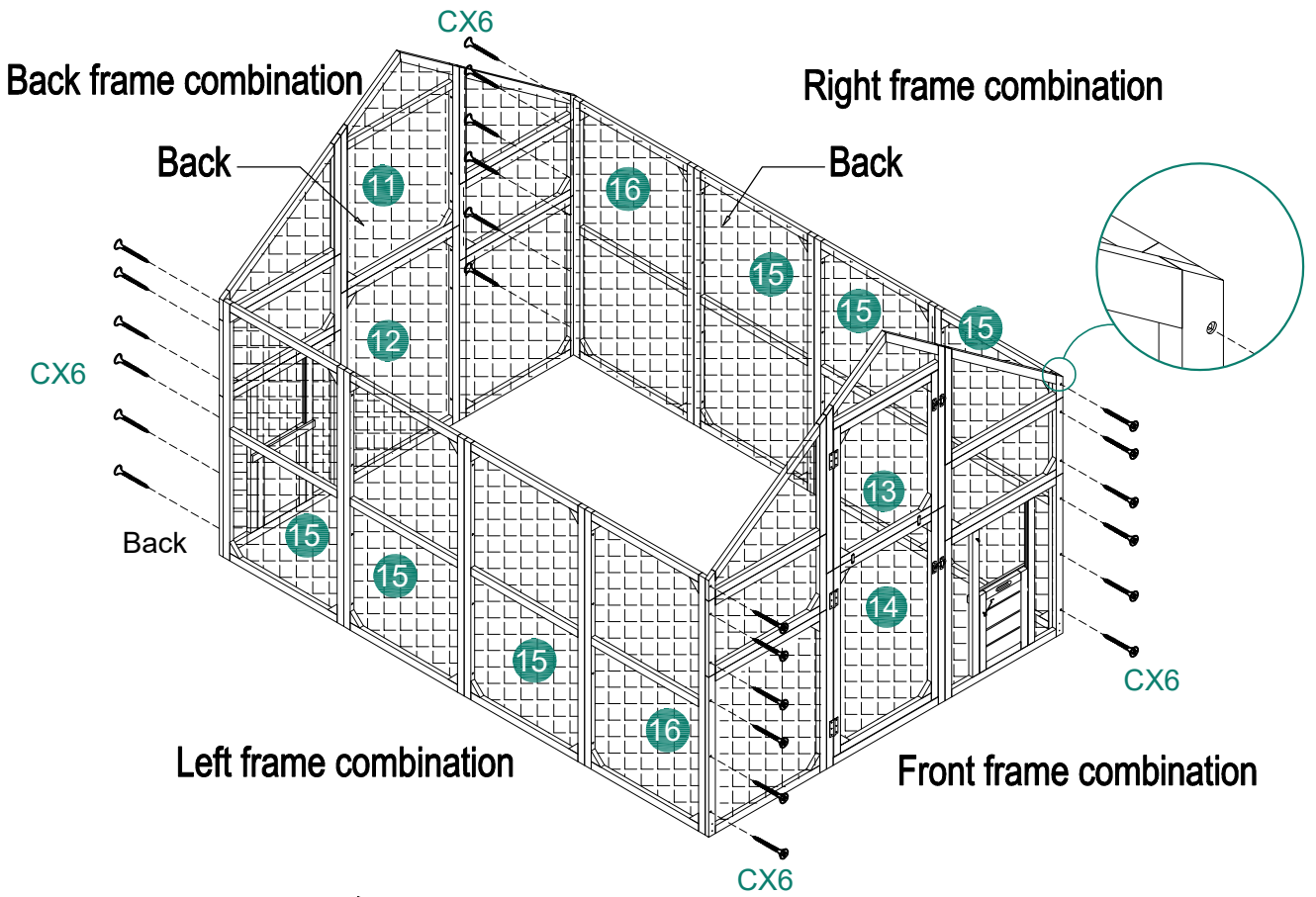

STEP14

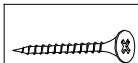
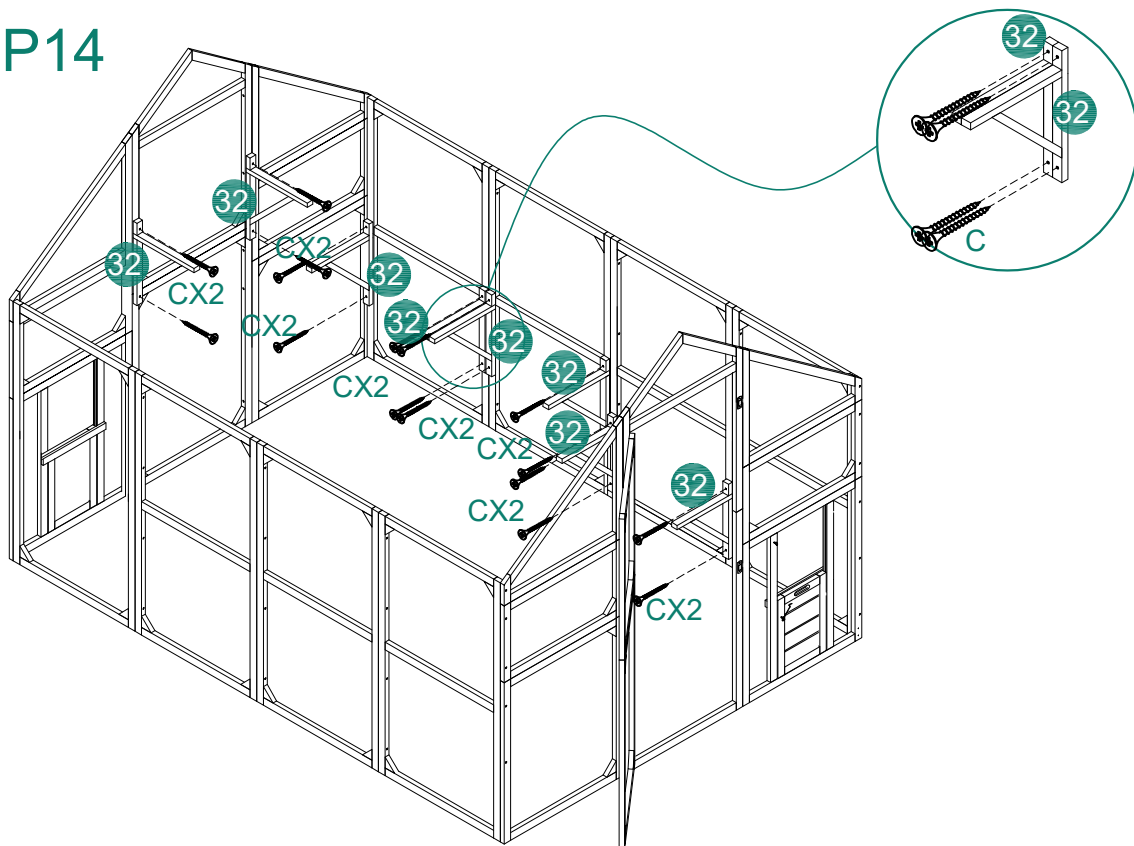

Cx16

STEP15

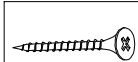
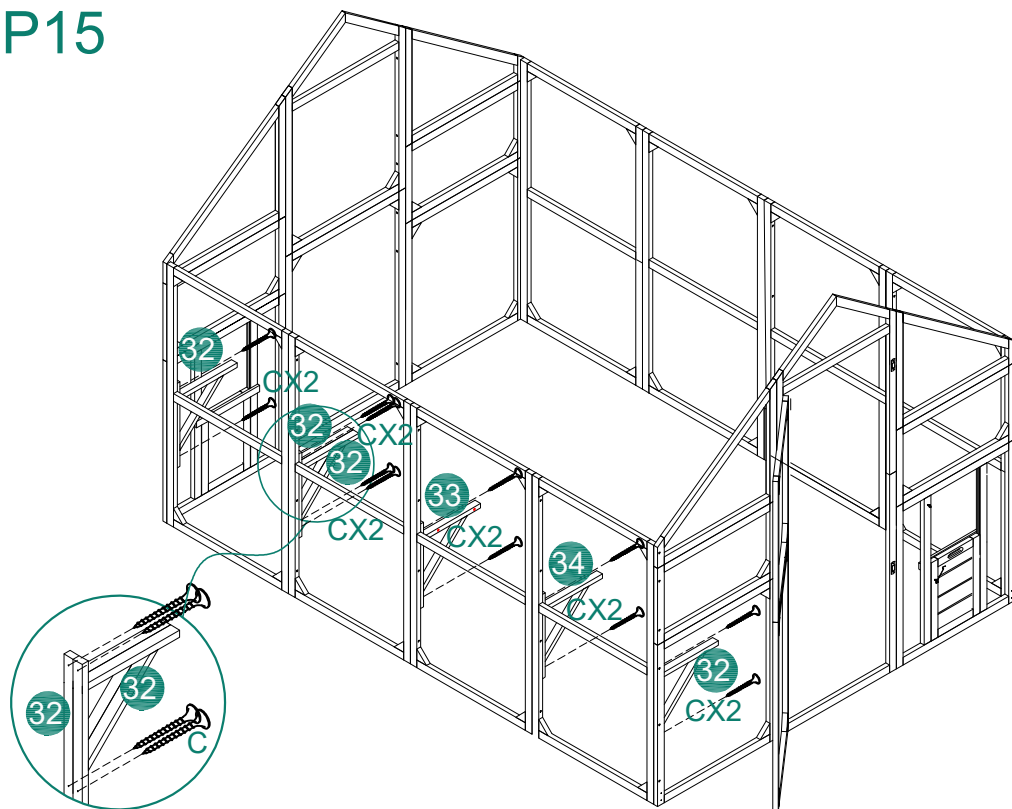

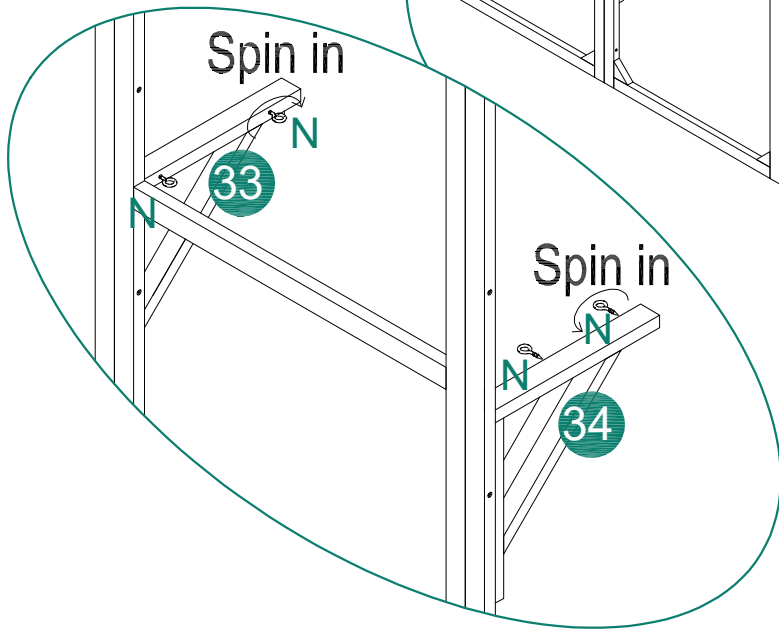
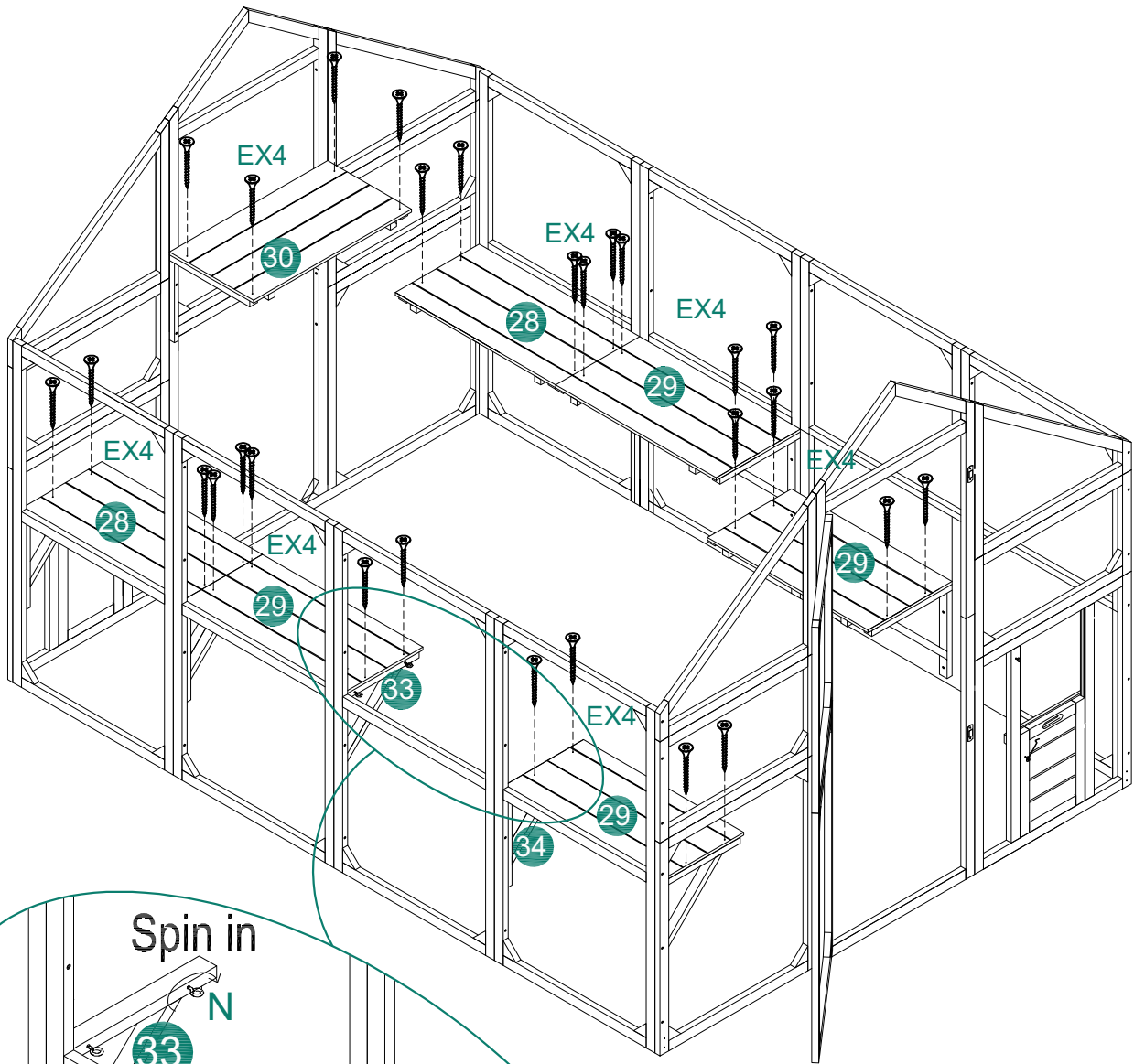

Cx12

STEP 16

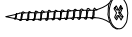

The opposite side is interchangeable mounting

	Ex28
	Nx4

STEP17

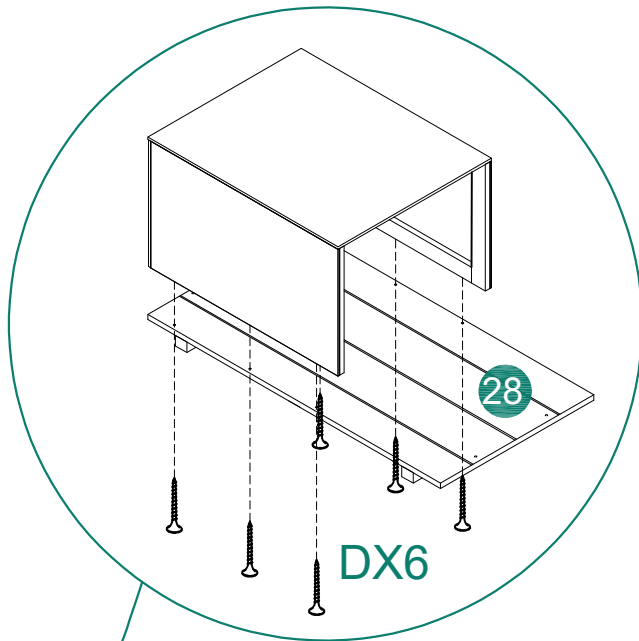
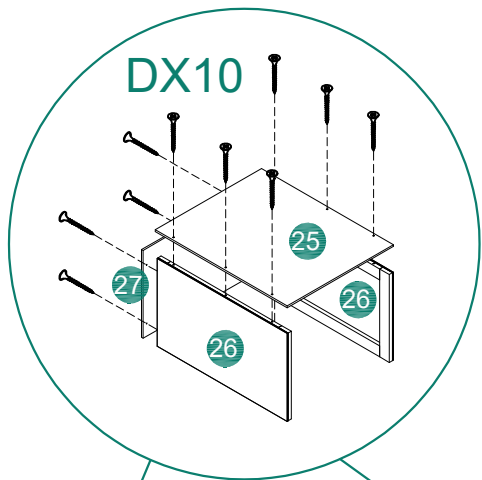

X2

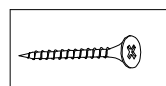
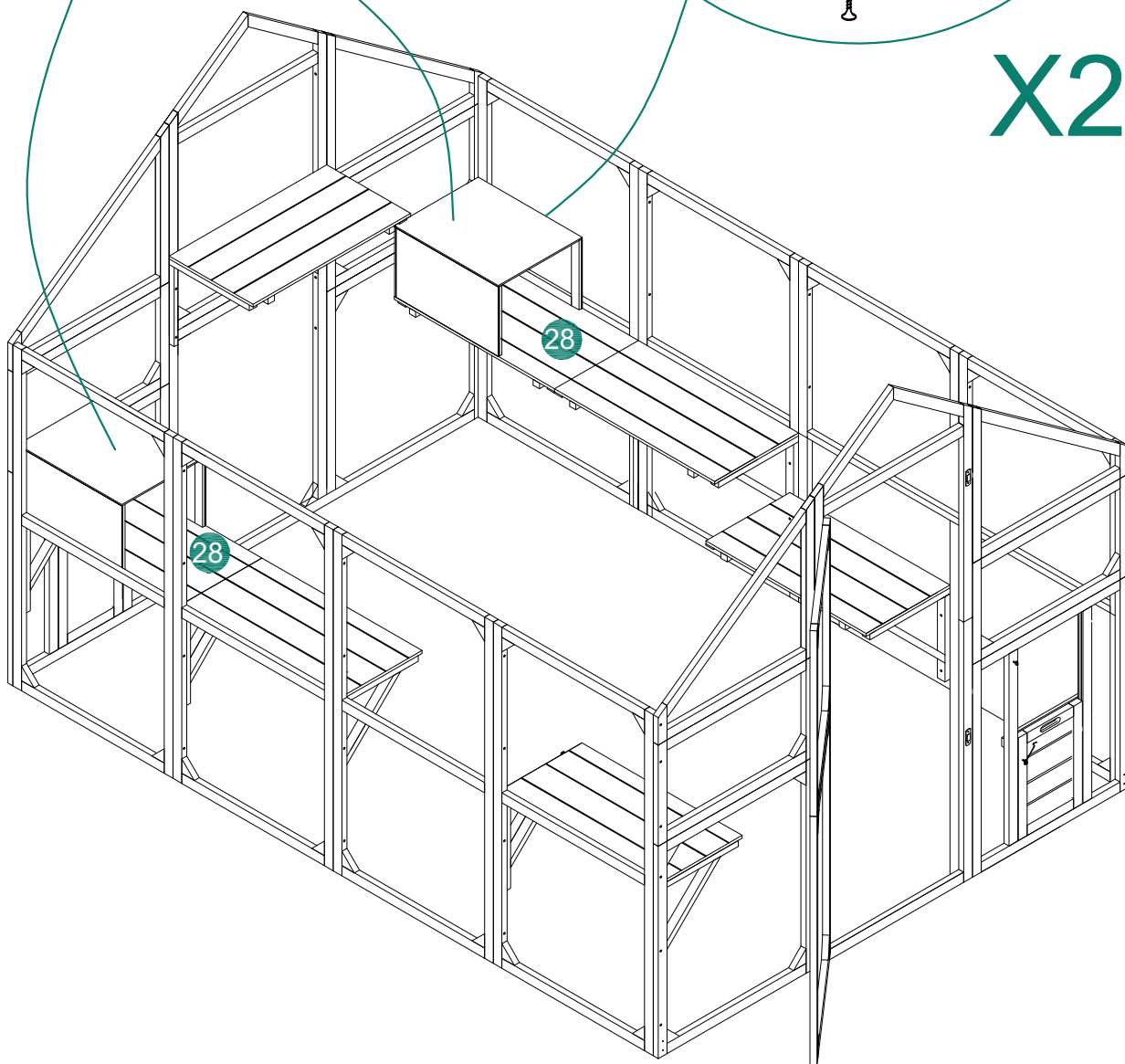

Dx32

STEP18

The kitten house is embedded with insulation materials, providing a warm and comfortable environment for the cat in winter.

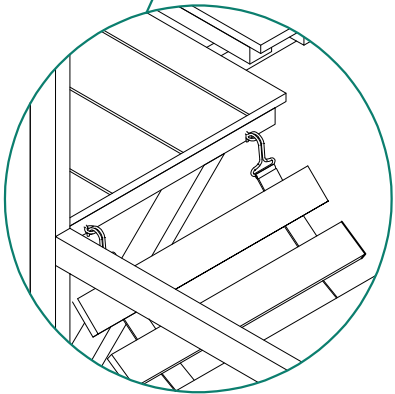
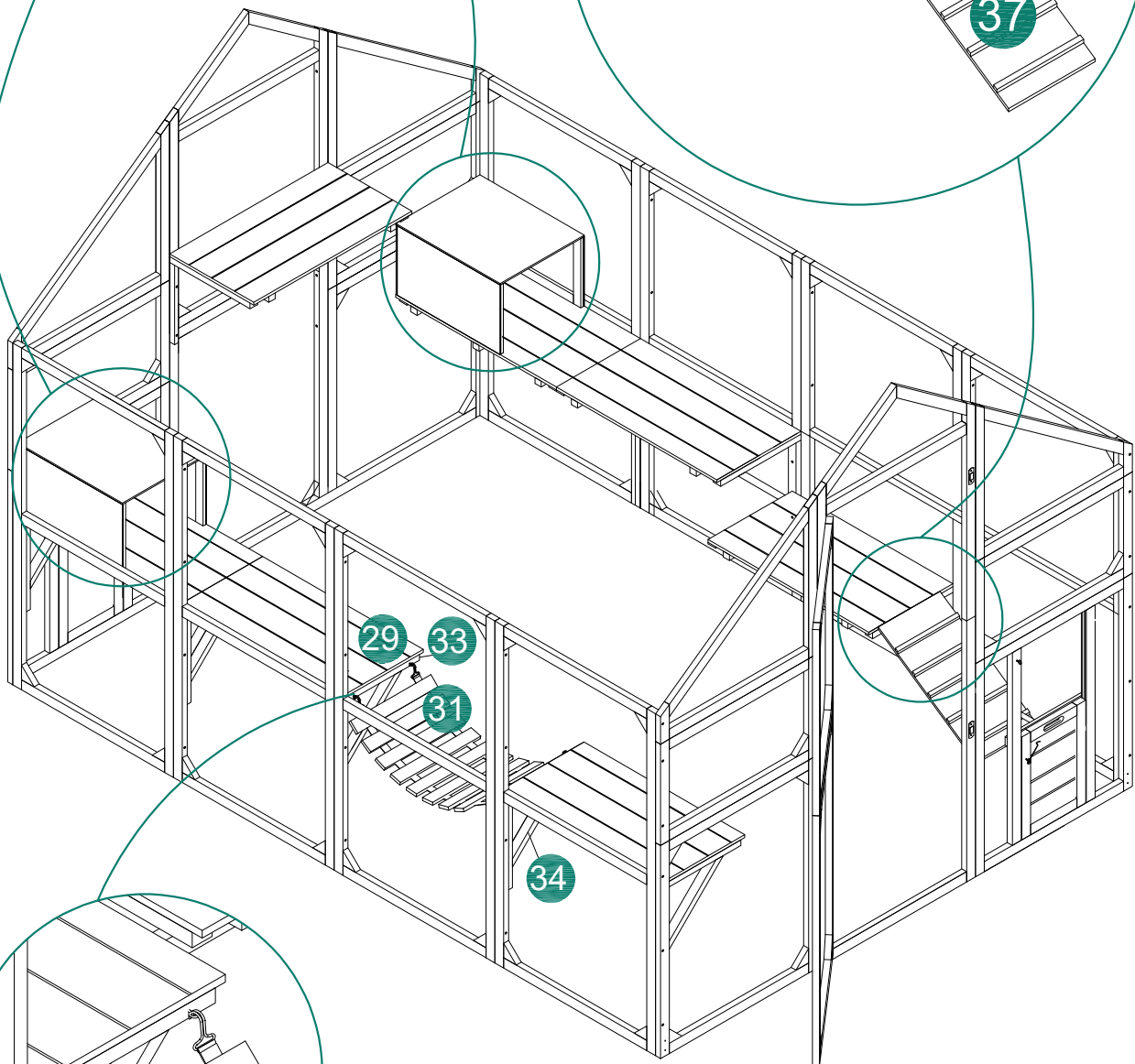
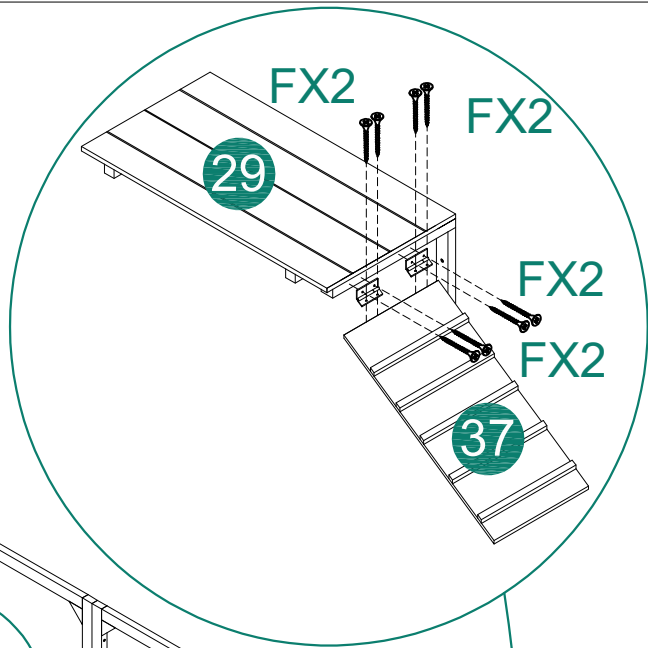

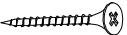
	Jx2
	Fx8

STEP19

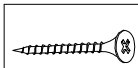
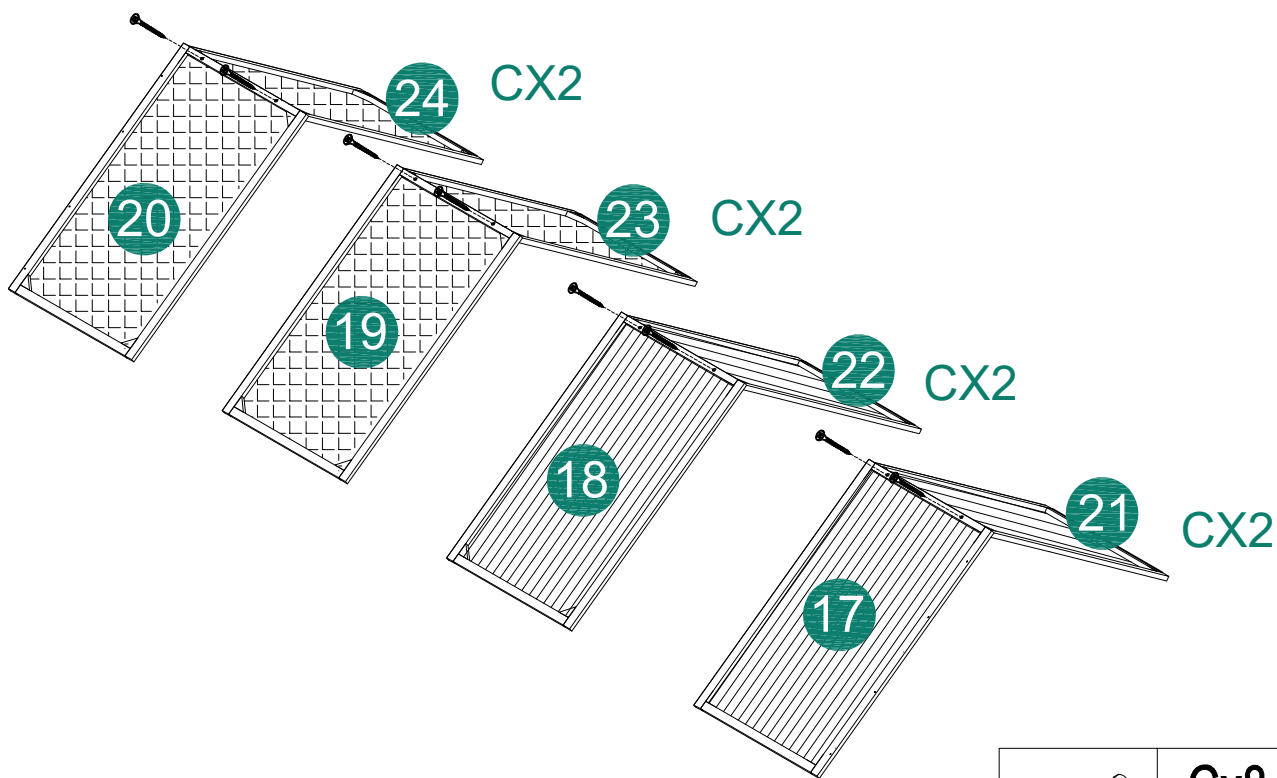

Cx8

STEP20

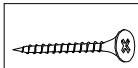
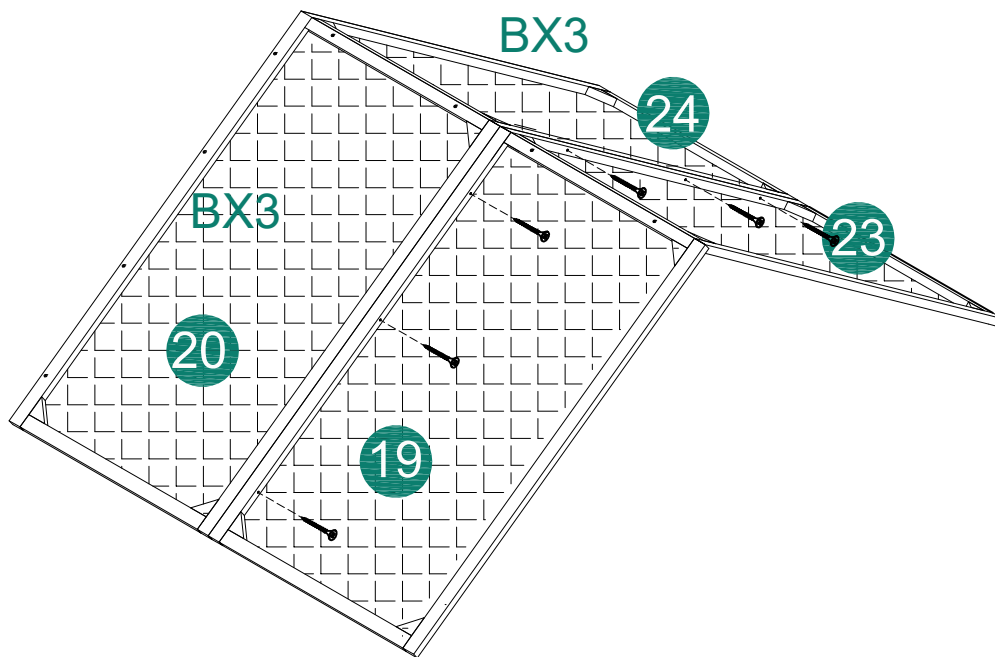

Bx6

STEP21

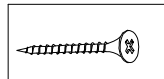
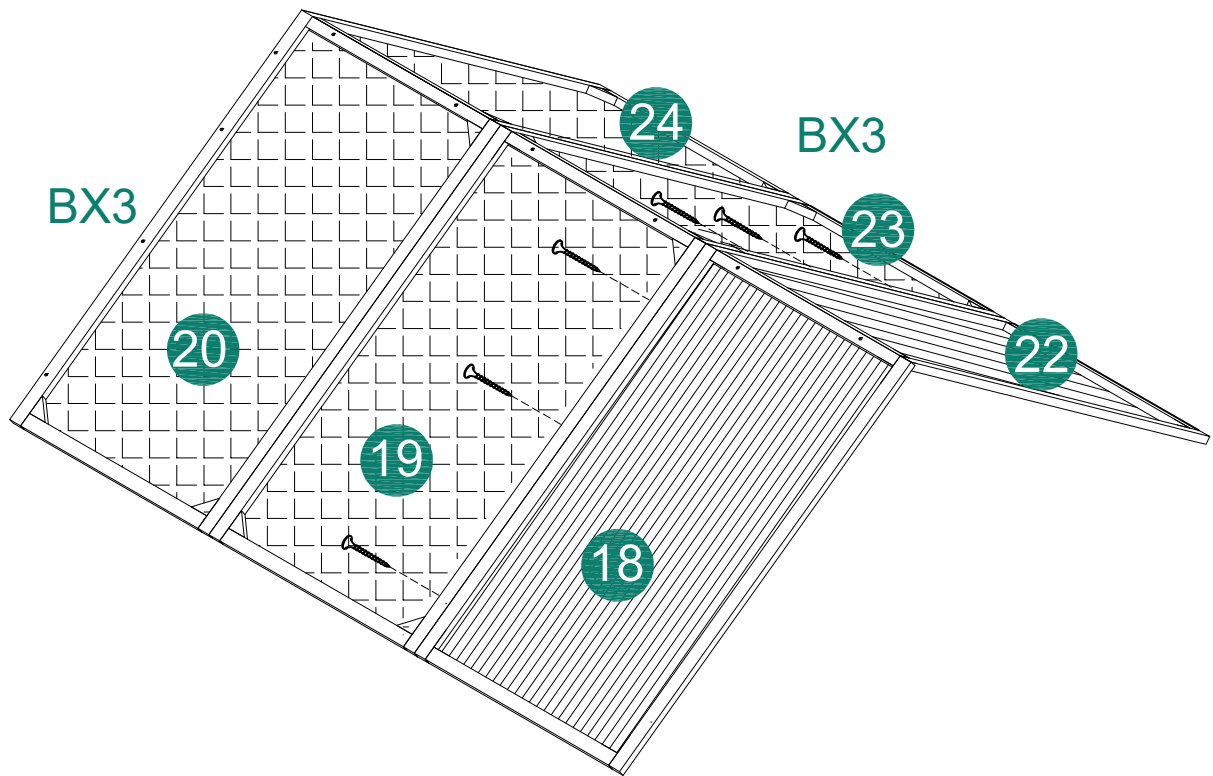

Bx6

STEP22

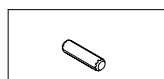
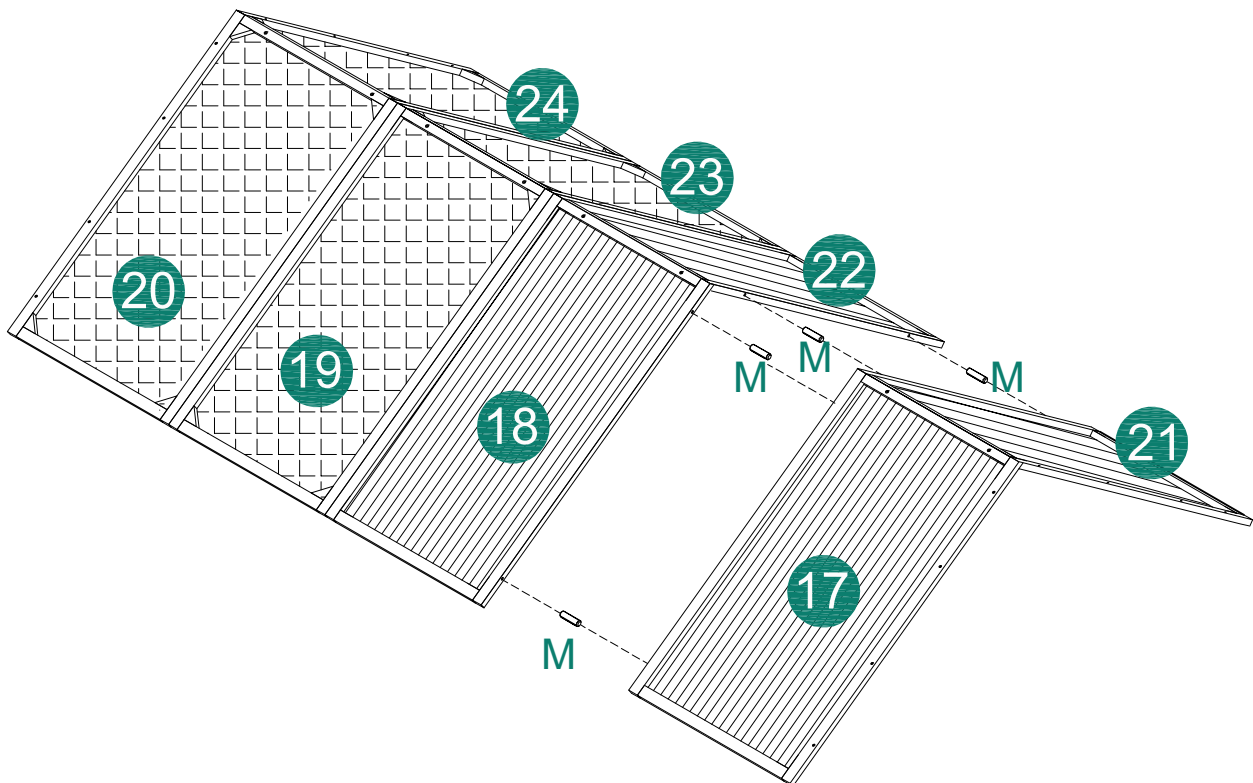

Ox4

STEP23

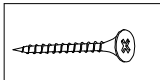
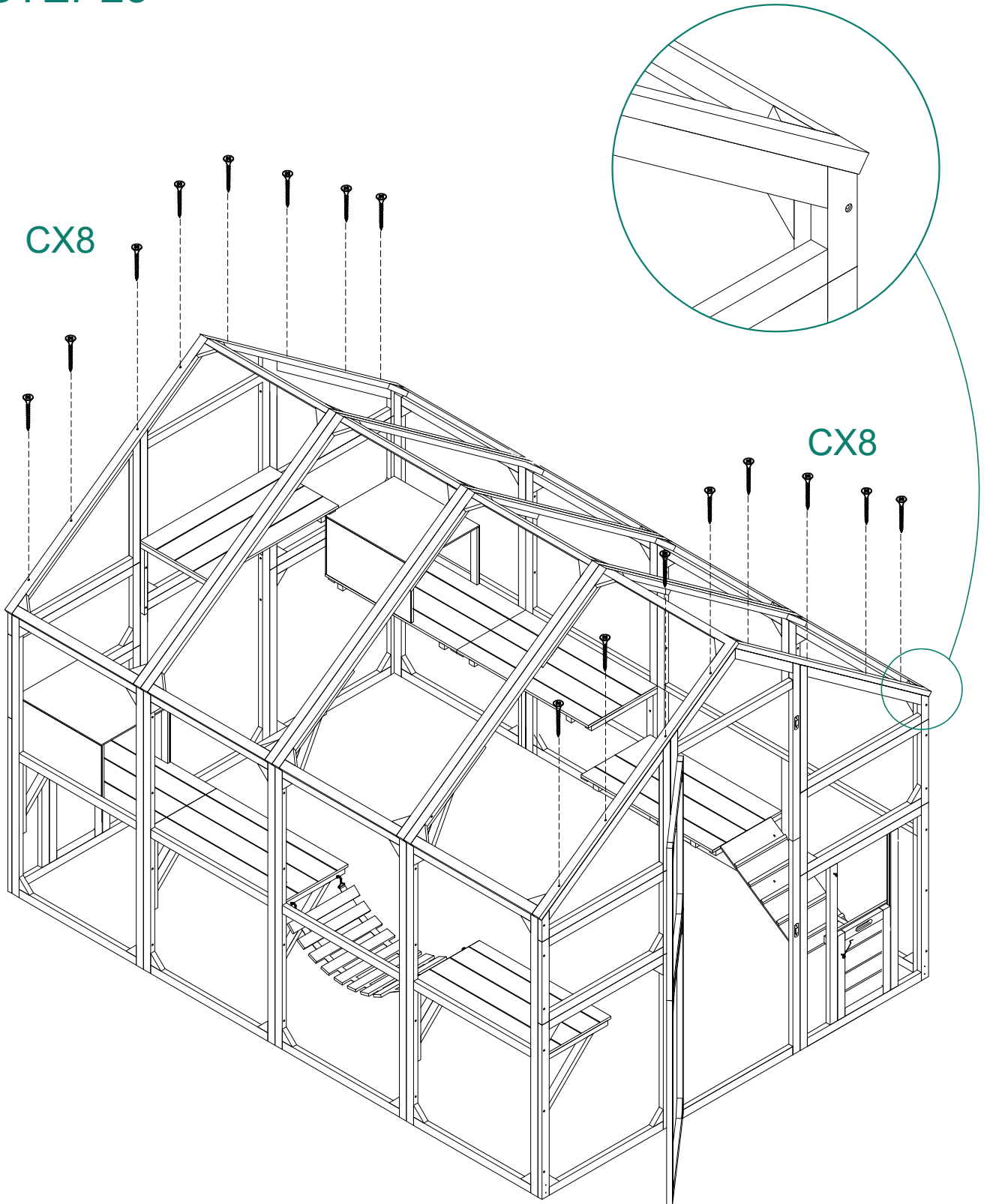

Cx16

STEP24

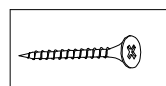
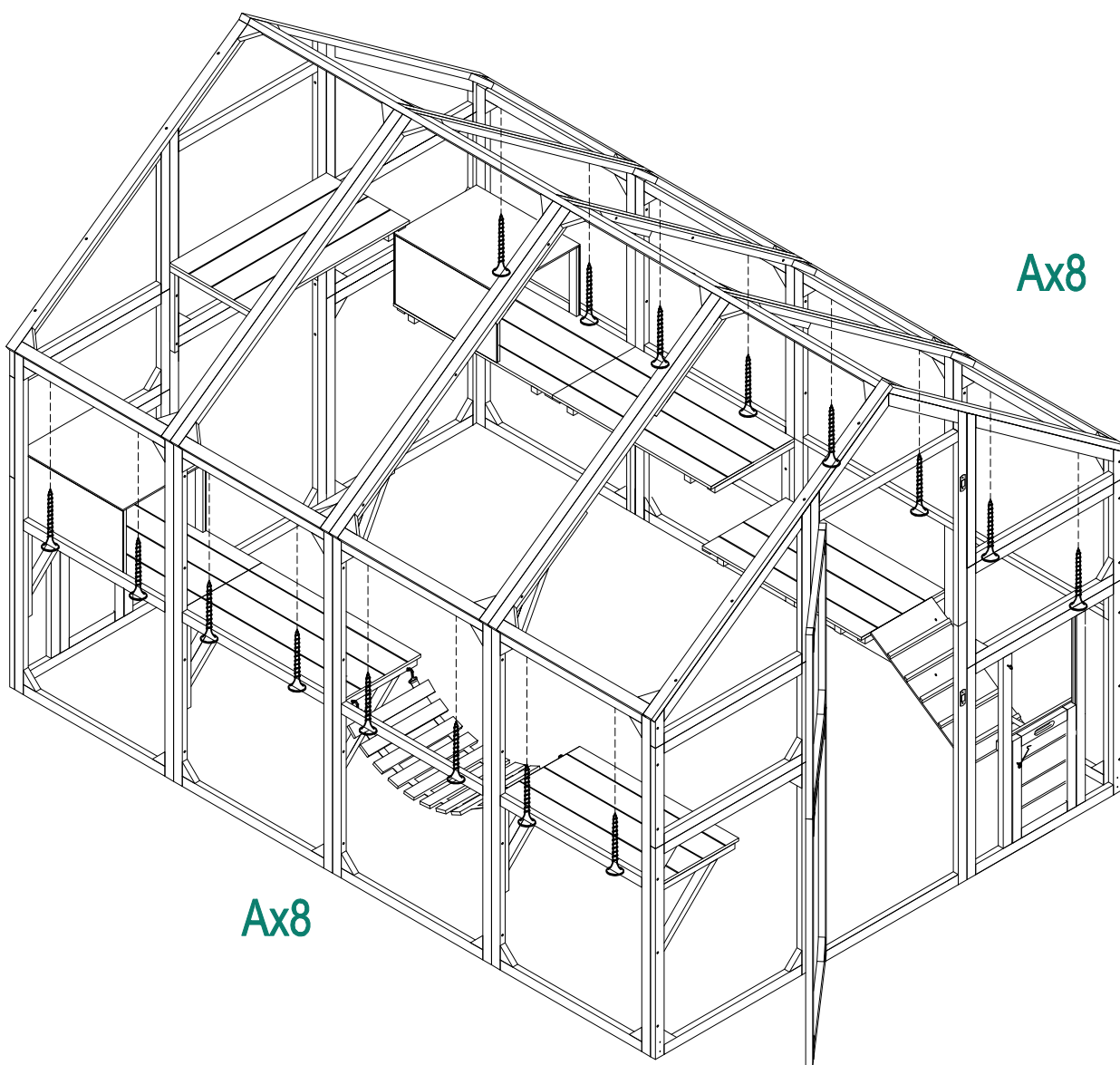

Ax16

STEP25

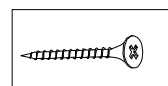
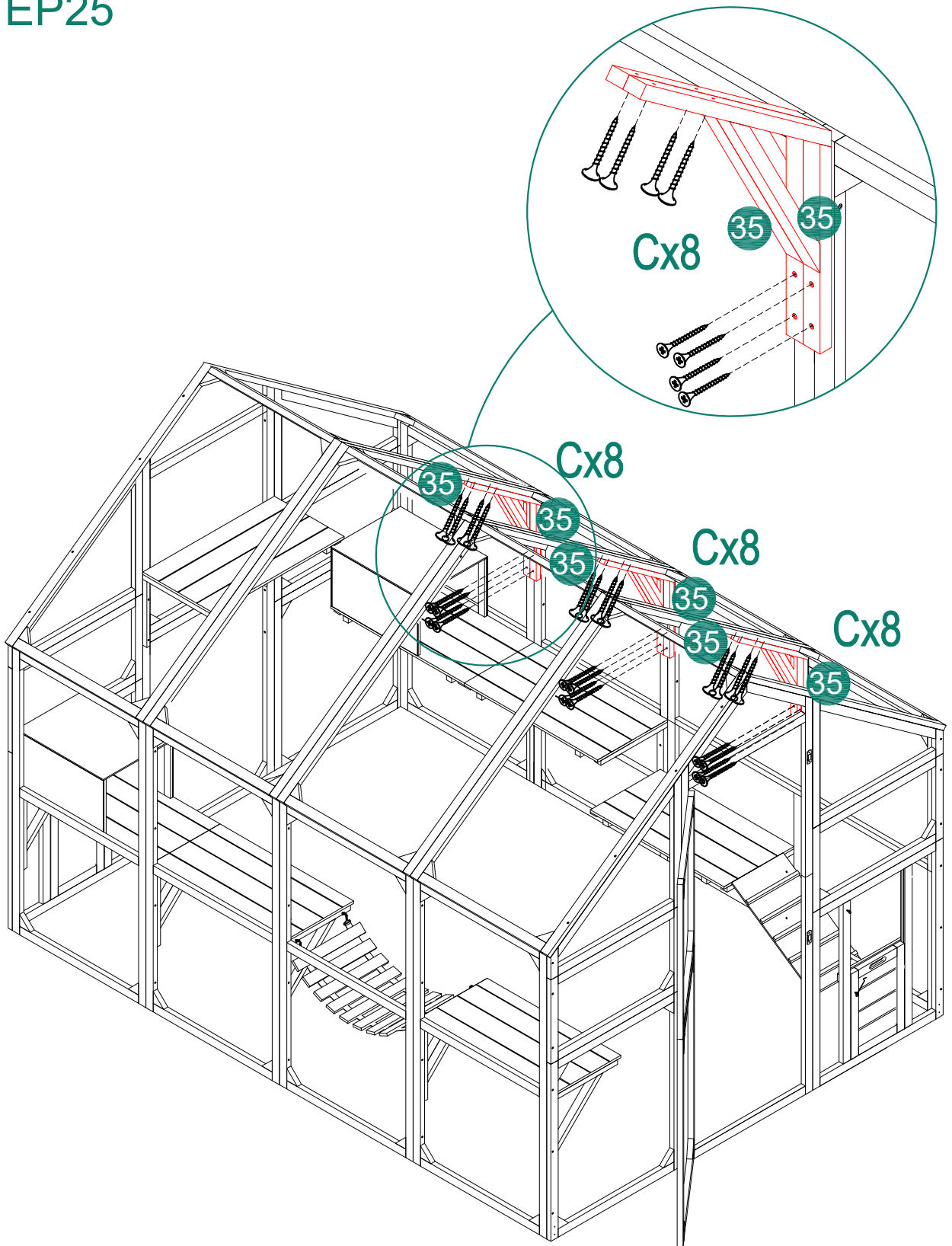

Cx24

STEP26

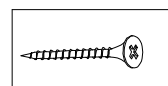
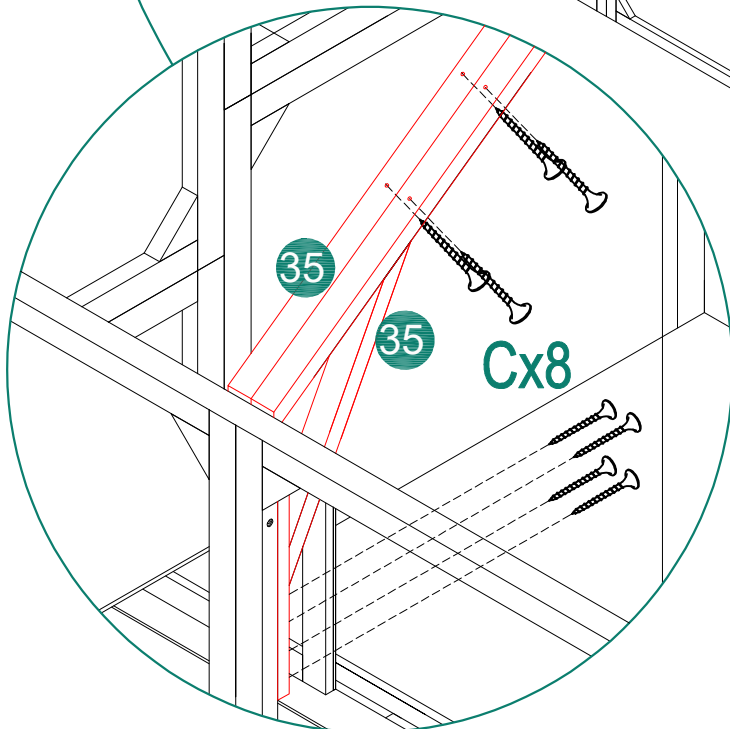
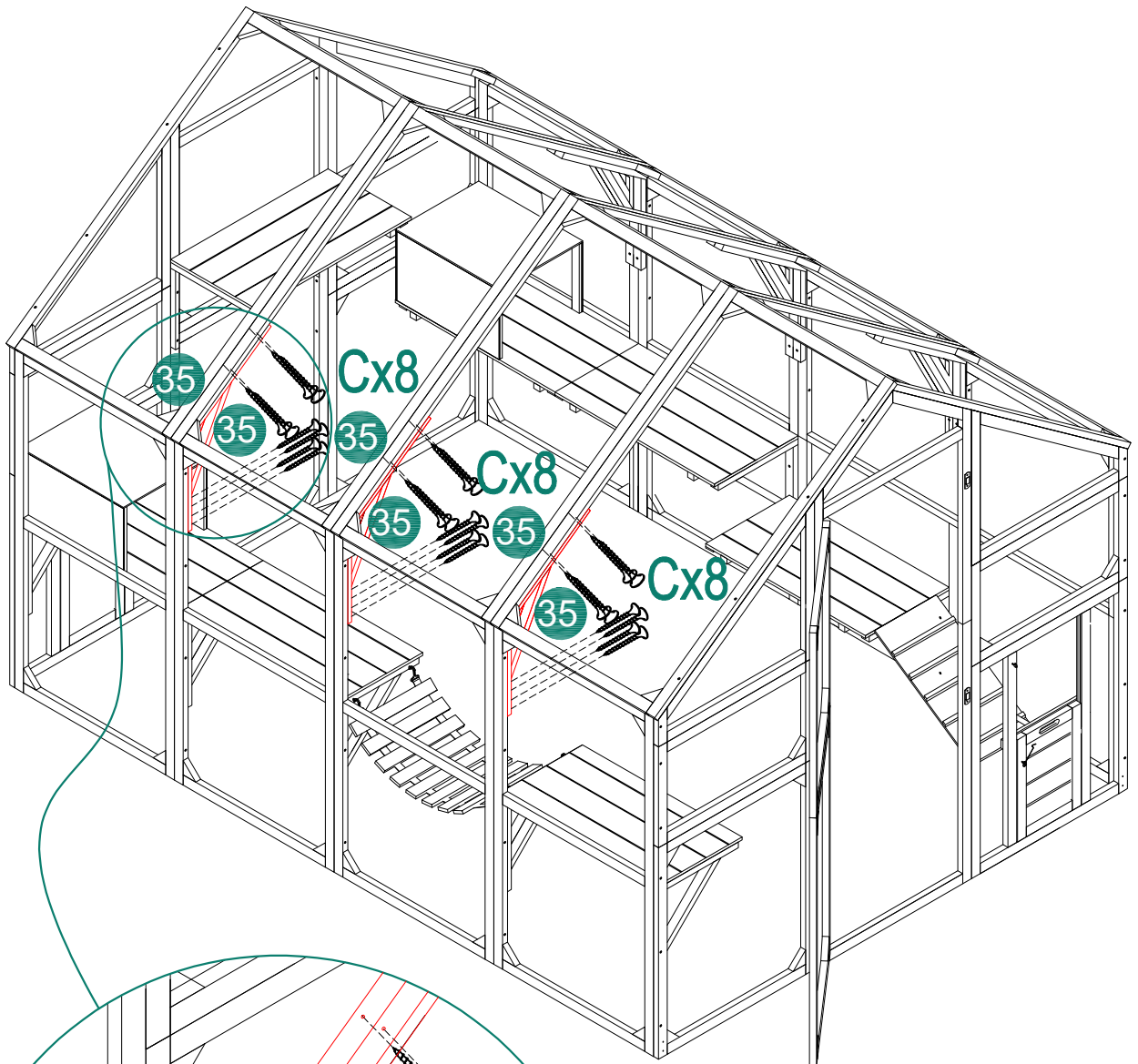

Cx24

STEP27

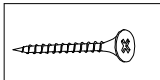
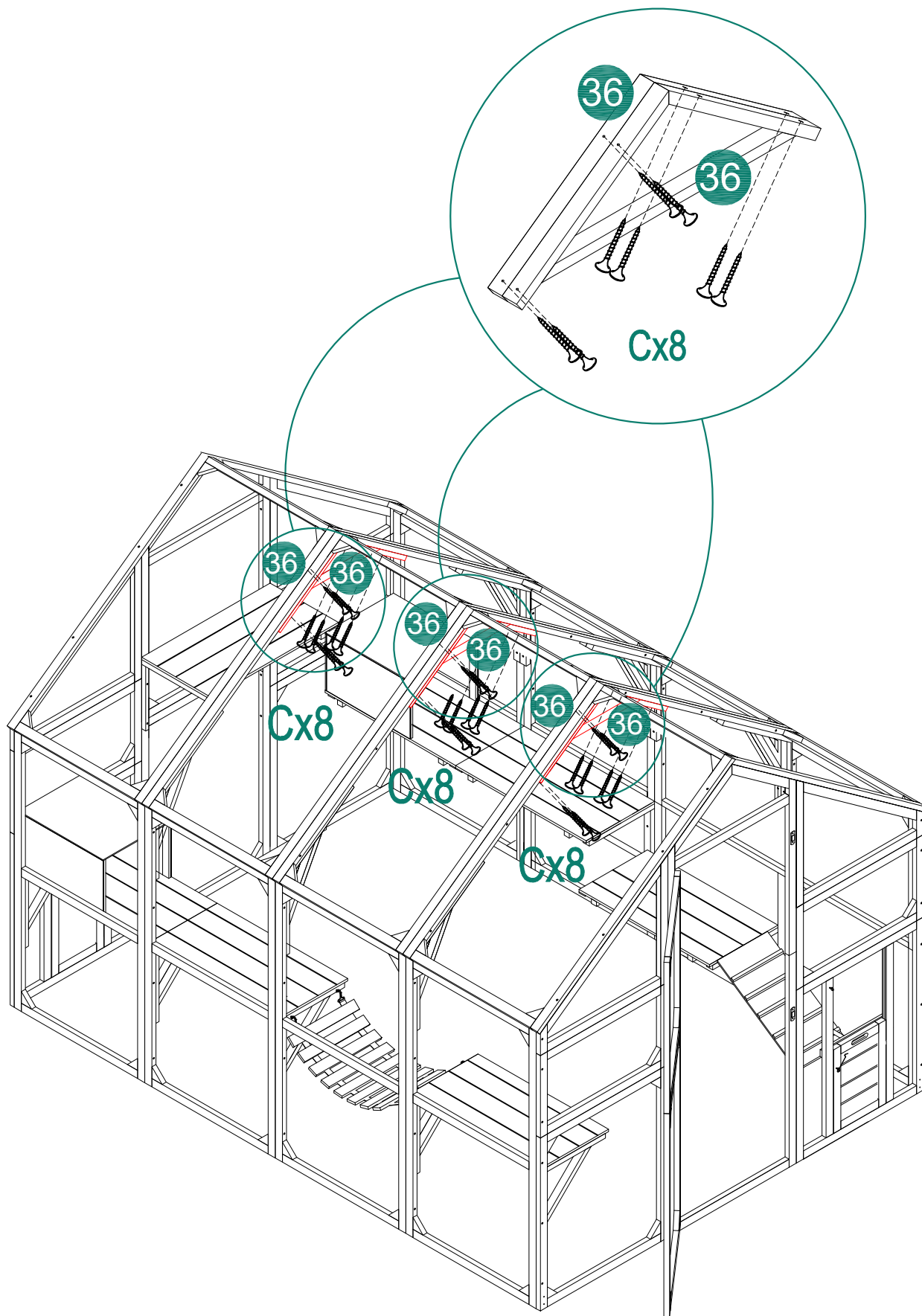

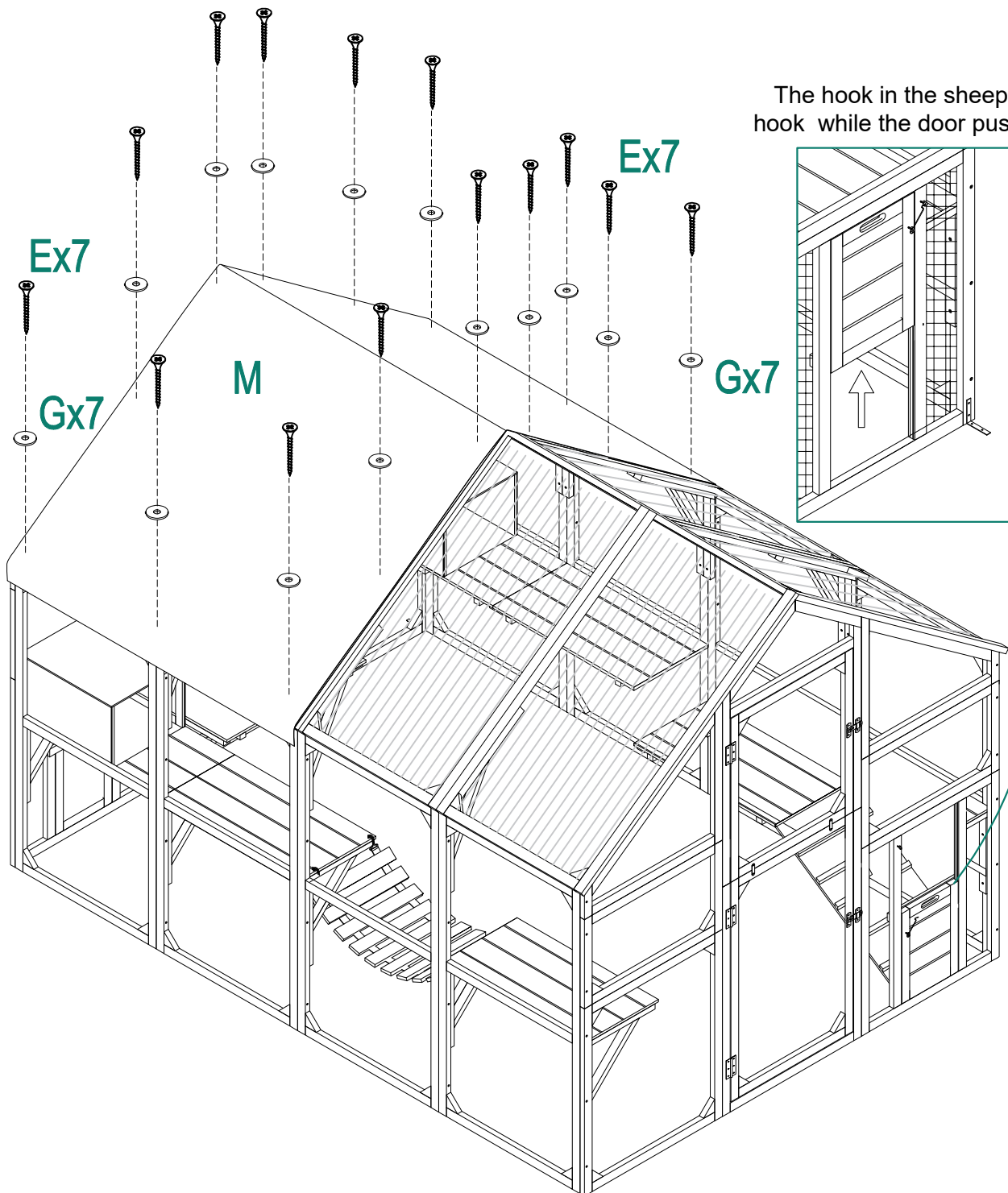

Cx24

STEP 28





The hook in the sheep eye hook while the door pushes up

	Ex14
	Mx1
	Gx14

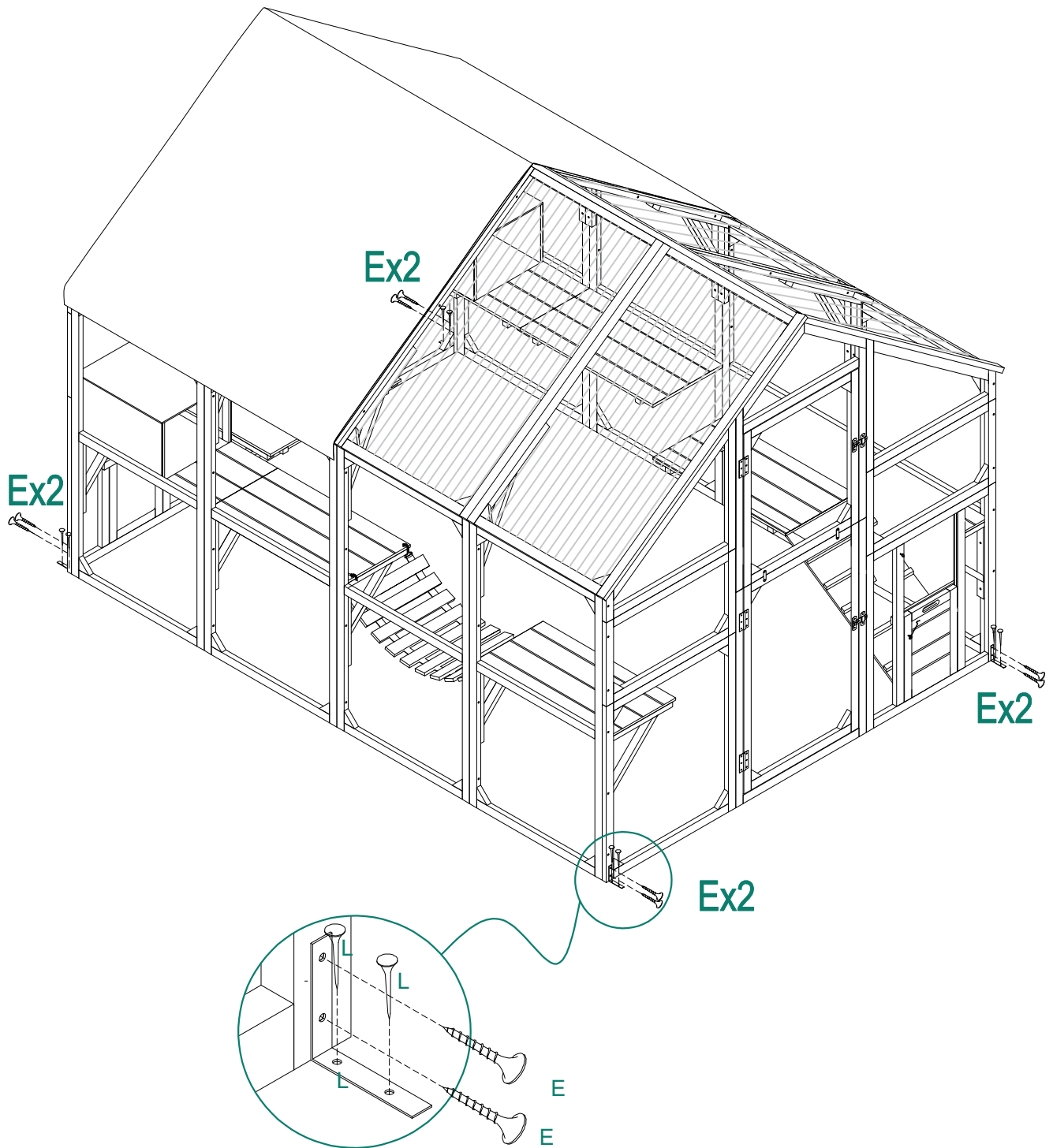
STEP 29



	Ex8
	Lx4

STEP30

