

INSTRUCTION MANUAL

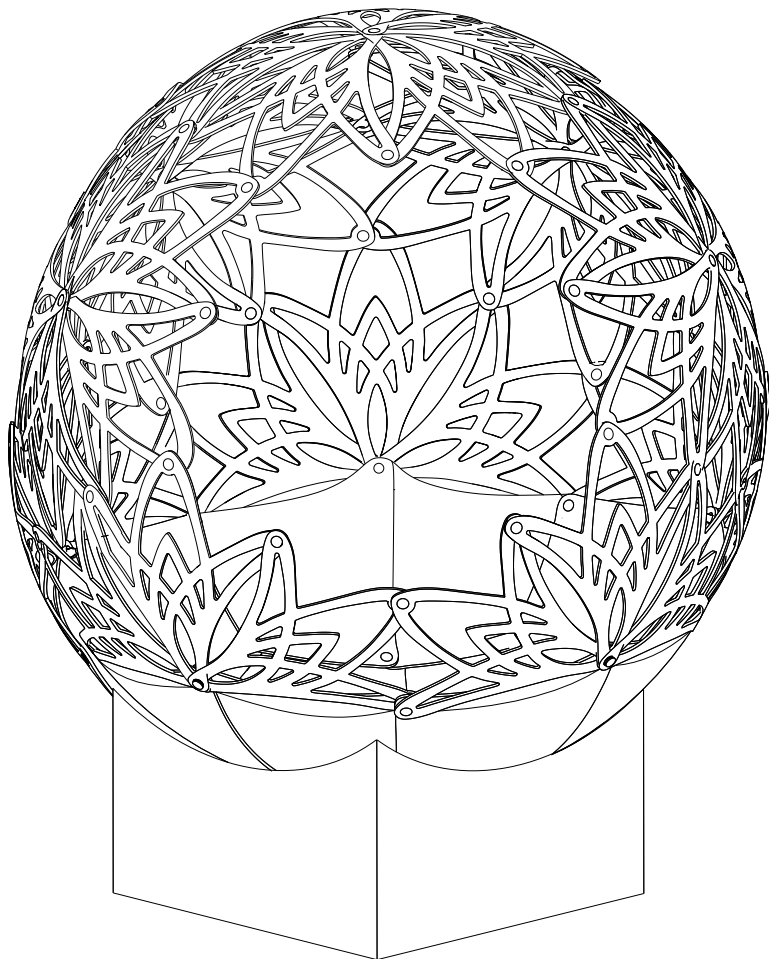

Introduction

Thank you for purchasing . This product is made of high quality materials and is intended to last. **Read all safety warnings, instructions, and illustrations provided in this manual.**

Safety Language

This instruction manual uses the following safety alert symbols and words to alert you to hazardous situations and your risk of personal injury or property damage. **Warning:** Indicates a potential injury or damage to property. **Hazardous:** could result in death or serious injury.

Product Use

Your product is designed for outdoor use **ONLY**.

DO NOT use under wet conditions or in presence of flammable liquids or gases.

DO NOT let children come into contact with the product.

Supervision is required when inexperienced operators use this product.

Locate the product at least **30-feet away** from any structure on firm, level, bare ground.

Never burn anything other than wood inside

NEVER use the without the base installed.

Specifications

Diameter: Varies

Material: Stainless Steel

Important Safety Instructions

▲ WARNING: RISK OF UNSAFE OPERATION

- Become familiar with the operation of this product.
- Keep operating area clear of all persons and pets. Do not touch when in use (the hot metal can burn).
- Keep children away from the product at all times.
- Keep all wood inside when in use.
- Never attempt to use to support other objects.
- Do not operate with missing, broken, or unauthorized parts.
- Never climb or stand on the , it was not designed to hold your weight.
- Always check local ordinances to be sure a fire is allowed in your area before using this product.

Parts

After unpacking, inspect parts carefully. If a part is missing or damaged, contact us

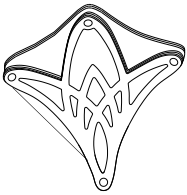

Combo Stack (5)

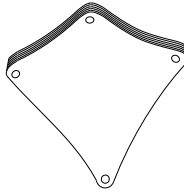

Base Stack (1)



Nut
(70)



Kite Stack (5)



Nut Wrench
(1)

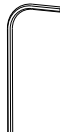

Hex Wrench
(1)

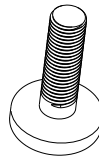

Bolt
(70)

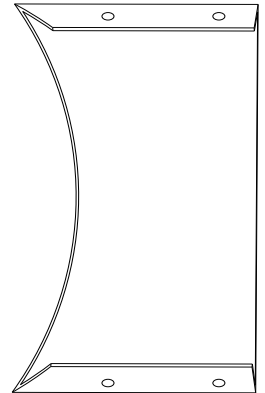

Base Wall
(5)

Using Bolts

Bolt heads must always face outside the fire pit during assembly.

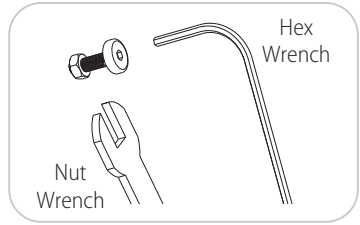
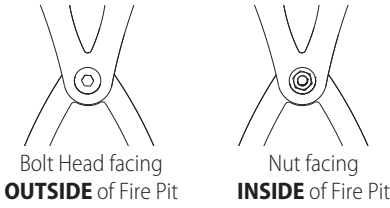

Key Points to Remember Before you Begin

Each tip must be connected in a specific way.

"4...3...4"



Remember this Golden Rule!



DO NOT TIGHTEN

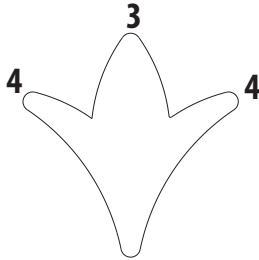
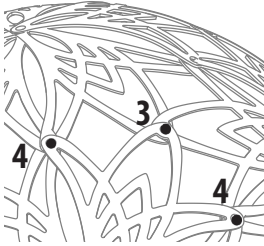

Key

- 4 = Pointed Side tips have 4 connection layers.
- 3 = Round Center tips have 3 connections layers.

NOTE: Connect adjacent Face Layers with adjacent Face Layers (upper with upper and lower with lower).

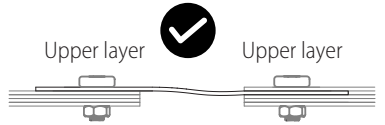
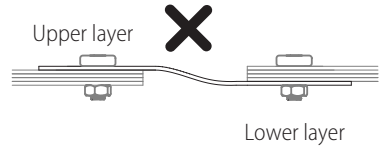

This will make for a smoother sphere shape when assembled.

Assembly

Each Kite tip must be connected in a specific way.

Spread each of the **STACKS** open to prepare them for assembly as shown.

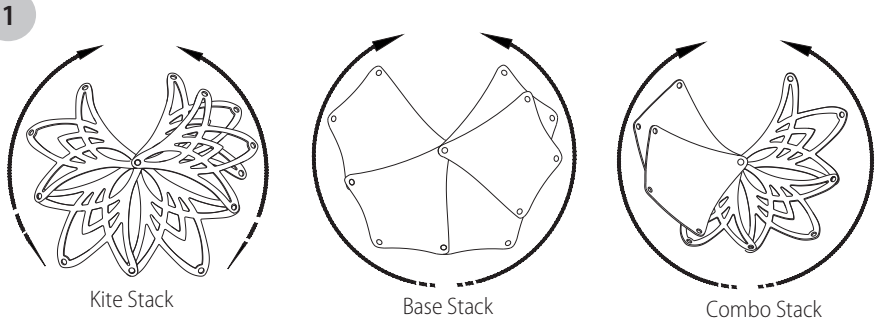

- 2 Expand the **BASE STACK** and assemble the **COMBO STACK** shown to form the Base I.



NOTE:
As you assemble, insert nuts and bolts but **DO NOT TIGHTEN** until all stacks have been attached.

First Combo Stack

Second Combo Stack

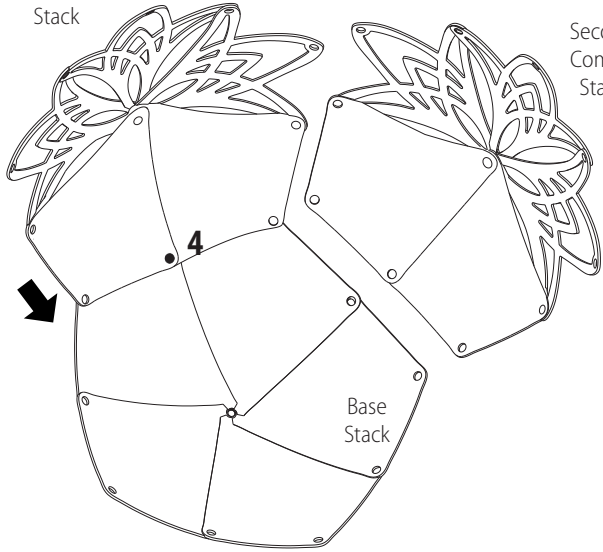

3

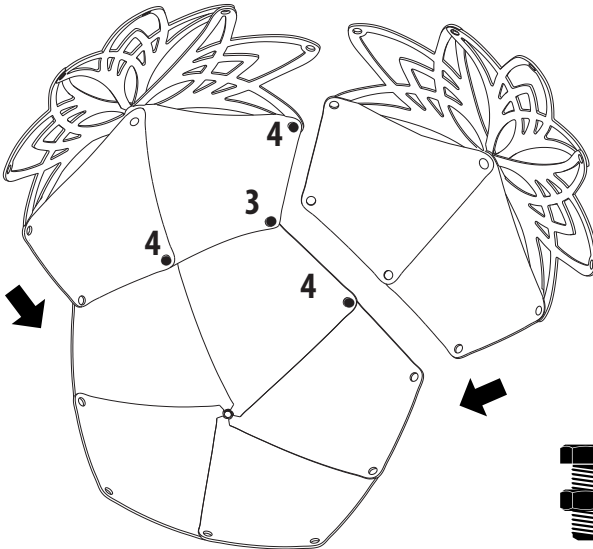

"4...3...4"



4

Continue connecting **COMBO STACKS** to **SECOND KITE STACK** with **BOLTS** as shown.

First Combo Stack



"4...3...4" **NOTE:**



As you begin to connect the Kite Stacks together, notice the **TIP PATTERN** that emerges.

Fifth Combo Stack

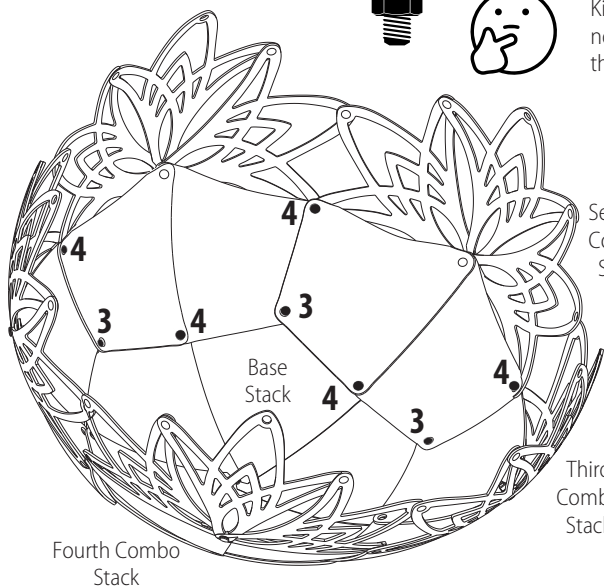

Second Combo Stack

Third Combo Stack

Fourth Combo Stack

Base Stack

5

Install the remaining **KITE STACKS** around the Bonefireball in another layer.

Kite Stack

Kite Stack

Kite Stack

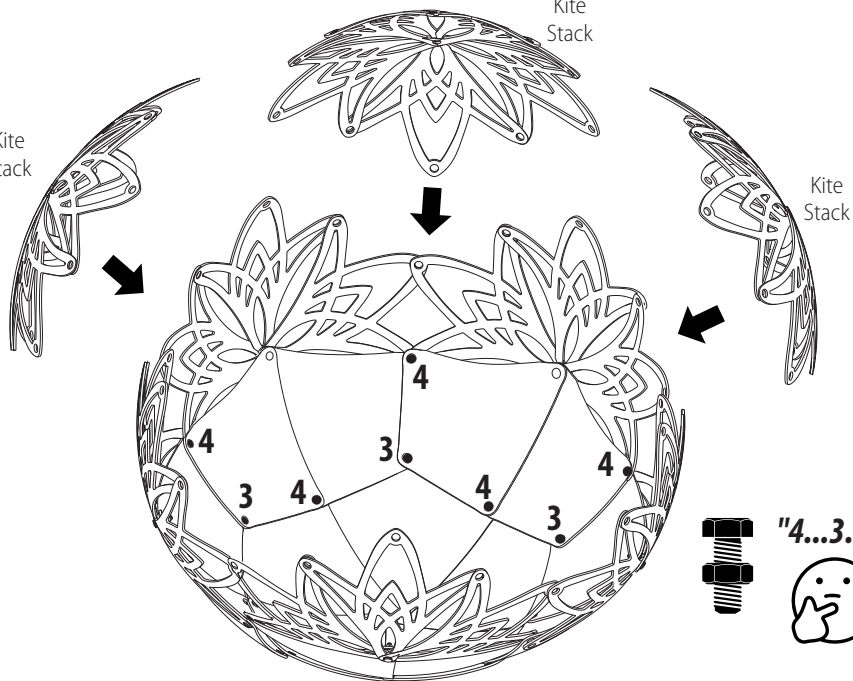

"4...3...4"



- 6 Continue to connect the **KITE STACKS** together and pay attention to the number of connections as shown in this top view.

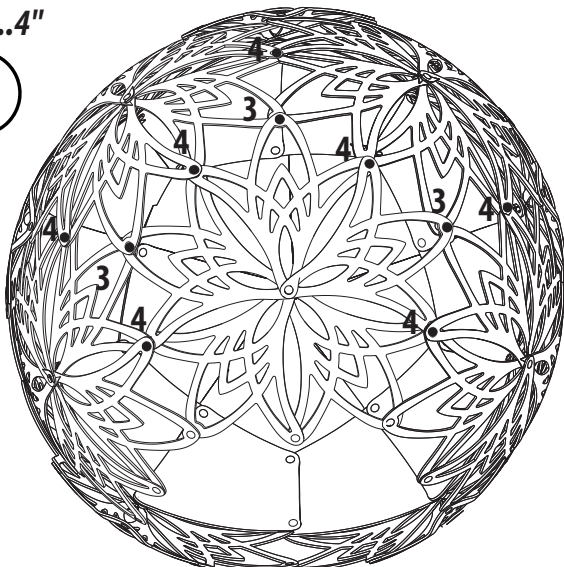

TOP VIEW

- 7 Continue to connect the **KITE STACKS** together, leaving an opening on one side of the (this opening allow logs to be inserted inside).

- 8 **TIGHTEN ALL BOLTS**



FRONT VIEW

- 9 Assemble the **BASE WALLS** into a pentagon shape using the Nuts and Bolts.

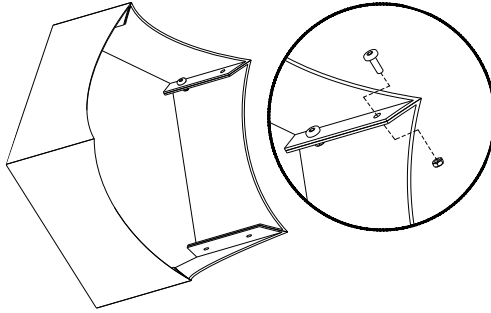

- 10 Place the sphere portion to the base.

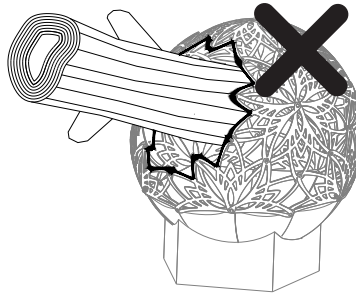
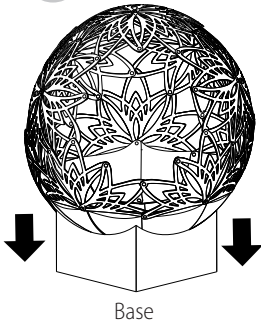

NOTE:
Insert wood completely inside the

DO NOT HANG WOOD OUT OF THE OPENING.



Never touch

when in use, it can burn.

Warranty

For refunds or If a part is missing or damaged, contact us

Maintenance

Occasionally inspect the Nuts and Bolts and tighten if necessary. Clean with warm soapy water when cool.

Disclaimer

This manual relates solely and exclusively to including but not limited to the operation thereof. Failure to adhere to this manual or to properly focus on the operation of the can result in serious injury and even death. Always operate the in a safe manner and in full compliance with this manual. is not liable for any injuries or damages to any operators, property, or bystanders incurred as a result of using this product. cannot be held liable for any and all errors in this manual or for any incidental or consequential damages that result from the use of the material presented in this manual. This manual contains proprietary information. All rights are reserved. No part of this manual may be photocopied, reproduced or translated to another language without the written consent.