

MICROWAVE OVEN

INSTRUCTION MANUAL

Model: FMO09BLKSS



Read these instructions carefully before using your microwave oven. If you follow the instructions, your oven will provide you with many years of good service.

SAVE THESE INSTRUCTIONS CAREFULLY

(rev. 5/30/2024 MD)

FARBERWARE®

Farberware is a registered trademark of Farberware Licensing Company, LLC
Manufactured and sold pursuant to a license from Farberware Licensing Company, LLC
© 2024 Farberware Licensing Company, LLC. All rights reserved.

Table of Contents

PRECAUTIONS	4
SPECIFICATIONS.....	4
SAFETY.....	4
GROUNDING	6
UTENSILS.....	8
SETTING UP YOUR OVEN	10
CONTROL PANEL.....	12
OPERATION	13
MAINTENANCE.....	19
WARRANTY INFORMATION	20

PRECAUTIONS TO AVOID POSSIBLE EXPOSURE TO EXCESSIVE MICROWAVE ENERGY

- a. Do not attempt to operate this oven with the door open since open-door operation can result in harmful exposure to microwave energy. It is important not to defeat or tamper with the safety interlocks.
- b. Do not place any object between the oven front face and the door or allows soil or cleaner residue to accumulate on sealing surfaces.
- c. Do not operate the oven if it is damaged. It is particularly important that the oven door close properly and that there is no damage to the:
 1. DOOR (bent)
 2. HINGEST AND LATCHES (broken or loosened)
 3. DOOR SEALS AND SEALING SURFACES
- d. The oven should not be adjusted or repaired by anyone except properly qualified service personnel.

SPECIFICATIONS

Model:	FMO09BLKSS
Rated Voltage:	120V~60Hz
Rated Input Power(Microwave):	1400W
Rated Output Power(Microwave):	900W



WARNING:

This product can expose you to chemicals including Phthalates or other chemicals which are known to the State of California to cause cancer, birth defects and other reproductive harm.

For more information, visit www.P65Warnings.ca.gov

IMPORTANT SAFETY INSTRUCTIONS

When using electrical appliances basic safety precautions should be followed, including the following:

WARNING - To reduce the risk of burns, electric shock, fire, injury to persons or exposure to excessive microwave energy:

1. Read all instructions before using the appliance.
2. Read and follow the specific: "PRECAUTIONS TO AVOID POSSIBLE EXPOSURE TO EXCESSIVE MICROWAVE ENERGY" found on page 4.
3. This appliance must be grounded. Connect only to properly grounded outlet. See "GROUNDING INSTRUCTIONS" found on page 6.
4. Install or locate this appliance only in accordance with the provided installation instructions.
5. Some products such as whole eggs and sealed containers - for example, closed glass jars - are able to explode and should not be heated in this oven.
6. Use this appliance only for its intended use as described in the manual. Do not use corrosive chemicals or vapors in this appliance. This type of oven is specifically designed to heat, cook or dry food. It is not designed for industrial or laboratory use.
7. HOT CONTENTS CAN CAUSE SEVERE BURNS. DO NOT ALLOW CHILDREN TO USE THE MICROWAVE. Use caution when removing hot items.
8. Do not operate this appliance if it has a damaged cord or plug, if it is not working properly, or if it has been damaged or dropped.
9. This appliance should be serviced only by qualified service personnel. Contact nearest authorized service facility for examination, repair, or adjustment.
10. Do not cover or block any openings on the appliance.
11. Do not store this appliance outdoors. Do not use this product near water - for example, near a kitchen sink, in a wet basement, near a swimming pool, or similar location.
12. Do not immerse cord or plug in water.
13. Keep cord away from heated surface.
14. Do not let cord hang over edge of table or counter.
15. When cleaning surfaces of door and oven that comes together on closing the door, use only mild, nonabrasive soaps, or detergent applied with a sponge or soft cloth.
16. To reduce the risk of fire in the oven cavity:
 1. Do not overcook food. Carefully attend appliance when paper, plastic, or other combustible materials are placed inside the oven to facilitate cooking.
 2. Remove wire twist-ties from paper or plastic bag before placing bag in oven.
 3. If material inside of the oven ignite, keep oven door closed, turn oven off, and disconnect the power cord, or shut off power at the fuse or circuit breaker panel.
 4. Do not use the cavity for storage purposes. Do not leave paper products, cooking utensils, or food in the cavity when not in use.

17. Liquids, such as water, coffee, or tea are able to be overheated beyond the boiling point without appearing to be boiling. Visible bubbling or boiling when the container is removed from the microwave oven is not always present. THIS COULD RESULT IN VERY HOT LIQUID SUDDENLY BOILING OVER WHEN THE CONTAINER IS DISTURBED OR A UTENSIL IS INSERTED INTO THE LIQUID.

To reduce the risk of injury to persons:

1. Do not overheat the liquid.
2. Stir the liquid both before and halfway through heating it.
3. Do not use straight-sided containers with narrow necks.
4. After heating, allow the container to stand in the microwave oven for a short time before removing the container.
5. Use extreme care when inserting a spoon or other utensil into the container.

SAVE THESE INSTRUCTIONS

HOUSEHOLD USE ONLY (NOT FOR COMMERCIAL USE)

GROUNDING INSTRUCTIONS

This appliance must be grounded. In the event of an electrical short circuit, grounding reduces the risk of electric shock by providing an escape wire for the electric current. This appliance is equipped with a cord having a grounding wire with a grounding plug. The plug must be plugged into an outlet that is properly installed and grounded.

WARNING - Improper use of the grounding can result in a risk of electric shock. Consult a qualified electrician or serviceman if the grounding instructions are not completely understood, or if doubt exists as to whether the appliance is properly grounded. If it is necessary to use an extension cord, use only a 3-wire extension cord that has a 3-blade grounded plug, and 3-slot receptacle that will accept the plug on the appliance. The marked rating of the extension cord shall be equal to or greater than the electrical rating of the appliance.

DANGER - Electric Shock Hazard:

Touching some of the internal components can cause serious personal injury or death. Do not disassemble this appliance.

WARNING - Electric Shock Hazard:

Improper use of the grounding can result in electric shock. Do not plug into an outlet until appliance is properly installed and grounded.

1. A short power-supply cord is provided to reduce the risks resulting from becoming entangled in or tripping over a longer cord.
2. Longer cord sets or extension cords are available and may be used if care is exercised in their use.
3. If a long cord or extension cord is used:
 1. The marked electrical rating of the cord set or extension cord should be at least as great as the electrical rating of the appliance.
 2. The extension cord must be a grounding-type 3-wire cord.
 3. The longer cord should be arranged so that it will not drape over the counter top or tabletop where it can be pulled on by children or tripped over unintentionally.

RADIO INTERFERENCE

1. Operation of the microwave oven may cause interference to your radio, TV or similar equipment.
2. When there is interference, it may be reduced or eliminated by taking the following measures:
 1. Clean door and sealing surface of the oven.
 2. Reorient the receiving antenna of radio or television.
 3. Relocate the microwave oven with respect to the receiver.
 4. Move the microwave oven away from the receiver.
 5. Plug the microwave oven into a different outlet so that microwave oven and receiver are on different branch circuits.
3. This equipment generates, uses and can radiate radio frequency energy and, if not installed and used in accordance with the instructions, may cause harmful interference to radio communications. However, there is no guarantee that interference will not occur in a particular installation. If this equipment does cause harmful interference to radio or television reception, which can be determined by turning the equipment off and on, the user is encouraged to try to correct the interference by one or more of the following measures:
 1. Reorient or relocate the receiving antenna.
 2. Increase the separation between the equipment and receiver.
 3. Connect the equipment into an outlet on a circuit different from that to which the receiver is connected.
 4. Consult the dealer or an experienced radio/TV technician for help.

**This device complies with part 18
of the FCC Rules.**

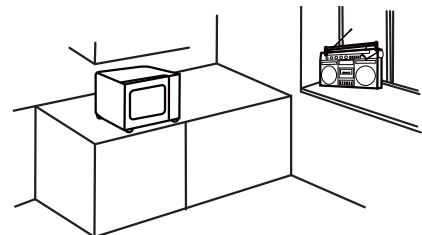

UTENSILS



CAUTION - Personal Injury Hazard

Tightly-closed utensils could explode. Closed containers should be opened and plastic pouches should be pierced before cooking.

See the instructions on “Materials you can use in microwave oven.” or “Materials cannot be used in microwave oven.”

There may be certain non-metallic utensils that are not safe to use for microwaving. If in doubt, you can test the utensil in question by following the procedure below.

Utensil Test:

1. Fill a microwave-safe container with 1 cup or cold water (250ml) along with the utensil in question.
2. Cook on maximum power for 1 minute.
3. Carefully feel the utensil. If the empty utensil is warm, do not use it for microwave cooking.
4. Do not exceed 1 minute cooking time.

NOTE - KEEP THE CAVITY CLEAN

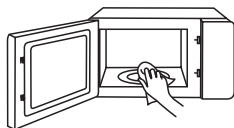
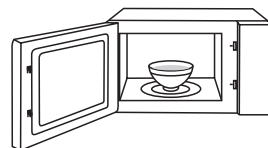

MATERIALS YOU CAN USE IN MICROWAVE OVEN

Utensils	Remarks
Browning Dish	Follow manufacturer* instructions. The bottom of browning dish must be at least 3/16 inch (5mm) above the turntable. Incorrect usage may cause the turntable to break.
Dinnerware	Microwave-safe only. Follow manufacturer's instructions. Do not use cracked or chipped dishes.
Glass jars	Always remove lid. Use only to heat food until just warm. Most glass jars are not heat resistant and may break.
Glassware	Heat-resistant oven glassware only. Make sure there is no metallic trim. Do not use cracked or chipped dishes.
Oven cooking bags	Follow manufacturer* instructions. Do not close with metal tie. Make slits to allow steam to escape.
Paper plates and cups	Use for short term cooking/warming only. Do not leave oven unattended while cooking.
Paper towels	Use to cover food for reheating and absorbing fat. Use with supervision for a short-term cooking only.
Parchment paper	Use as a cover to prevent splattering or a wrap for steaming.
Plastic	Microwave-safe only. Follow the manufacturer* instructions. Should be labeled "Microwave Safe". Some plastic containers soften, as the food inside gets hot. "Boiling bags" and tightly closed plastic bags should be slit, pierced or vented as directed by package.
Plastic wrap	Microwave-safe only. Use to cover food during cooking to retain moisture. Do not allow plastic wrap to touch food.
Thermometers	Microwave-safe only (meat and candy thermometers).
Wax papers	Use as a cover to prevent splattering and retain moisture.

MATERIALS TO BE AVOIDED IN MICROWAVE OVEN

Utensils	Remarks
Aluminum tray	May cause arcing. Transfer food into microwave-safe dish.
Food carton with metal handle	May cause arcing. Transfer food into microwave-safe dish.
Metal or metal-trimmed utensils	Metal shields the food from microwave energy. Metal trim may cause arcing.
Metal twist ties	May cause arcing and could cause a fire in the oven.
Paper bags	May cause a fire in the oven.
Plastic foam	Plastic foam may melt or contaminate the liquid inside when exposed to high temperature.
Wood	Wood will dry out when used in the microwave oven and may split or crack.

SETTING UP YOUR OVEN

Names of Oven Parts and Accessories

(In case of any differences between the appliance and the pictures in this manual, the product shall prevail.)

Remove the oven and all materials from the carton and oven cavity.
Your oven comes with the following accessories:

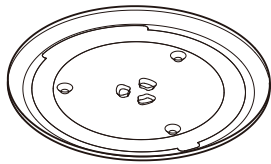

Glass Tray

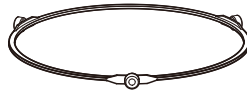

Turntable Ring Assembly

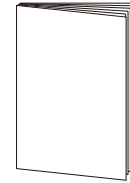

Instruction Manual

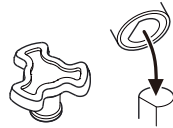

Turntable Shaft

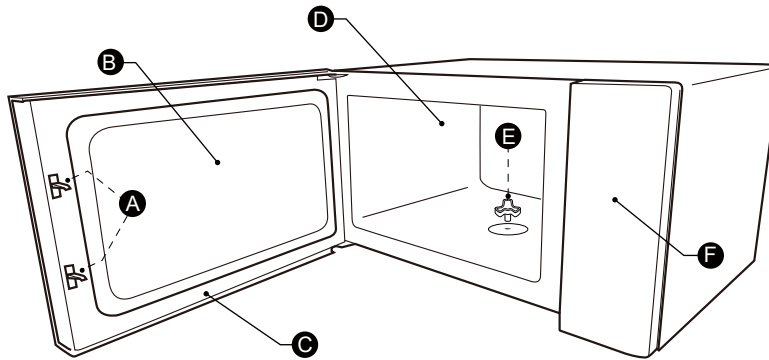

- A. Safety interlock system
- B. Observation window
- C. Door assembly

- D. Oven capacity
- E. Turntable shaft
- F. Control panel

Turtable Installation

Cleaning the cooking compartment and putting the turtable in place. For new installations, make sure all packaging and shipping tape has been removed from the turtable shaft. Before using the appliance to prepare food for the first time, you will need to put the turtable in place correctly. You must clean the cooking compartment and accessories.

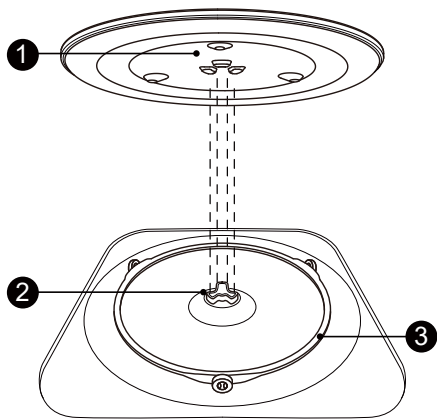

How to put the turtable in place:

1. Place the turtable ring assembly ③ into the recess in the cooking compartment.
2. Place the glass tray ① on the turtable ring assembly ③. Fit the raised, curved lines in the center of the glass tray bottom between the three spokes of the shaft. Make sure that the glass tray ① engages in the turtable shaft ② in the centre of the cooking compartment floor. The rollers on the shaft should fit inside the turtable bottom ridge.

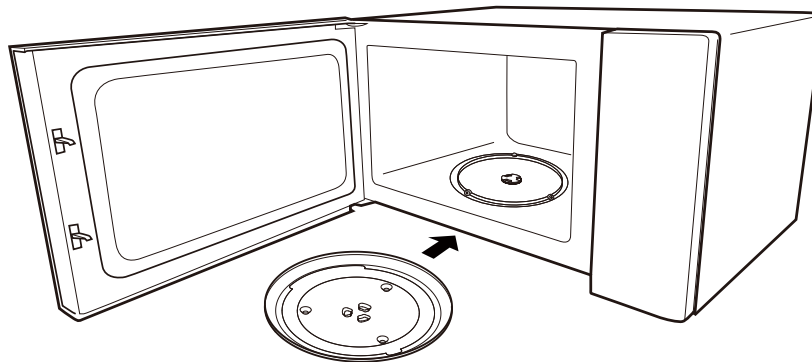

Notes:

1. Never use the appliance without the turtable. Make sure that it is properly engaged. The turtable can turn clockwise or anti-clockwise.
2. Never place the glass tray upside down. The glass tray should never be restricted.
3. Both glass tray and turtable ring assembly must always be used during cooking.
4. All food and containers of food are always placed on the glass tray for cooking.
5. Never restrict the movement of the turtable.
6. If glass tray or turtable ring assembly cracks or breaks, contact your nearest authorized service center.

Countertop Installation

Remove all packing material and accessories. Examine the oven for any damage such as dents or broken door. Do not install if oven is damaged.

1. Select a level surface that provide enough open space for the intake and/or outlet vents.

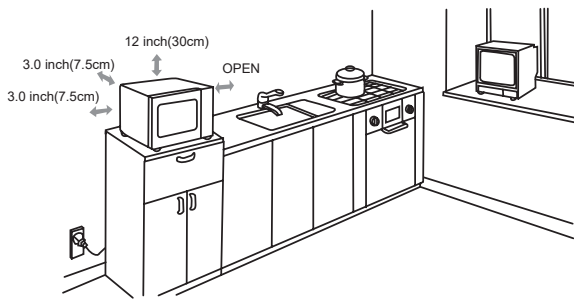

A minimum clearance of 3.0 inches (7.5cm) is required between the oven and any adjacent walls. One side must be open.

- Leave a minimum clearance of 12 inches (30cm) above the oven.
- Do not remove the legs from the bottom of the oven.

Cabinet: Remove any protective film found on the microwave oven cabinet surface. Do not remove the light brown Mica cover that is attached to the oven cavity to protect the magnetron.

- Blocking the intake and/or outlet openings can damage the oven.
 - Place the oven as far away from radios and TV as possible. Operation of microwave oven may cause interference to your radio or TV reception.
2. Plug your oven into a standard household outlet. Be sure the voltage and the frequency is the same as the voltage and the frequency on the rating label.

WARNING - Do not install oven over a range cook-top or other heat-producing appliance. If installed near or over a heat source, the oven could be damaged and the warranty would be void.

The accessible surface may be hot during operation.



CONTROL PANEL

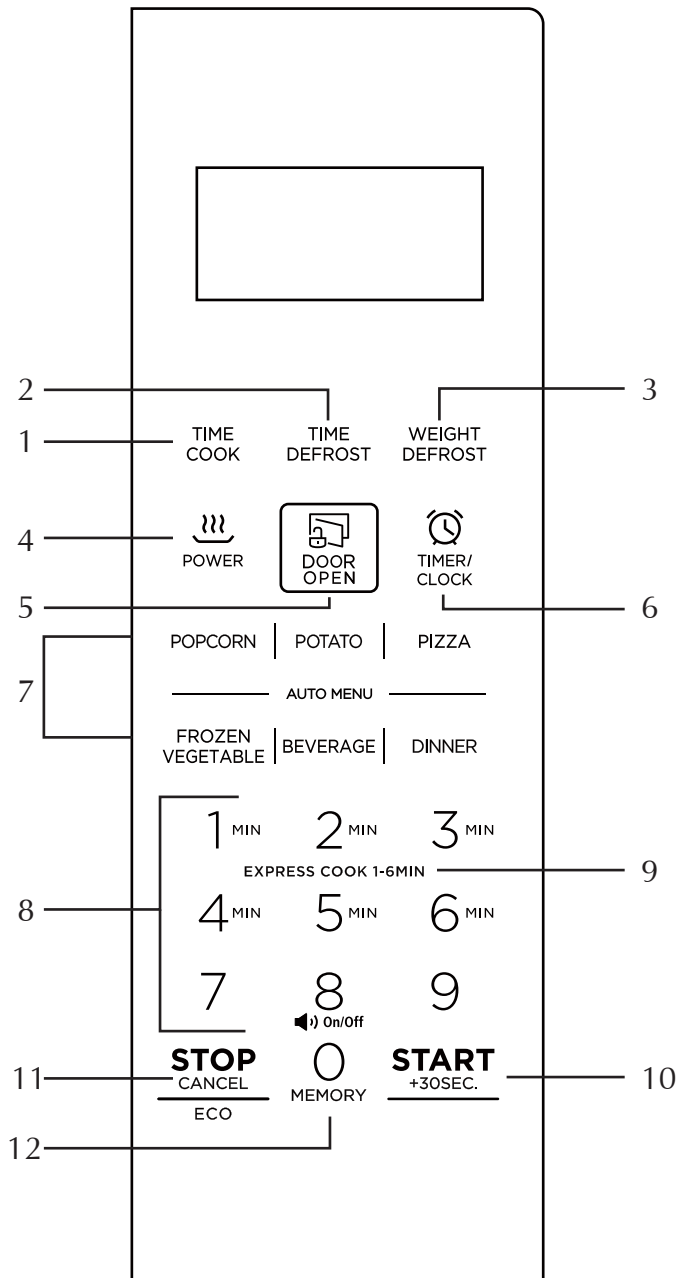

1. Time Cook
2. Time Defrost
3. Weight Defrost
4. Power (10 power levels available)
5. Door Open
6. Timer/Clock
7. Auto Cook Menu (Popcorn, Potato, Pizza, Frozen Vegetable, Beverage, Dinner Plate)
8. Number Pad (0-9)
9. Express Cook (Number Pad 1-6)
10. START/+30 SEC. (Begin cooking time or add time to cooking)
11. Stop/CANCEL (Before cooking starts, press to clear all previous settings; during cooking, press once to stop oven; press twice to stop oven and clear all settings.)
12. Memory function

OPERATION

1. SAFETY LOCK

1. How the safety lock works

Initiating a cooking process triggers the door lock, and it also engages if the door remains unlocked for additional 30 minutes following the completion of the cooking.

Safety Lock is active by default. It will only be deactivated if the user chooses to do so manually. Even in the event of a power disconnection, the oven will preserve the state of the safety lock, whether it is activated or deactivated.

2. Unlock the door

Press  during operation and open the door within 10 seconds,

or the safety lock will re-engage. The door will stay unlocked until cooking is initiated.

Or:

Press  within 30 minutes after cooking is complete to manually disable

the door lock and switch to standby mode. If no key is pressed, the safety lock will automatically disengage after 30 minutes.

3. Deactivate the safety lock

If there are no children in the house, you can choose to permanently deactivate the safety lock function.

Press "7" , "9" in consecutive order and then press and hold  for three seconds within 30 seconds,

the screen will display "ULoc", indicating the successful deactivation of the safety lock.

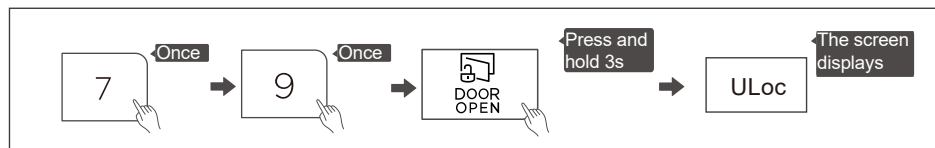



4. Re-activate the safety lock

Press "7" , "9" in consecutive order and then press and hold  for three seconds

within 30 seconds, the screen will display "Loc", indicating the successful re-activation of the safety lock

2. SETTING THE CLOCK

1. Press  twice, the screen will display "00:00".
2. Press the number keys to enter the current time.
For example, time is 12:10 now, please press "1,2,1,0" in turn.
3. Press  to confirm. The clock is set.

NOTE:

- (1) To reset the clock, please repeat step 1 to step 3.
- (2) The clock is a 12-hour display. If the clock is not set, it will not work when powered.

3. SETTING THE KITCHEN TIMER

1. Press  once, the screen will display "00:00".
2. Press the number keys to set the desired time. The maximum time value is "99:99".
3. Press **START**_{+30SEC.} to confirm. The timer starts counting down.



NOTE:

The kitchen timer is a timer.



4. MICROWAVE COOKING

11 power levels are available.

Level	10	9	8	7	6	5	4	3	2	1
Power	100%	90%	80%	70%	60%	50%	40%	30%	20%	10%
Display	PL10	PL9	PL8	PL7	PL6	PL5	PL4	PL3	PL2	PL0

1. Press  once, the screen will display "00:00".
2. Press the number keys to set the cooking time. The maximum time value is "99:99".
3. Press  once, and "PL10" will display. Then press the number keys to set the power level. The 11 power levels are available.
4. Press **START**_{+30SEC.} to start cooking.

Example: To cook the food with 50% microwave power for 15 minutes.

- a. Press  once. "00:00" displays.
- b. Press "1", "5", "0", and "0" in order.
- c. Press  once, then press "5" to select 50% microwave power.
- d. Press **START**_{+30SEC.} to start cooking.

1. Opening the oven door or pressing **STOP**_{CANCEL ECO} during operation will interrupt the current mode.
2. If "PL0" is selected, the oven will work with a fan for no power. You can use this level to remove the odor of the oven.
3. The power level can be changed during operation. Press  once and then the current power will display for 3 seconds. Press the number keys to change the power. The oven will work with the selected power.

5. SPEEDY COOKING

1. In standby mode, pressing the number keys 1 to 6 lets you quickly select a cooking time from 1 to 6 minutes. Then you can press **START**_{+30SEC.} to increase the cooking time. The maximum time value is "99:99".
2. In standby mode, press **START**_{+30SEC.} to cook food at 100% power level for 30 seconds. Each press on the same key can increase 30 seconds and the maximum time value is "99:99".

NOTE:

In the cooking state and defrosting by time state, each more press on **START**_{+30SEC.} can increase the cooking time by 30 seconds (except for defrosting by weight, the auto menu, and the first stage of multi-stage cooking).

6. DEFROST BY WEIGHT

1. Press **WEIGHT**_{DEFROST} once, "dEF1" will display.
2. Press the number keys to set the weight of the food. The range of weight is 4 to 100 Oz.
3. Press **START**_{+30SEC.} to start defrosting.

NOTE:

The buzzer will sound to remind you to turn the food over during defrosting. If no operation, the oven will continue working.

7. DEFROST BY TIME

1. Press **TIME**_{DEFROST} once and then the screen will display "dEF2".
2. Press the number keys to set the desired defrost time. The maximum time value is "99:99".
3. Press **POWER** once, "PL3" will display. And then press the number keys to set the power level. (If you do not need to set the power level, skip this step.)
4. Press **START**_{+30SEC.} to start defrosting.

NOTE:





The defrost power cannot be changed during defrosting.

8. MULTI-STAGE COOKING

NOTE:

1. Two cooking stages can be set in multi-stage cooking.
2. If you set the defrost function, it will work automatically in the first stage.
3. The auto menu cannot be set as one of the multi-stage.

Example: Defrost food for 5 minutes and then cook with 80% microwave power for 7 minutes

1. Press  once and then the screen will display "dEF2".
2. Press "5", "0", and "0" to set the desired defrost time to 5 minutes
3. Press  once and then press "7", "0", and "0" to set the cooking time.
4. Press  once and then "PL10" will display.
5. Press "8" to set the power level to PL8.
6. Press  to start cooking.

9. AUTO MENU

1. Press the corresponding menu key repeatedly to select the weight of the food you want.
Example: Press **PIZZA** once and then "4.0 -" displays.
2. Press  to start cooking.

FARBERWARE®

AUTO MENU CHART

Menu	Weight	Display	Power
POPCORN	1.75Oz	1.75	PL10
	3.2Oz	3.2 ⁻	
	3.5Oz	3.5 ⁻	
POTATO	1 (8Oz)	1	PL10
	2 (16Oz)	2	
	3 (24Oz)	3	
PIZZA	4.0Oz	4.0 ⁻	PL8
	8.0Oz	8.0 ⁻	
	14.0Oz	14.0 ⁻	
FROZEN VEGETABLE	4.0Oz	4.0 ⁻	PL10
	8.0Oz	8.0 ⁻	
	16.0Oz	16.0 ⁻	
BEVERAGE	1 Cup (120ml)	1-	PL10
	2 Cups (240ml)	2-	
	3 Cups (360ml)	3-	
DINNER	9.0Oz	9.0 ⁻	PL10
	12.0Oz	12.0 ⁻	
	18.0Oz	18.0 ⁻	

10. MEMORY FUNCTION

You can save the settings for a dish in the memory and call it up again.

1. Press  repeatedly to select the memory 1-3 procedure.





"1", "2" and "3" will display in order.

2. If the procedure has been set, press  to start working.

Otherwise, please continue to set.

3. After finishing the setting, press  once to save the procedure.

Example: Set memory 2 (cook food with 80% microwave power for 3 minutes).

1. In standby mode, press  twice.
2. Press  once and then press the number keys "3", "0", and "0" in order.
3. Press  once and then press the number key "8".
4. Press  to save the setting and "2" will display.

NOTE:

The defrost power cannot be changed during defrosting.

1. If the power is not cut off, the procedure will be saved all the time.
2. The auto menu, the speedy cooking, and the kitchen timer cannot be set as a memory function.

11. INQUIRING FUNCTION

1. If the clock has been set, the current time will display for three seconds by pressing





in the cooking state.

2. In the microwave cooking state, press  to inquire about the power level.

It will display for three seconds.

12. LOCK FUNCTION FOR CHILDREN

To activate the lock:

In standby mode, press and hold  for three seconds. A beep sounds and "  " will display.

To deactivate the lock:

In a locked state, press and hold  for three seconds. A beep sounds.

13. ECO FUNCTION

To enter ECO mode:

In standby mode, and the oven door is closed, press  once. The screen will turn off.

To cancel ECO mode:

In ECO mode, pressing any key, or opening the door will cancel it.

14. MUTE MODE

To activate the mute mode:

In standby mode, press and hold  for 3 seconds. A beep will sound and “OFF” will display. When you press the key, it does not make a sound.

To deactivate the mute mode:

In mute mode, press and hold  for 3 seconds. A beep will sound and “On” will display.

MAINTENANCE

Troubleshooting

Check your problem by using the chart below and try the solutions for each problem. If the microwave oven still does not work properly, contact the nearest authorized service center.

Trouble	Possible Cause	Possible Remedy
Oven will not start	<ul style="list-style-type: none"> a. Electrical cord for oven is not plugged in. b. Door is open. c. Wrong operation is set. 	<ul style="list-style-type: none"> a. Plug into the outlet. b. Close the door and try again. c. Check instructions.
Arcing or sparking	<ul style="list-style-type: none"> a. Materials to be avoided in microwave oven were used. b. The oven is operated when empty. c. Spilled food remains in the cavity. 	<ul style="list-style-type: none"> a. Use microwave-safe cookware only. b. Do not operate with oven empty. c. Clean cavity with wet towel.
Unevenly cooked foods	<ul style="list-style-type: none"> a. Materials to be avoided in microwave oven were used. b. Food is not defrosted completely. c. Cooking time, power level is not suitable. d. Food is not turned or stirred. 	<ul style="list-style-type: none"> a. Use microwave-safe cookware only. b. Completely defrost food. c. Use correct cooking time, power level. d. Turn or stir food.
Overcooked foods	Cooking time, power level is not suitable.	Use correct cooking time, power level.
Undercooked foods	<ul style="list-style-type: none"> a. Materials to be avoided in microwave oven were used. b. Food is not defrosted completely. c. Oven ventilation ports are restricted. d. Cooking time, power level is not suitable. 	<ul style="list-style-type: none"> a. Use microwave-safe cookware only. b. Completely defrost food. c. Check to see that oven ventilation ports are not restricted. d. Use correct cooking time, power level.
Improper defrosting	<ul style="list-style-type: none"> a. Materials to be avoided in microwave oven were used. b. Cooking time, power level is not suitable. c. Food is not turned or stirred. 	<ul style="list-style-type: none"> a. Use microwave-safe cookware only. b. Use correct cooking time, power level. c. Turn or stir food.

FARBERWARE®

ONE YEAR LIMITED WARRANTY

This warranty applies to products purchased and used in the U.S and Canada.

This is the only express warranty for this product and is in lieu of any other warranty or condition.

This product is warranted to be free from defects in material and workmanship for a period of one (1) year from the date of original purchase. This warranty is valid for the original retail purchaser or gift recipient from the date of initial retail purchase and is not transferable. Keep your original sales receipt as proof of purchase is required to make a warranty claim.

IMPORTANT: This warranty does not cover damages resulting from use not in conformity with the printed directions, accident, misuse or abuse, alternation, the affixing of any attachments not provided with the product, loss of parts, or subjecting the appliance to any but the specified voltage. (Read directions carefully.) This warranty is void if the product is used for other than single-family household use or subjected to any voltage and waveform other than as specified on the rating label (e.g., 120V ~ 60 Hz).

Englewood Marketing LLC excludes all claims for special, incidental, and consequential damages caused by breach of express or implied warranty. All liability is limited to the amount of the purchase price. **Every implied warranty, including any statutory warranty or condition of merchantability or fitness for a particular purpose, is disclaimed except to the extent prohibited by law, in which case such warranty or condition is limited to the duration of this written warranty.** This warranty gives you specific legal rights. You may have other legal rights that vary depending on where you live. Some states or provinces do not allow limitations on implied warranties or special, incidental, or consequential damages, so the foregoing limitations may not apply to you.

To make a warranty claim or if service is required, please call our CUSTOMER SERVICE NUMBER.

Product registration is not mandatory. Failure to complete and return the card or form does not diminish the consumer's warranty rights.

For faster service, please have the model, type, and series numbers ready for the operator to assist you.

Customer Service Number
Englewood Marketing LLC
In the US 844-918-0509

Email: CustomerService@emllc-USA.com