



















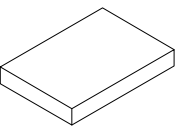

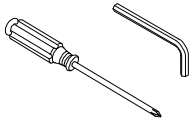
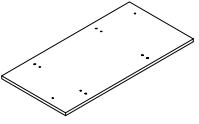
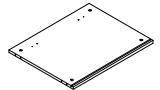
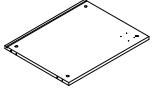

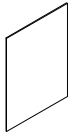
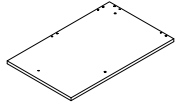
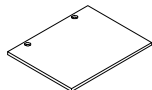
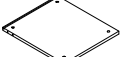
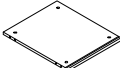

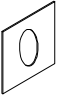
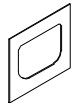
## Hardware List

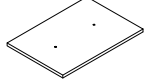
<b>A</b>  20PCS (M6*40)	<b>B</b>  18PCS (M8*40)	<b>C</b>  20PCS (ø12*15)	<b>D</b>  20PCS	<b>E</b>  4PCS
<b>F</b>  8PCS (M8*50)	<b>G</b>  16PCS (M4*12)	<b>H</b>  1PC (M8*50)	<b>I</b>  2PCS	<b>J</b>  1PC
<b>K</b>  1PC	<b>L</b>  1PC	<b>M</b>  2PC	<b>N</b>  1PC	 1PC

## Panel List

<b>1</b>  1PC	<b>2</b>  1PC	<b>3</b>  1PC	<b>4</b>  1PC	<b>5</b>  1PC
<b>6</b>  1PC	<b>7</b>  1PC	<b>8</b>  1PC	<b>9</b>  1PC	<b>10</b>  1PC
<b>11</b>  1PC	<b>12</b>  1PC	<b>13</b>  1PC	<b>14</b>  1PC	<b>15</b>  1PC
<b>16</b>  1PC	<b>17</b>  3PCS	<b>18</b>  1PC	<b>19</b>  2PCS	<b>20</b>  1PC

## Assembling the unit with camlocks and wood dowels

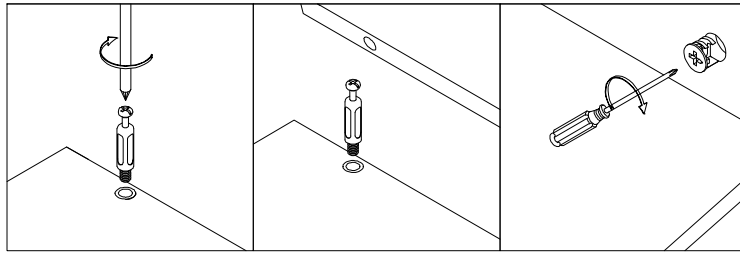

## Assembly instructions

step 1

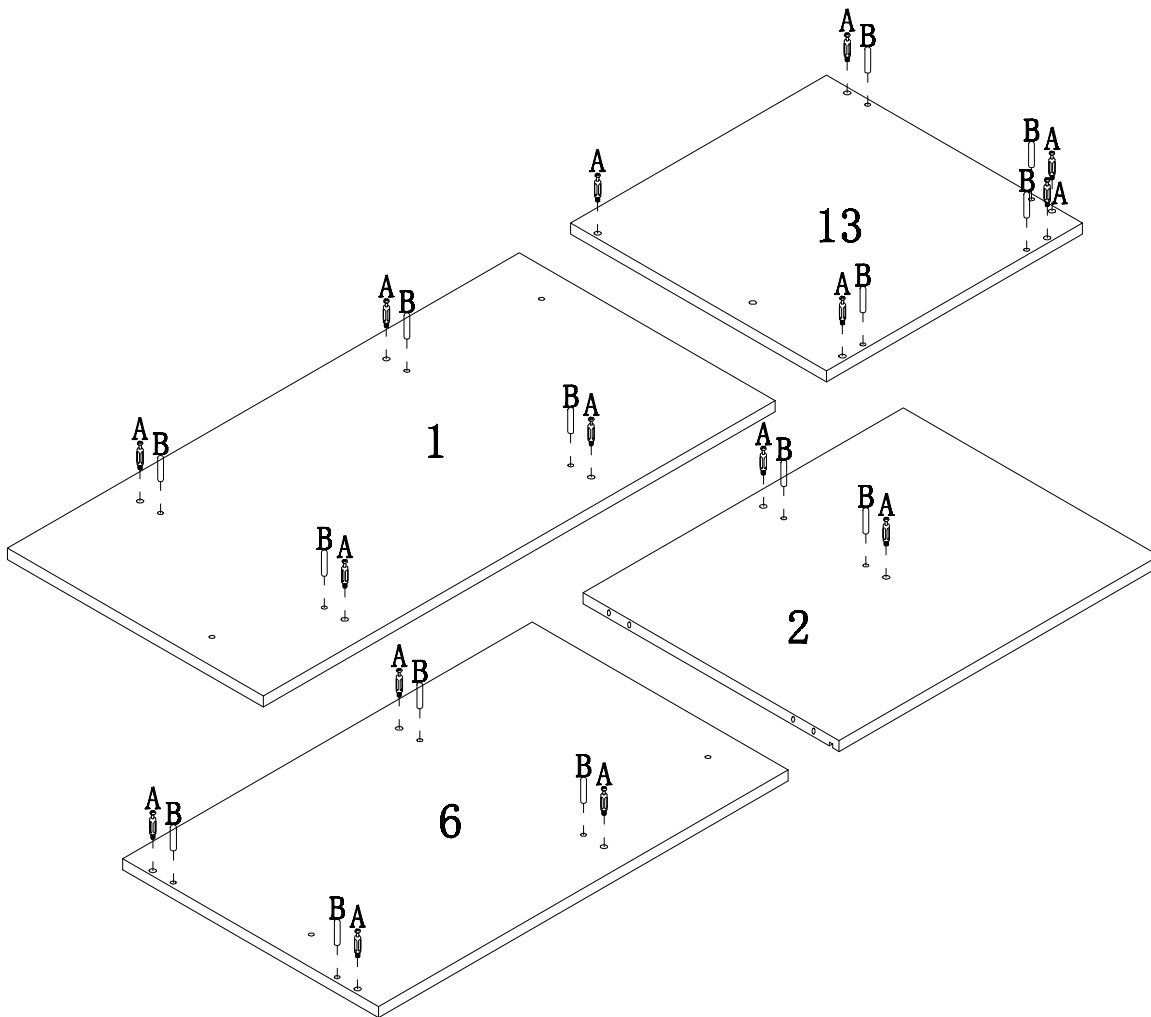
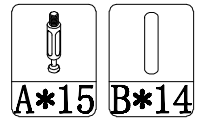

step 2

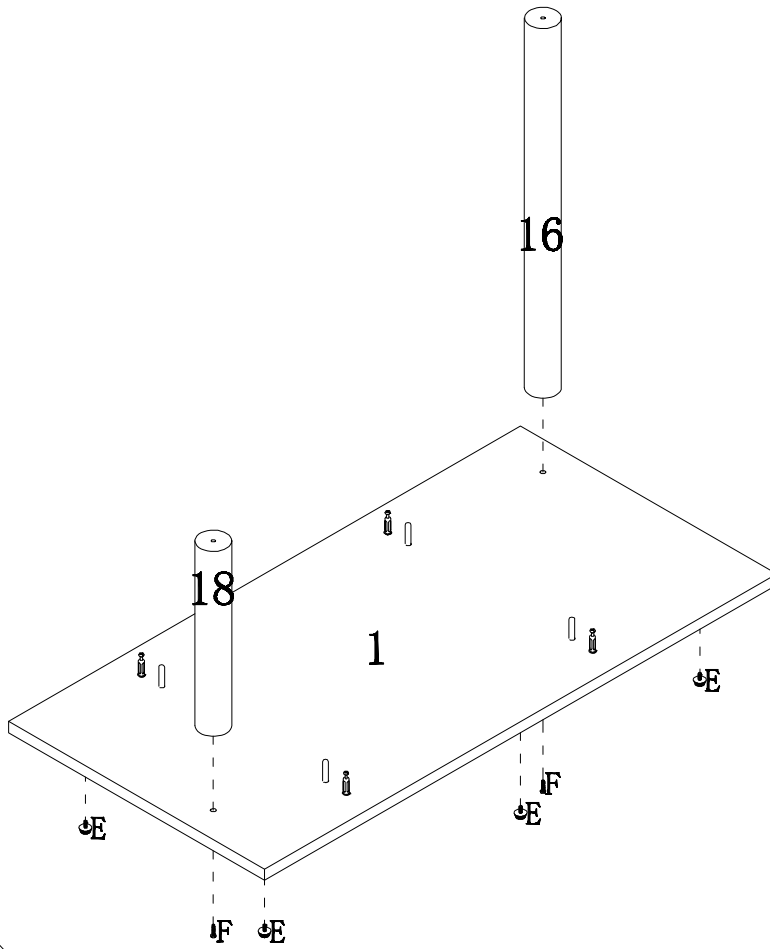
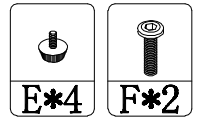

step 3

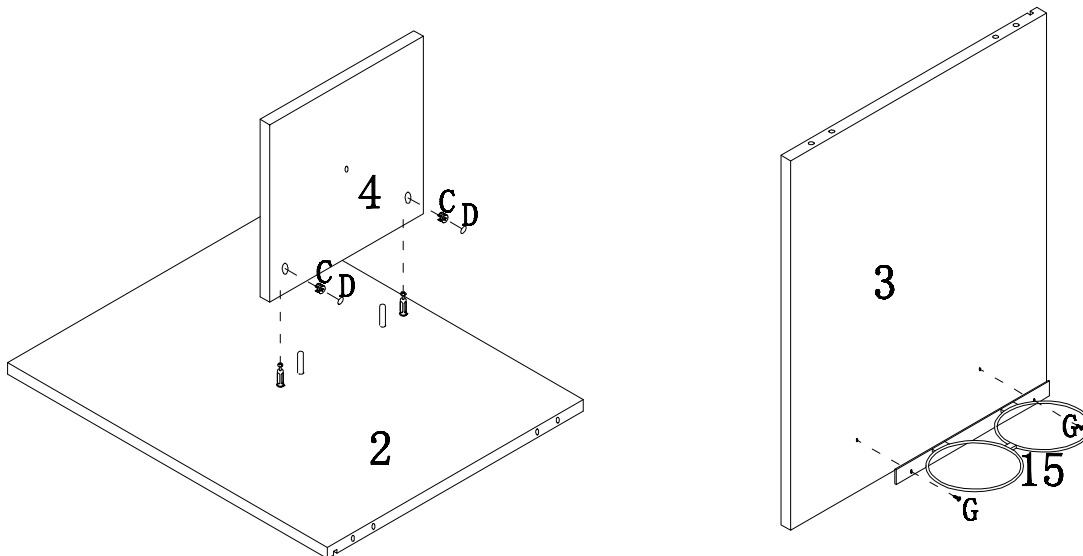
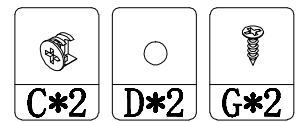

step 4

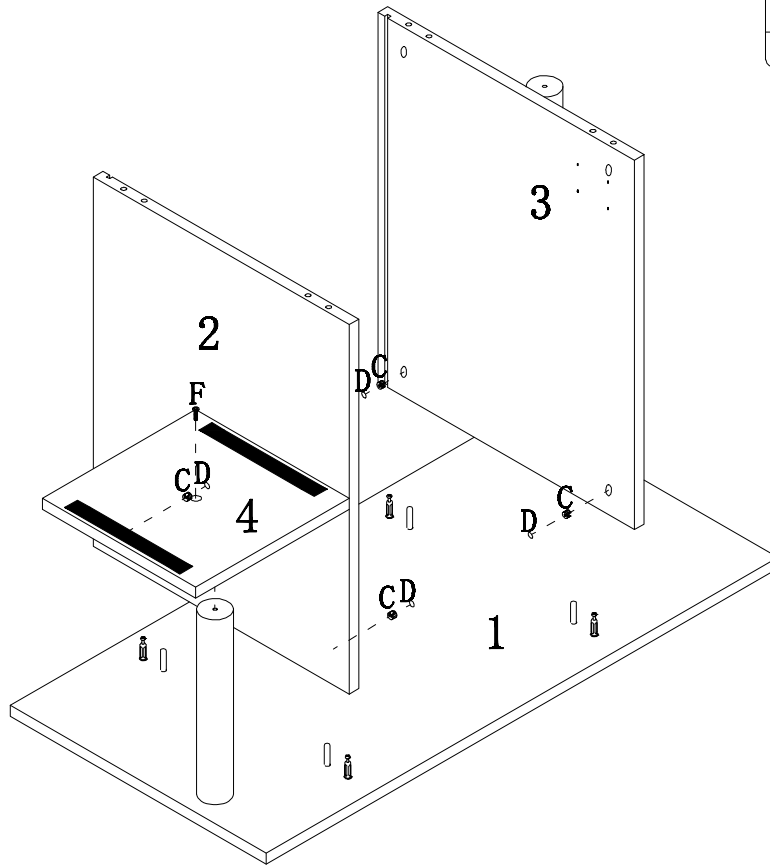
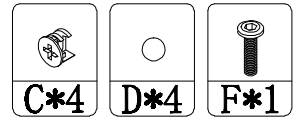

step 5

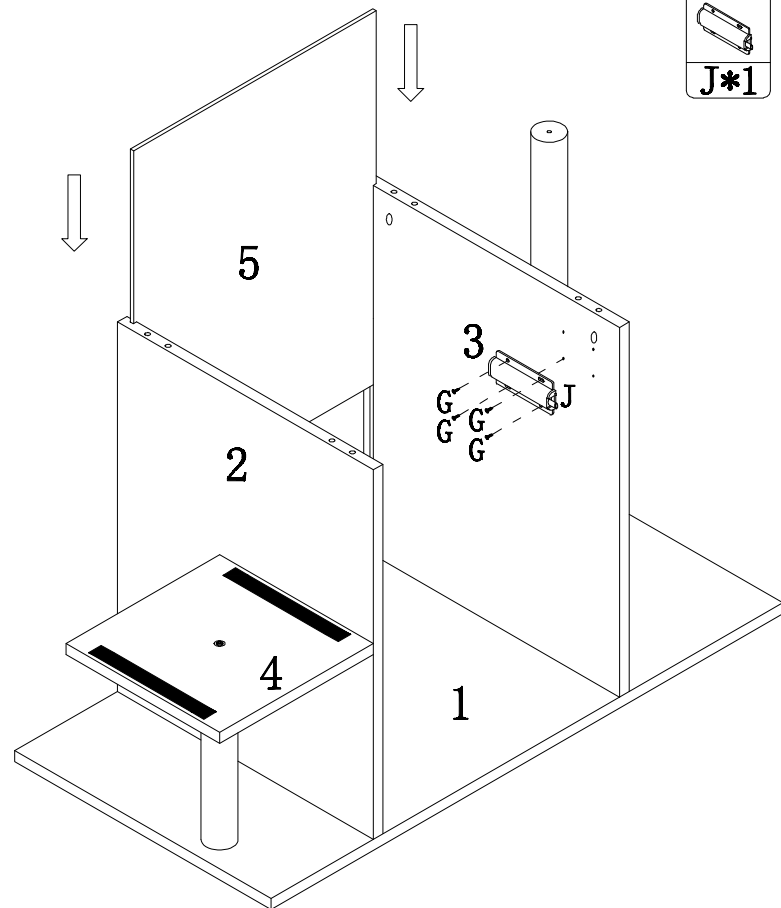
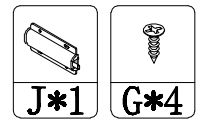

step 6

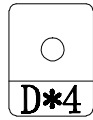
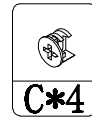
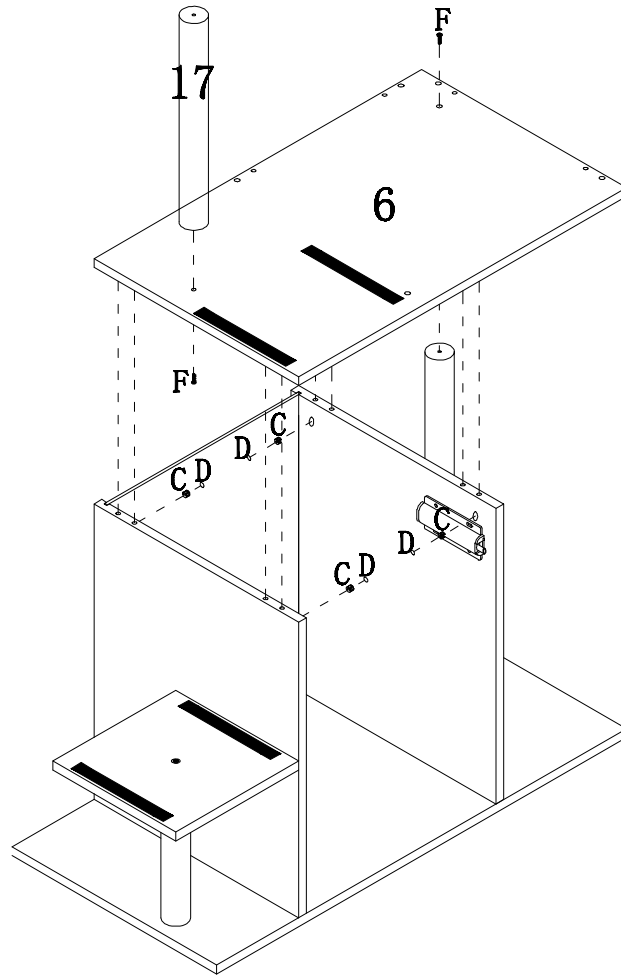

step 7

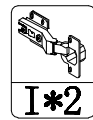
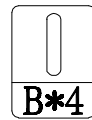
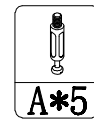
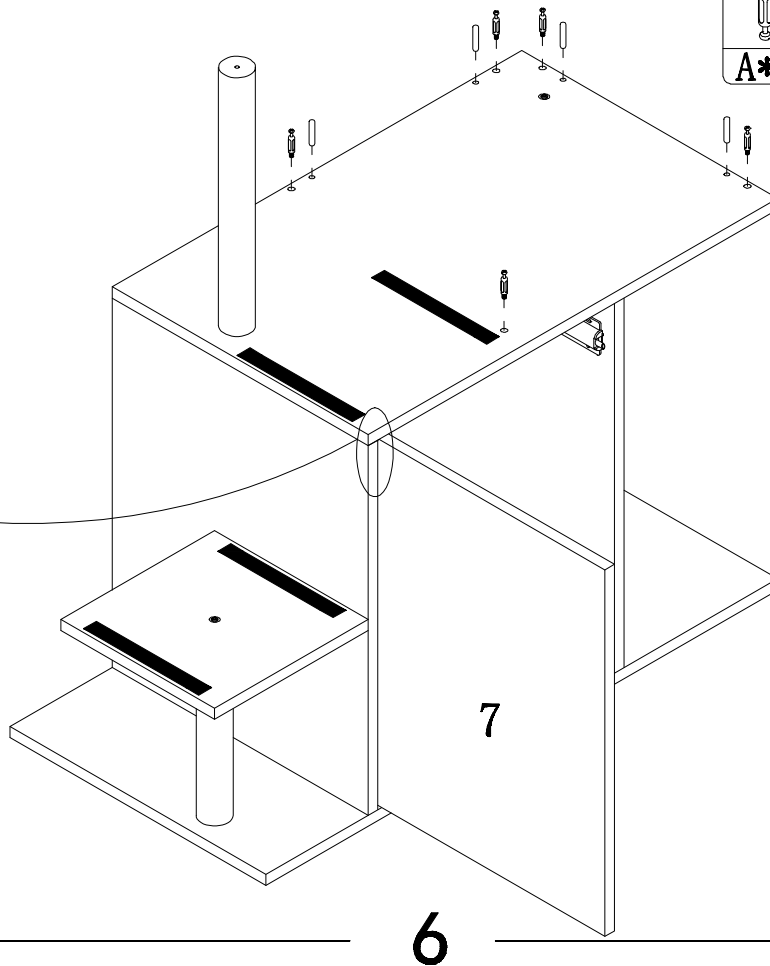
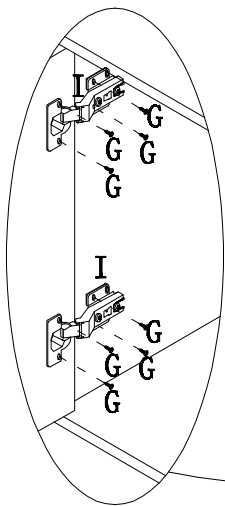

step 8

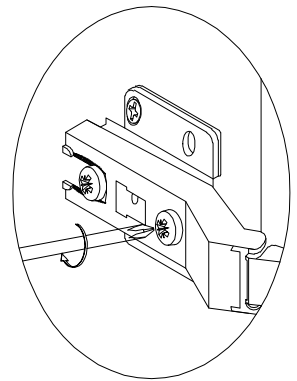
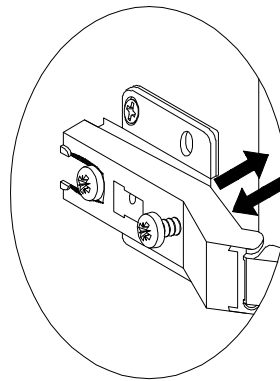
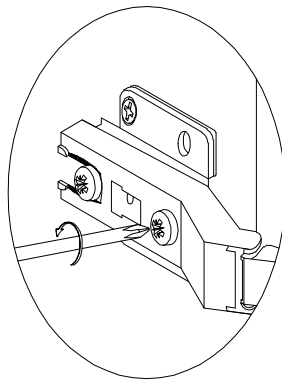
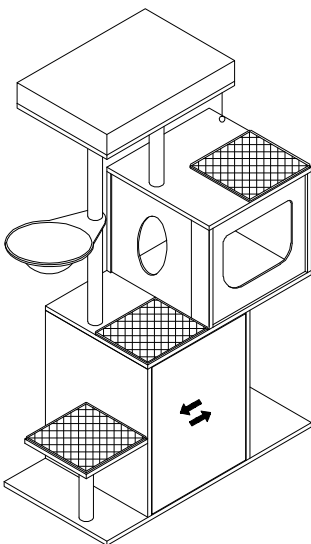
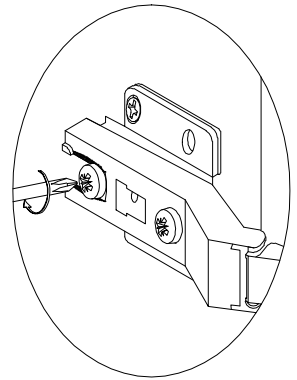
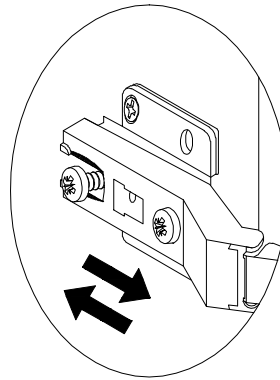
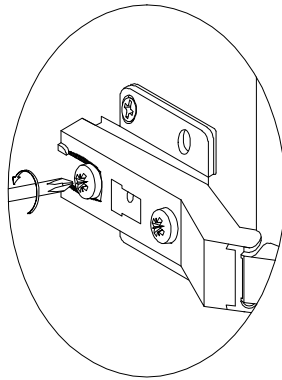
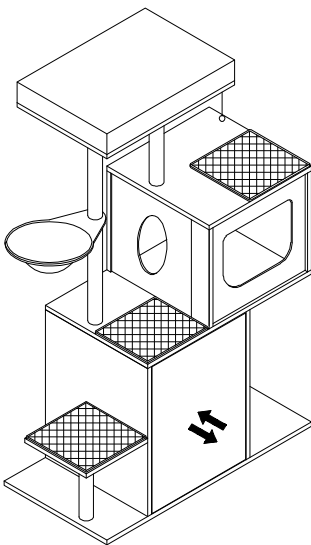
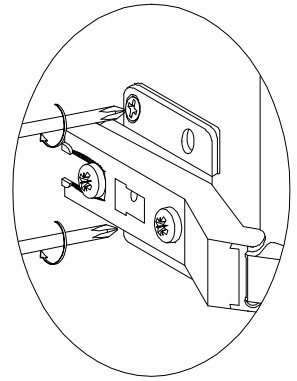
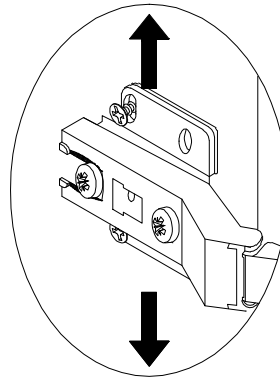
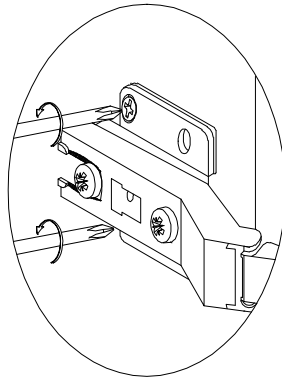
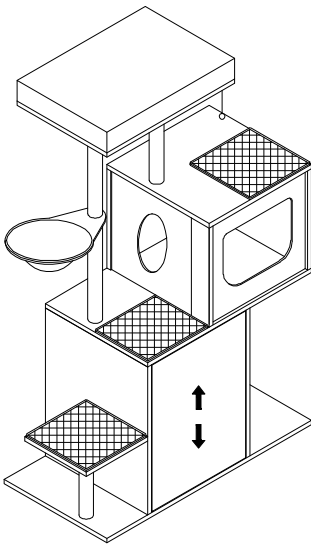

step 9

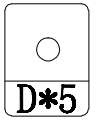
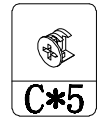
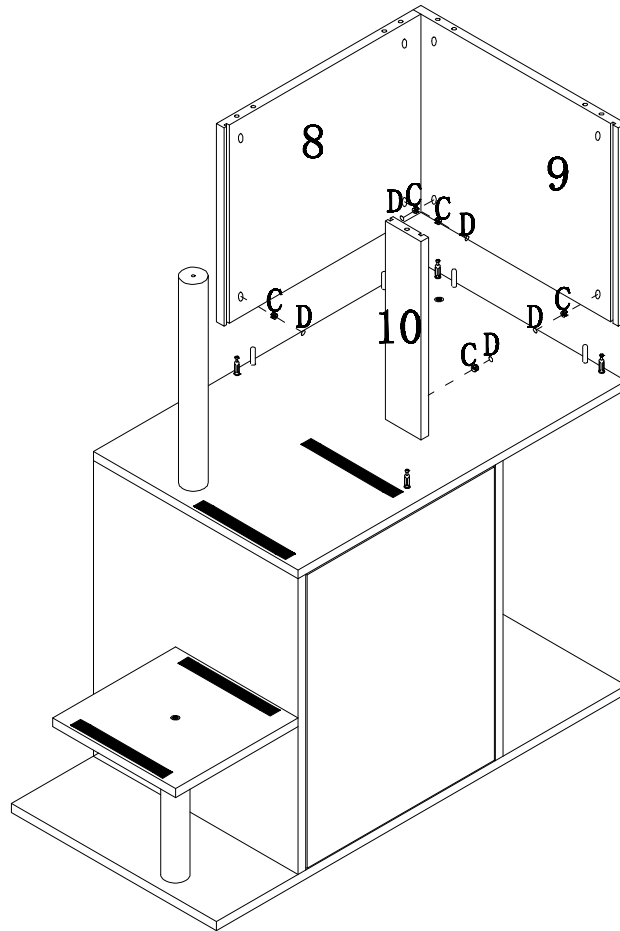

step 10

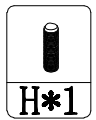
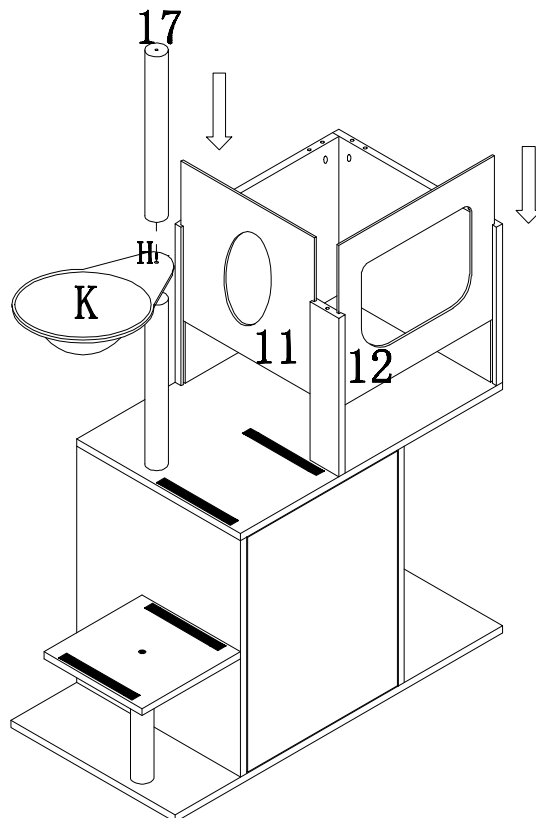

step 11

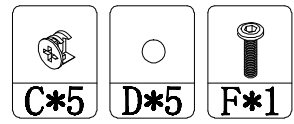
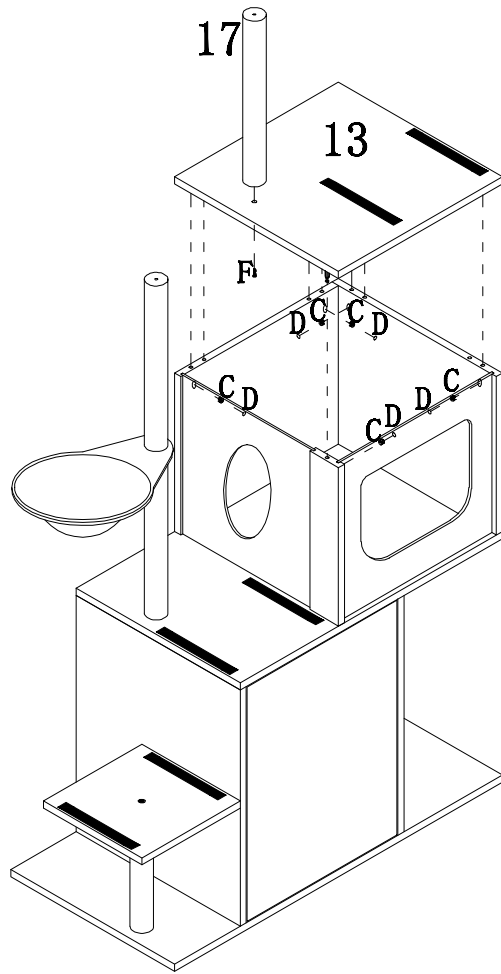

step 12

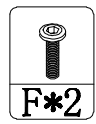
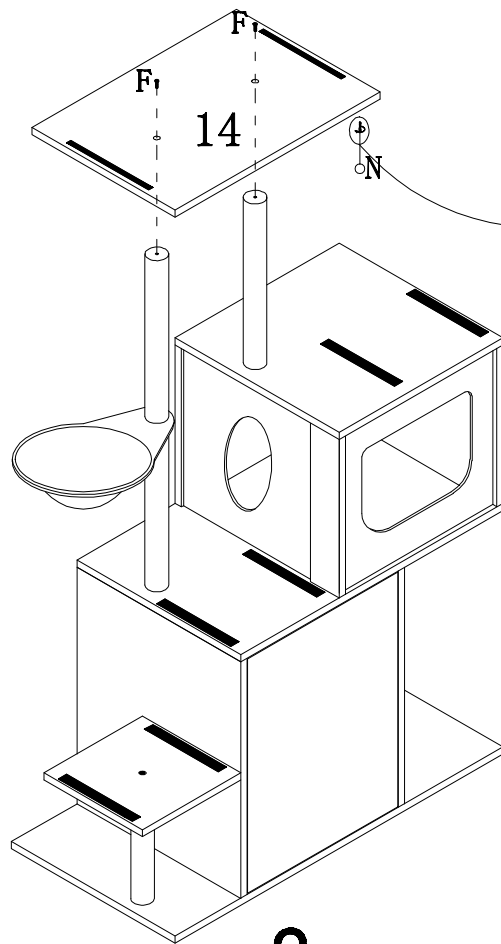

step 13

