

# Assembly Instructions

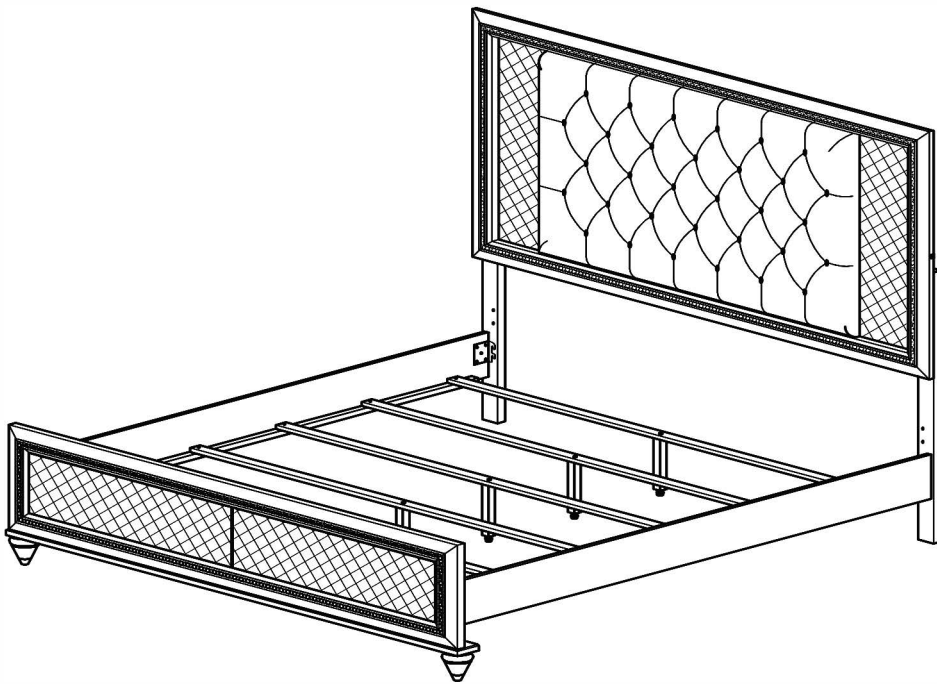

## ASSEMBLY RATING

The Assembly Rating is a 5-point system that shows the degree of effort needed in assembling a specific product (with 1 being easy and 5 being difficult). For some products, two persons are recommended.

EASY



DIFFICULT

## Tools Required For Assembly:

Allen Wrench

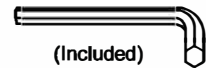

(Included)

Phillips Screwdriver

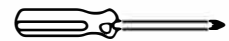

(Not Included)



2 PERSONS RECOMMENDED

# ASSEMBLY & CARE ADVICE

FOR YOUR FURNITURE TO LAST, CORRECT ASSEMBLY AND PROPER MAINTENANCE ARE NECESSARY. PLEASE FOLLOW THE INFORMATION PROVIDED BELOW TO FULLY ENJOY YOUR FURNITURE.

## BASIC ASSEMBLY TECHNIQUES

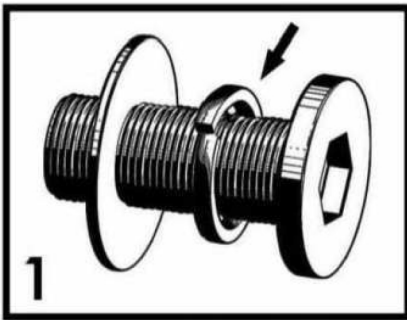

When lock or spring washer is used in an assembly, please make sure the lock or spring washer is placed between the larger flat washer and the head of the screw or bolt.

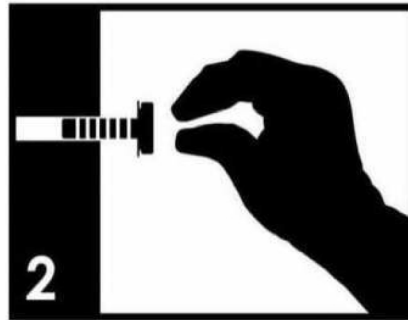

Position each part correctly and insert screws or bolts into their respective holes by hand tighten or using the proper hand tool. Only tighten when step is completed or when instructed to do so.

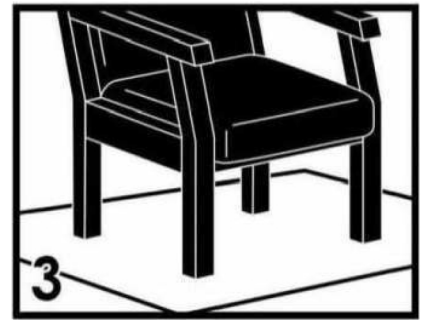

Use cardboard or carpet area when assembling furniture to prevent scratches. Make sure the furniture rests on a flat and level surface with each leg evenly touching the floor. No dragging of products/parts.

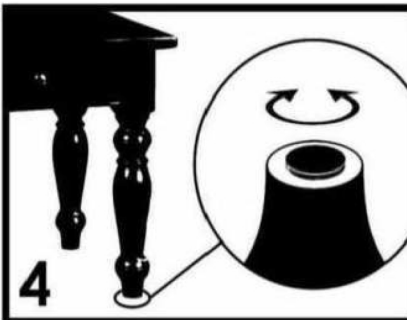

Some furniture comes with height adjustment knobs underneath each leg. To lower or to raise each leg, you need to turn clockwise or counterclockwise, respectively.

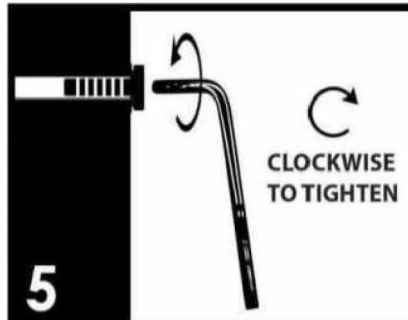

Make sure all parts are properly aligned, then use the appropriate hand tool to completely tighten the bolts or screws. Do not use power tools and do not overtighten.

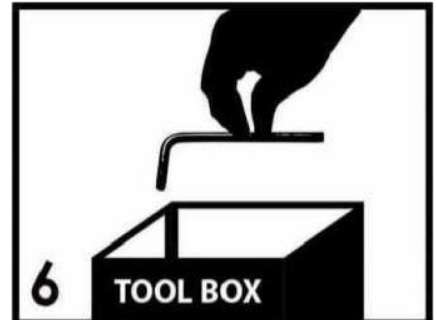

Save the instructions and store the Allen wrench or any supplied tool for later maintenance. After two weeks, check and tighten any loose hardware and repeat again every six months thereafter.

IT IS THE USER'S RESPONSIBILITY TO MAINTAIN THE FURNITURE. THE HARDWARE MAY LOOSEN OVER TIME AND MAY CAUSE THE FURNITURE TO BE WOBBLY AND UNABLE TO SUPPORT ITS INTENDED WEIGHT CAPACITY. THIS MAY LEAD TO COLLAPSE AND MAY CAUSE SERIOUS INJURY.



**FAILURE TO FOLLOW THE GUIDELINES ABOVE MAY RESULT IN INJURY AND/OR PROPERTY DAMAGE.**



Before you begin, please read Page 2 of "Assembly and Care Advice".

And remember, do not tighten until each step is completed or instructed.

### Parts List

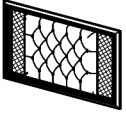

#1 x 1pc  
Headboard ( LED)

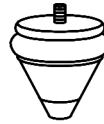

#5 x 2pcs  
Bun Foot

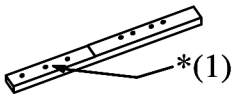

#2 x 1pc  
Headboard Leg (L)



#6 x 2pcs  
Side Rail

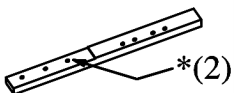

#3 x 1pc  
Headboard Leg (R)

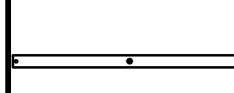

#7 x 5pcs  
Slat

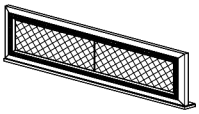

#4 x 1pc  
Footboard

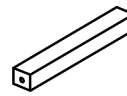

#8 x 5pcs  
Slat Support Leg

### Hardware Pack in Headboard



#A x 1pc  
Allen Wrench

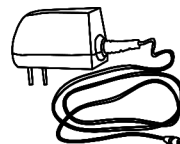

#E x 1pc  
AC Adapter



#B x 6pcs  
JCBC 35mm



#C x 6pcs  
M6 Lock Washer



#D x 6pcs  
M6 Flat Washer

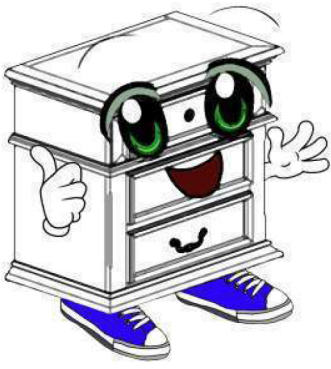

Before you begin, please read Page 2 of "Assembly and Care Advice".

And remember, do not tighten until each step is completed or instructed.

### Hardware Pack in Side Rail

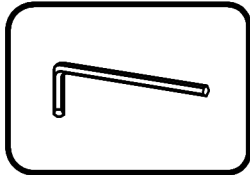

#F x 1pc  
Allen Wrench

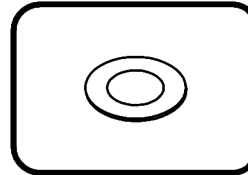

#I x 8pcs  
M8 Flat Washer

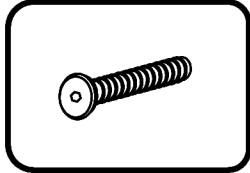

#G x 8pcs  
JCBC 5/16" x 20mm

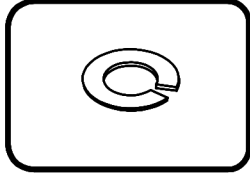

#H x 8pcs  
M8 Lock Washer

### Hardware Pack in Footboard

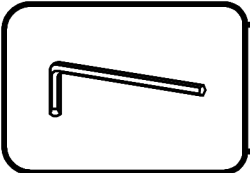

#J x 1pc  
Allen Wrench

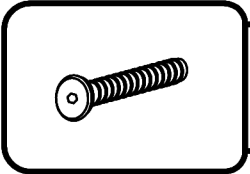

#K 5pcs  
JCBC 35mm

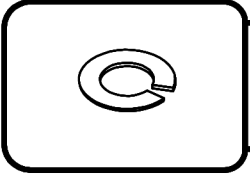

#L x 5pcs  
M6 Lock Washer

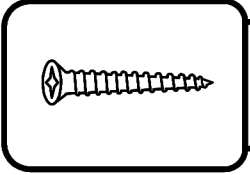

#M x 10pcs  
Screw 32mm

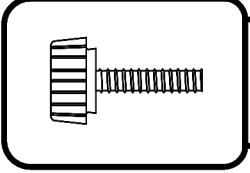

#N x 5pcs  
Adjustable Leveler



- #B x 6pcs
- #C x 6pcs
- #D x 6pcs
- #E x 1pc



Ensure adapter socket connect to behind Headboard socket

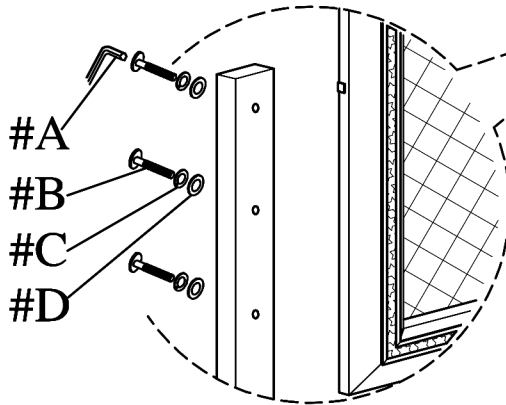

#1

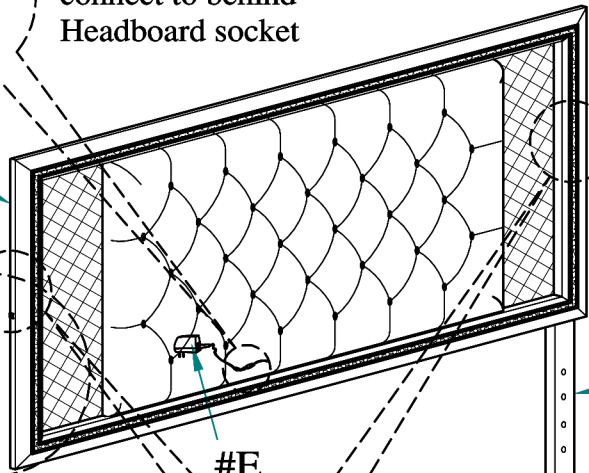

R2

#3

#E

L1

#2

Lighting touch switch (Left & Right)

Prepare 6 bolts assembly by inserting lock washer (#C), then flat washer (#D) onto bolts (#B). Align left HB leg (#2) and right HB leg (#3) to the holes of the headboard (#1) as shown in the diagram. Secure by using bolts (#B).



Remove Bun Foot from the carton

Remove Bun Foot cover

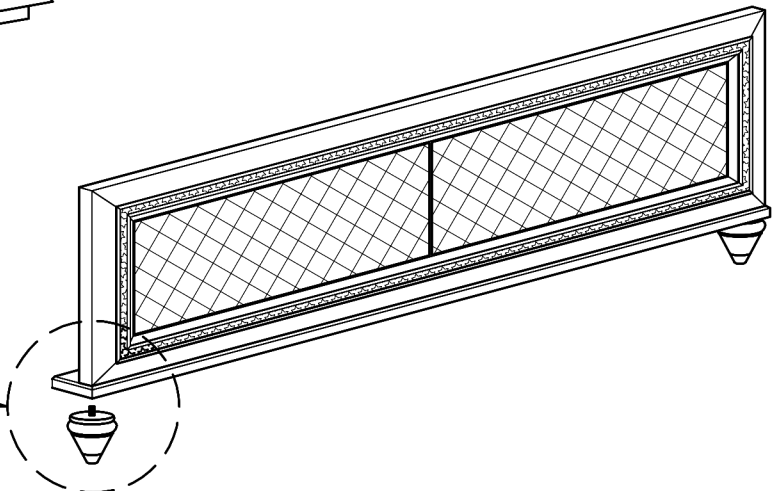
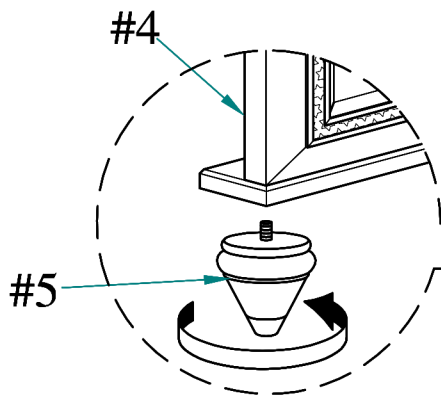
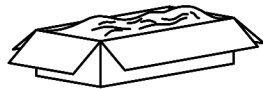

Secure the (#5) Bun Foot to the bottom of (#4) Foot Board as a diagram shown.



Prepare 8 bolts assembly by inserting lock washer (#H), then flat washer (#I) onto bolts (#G). Secure the half of bolts to the HB Leg & Footboard, align and hook side rails (#6) to the bolts of the headboard (#1) and footboard (#4) as shown in the diagram. Tighten all bolt & make sure it is firmly secured.

#G x 8pcs  
#H x 8pcs  
#I x 8pcs

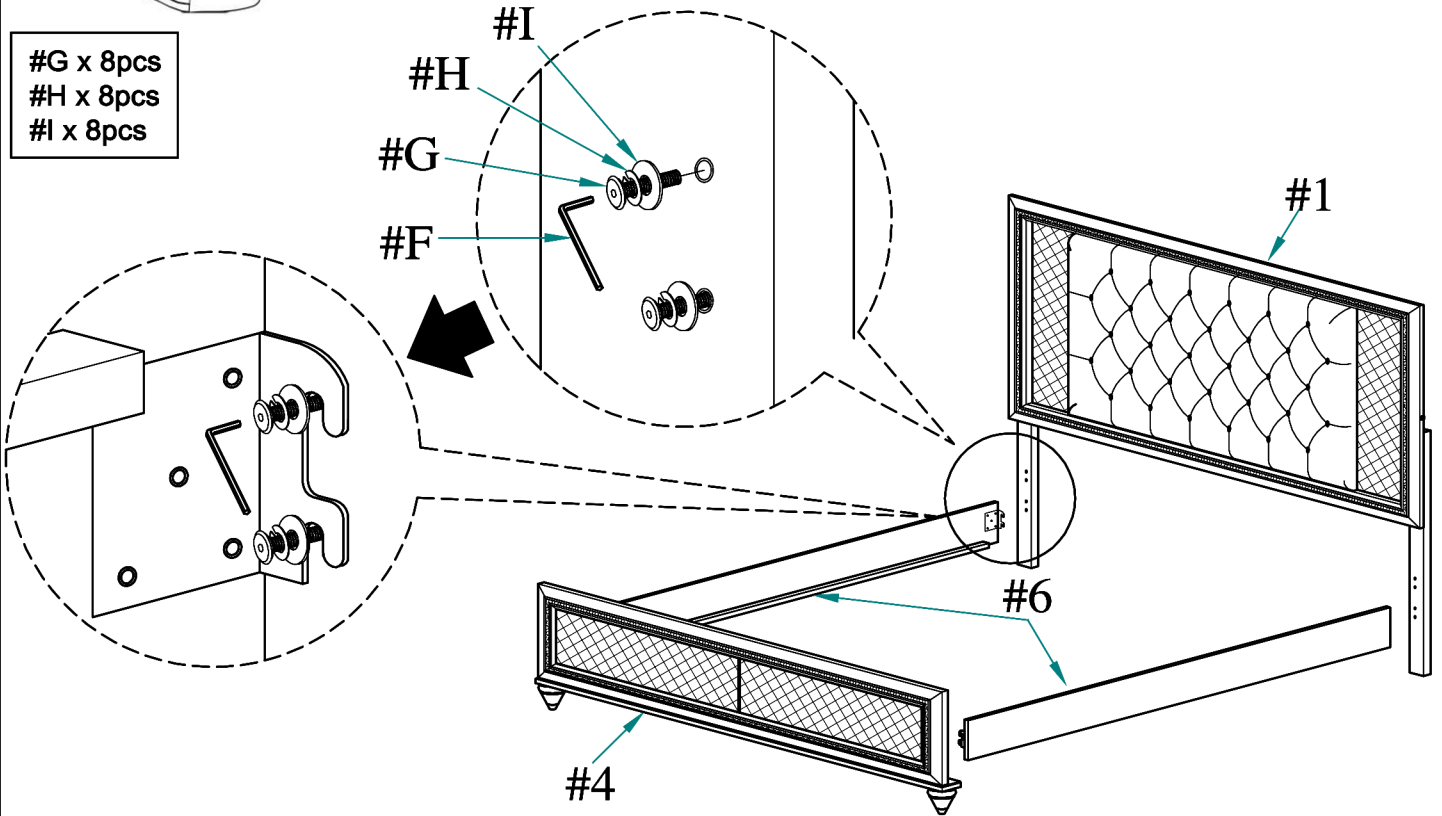

#K x 5pcs  
#L x 5pcs  
#M x 10pcs  
#N x 5pcs

Prepare 5 bolts assembly by inserting lock washer (#L) onto bolts (#K). Attach levelers (#N) onto the support legs (#8) and adjust leveler according to ground level. Then secure by using bolts (#K).

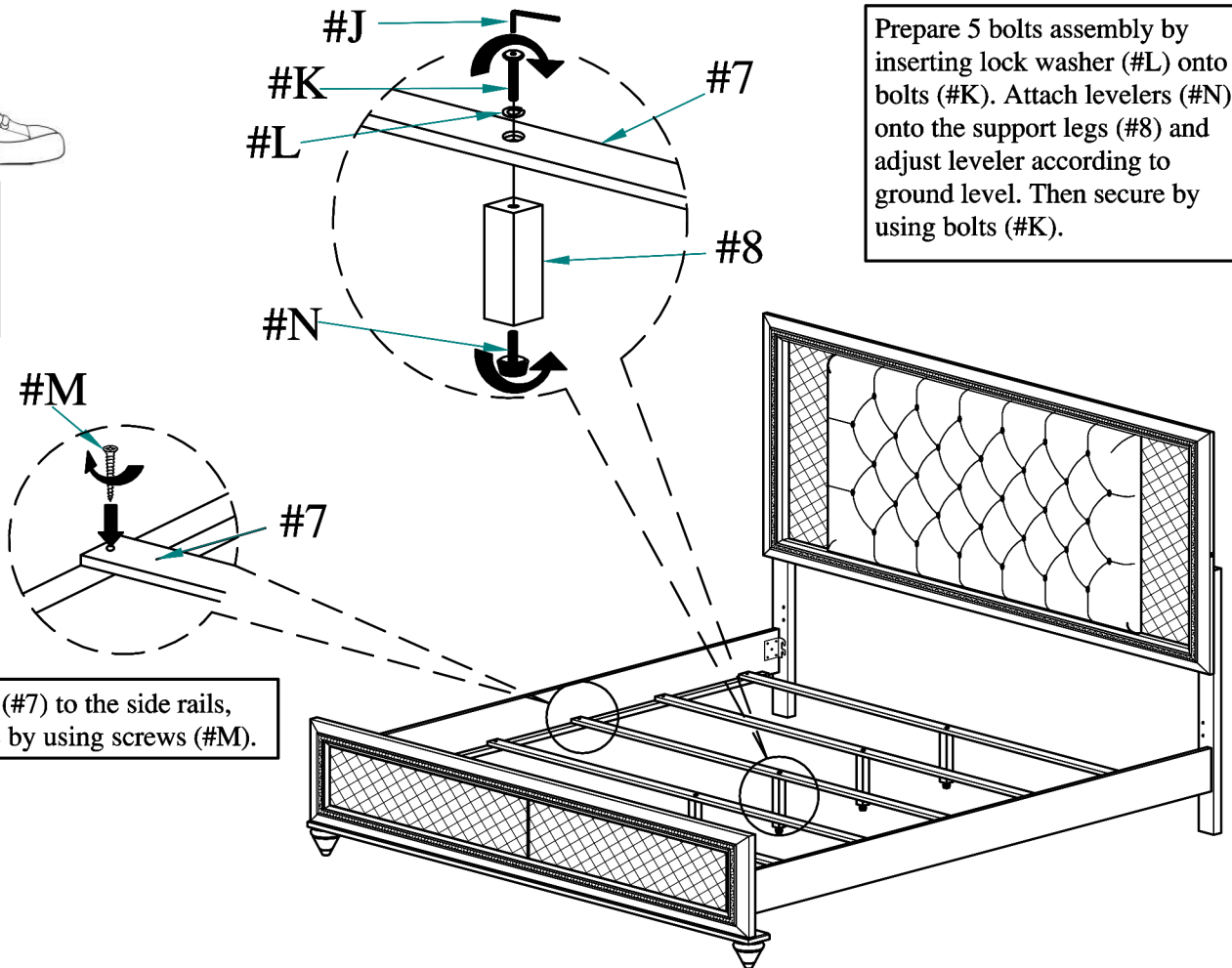

Align slats (#7) to the side rails, then secure by using screws (#M).

