

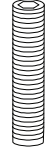
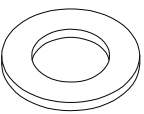
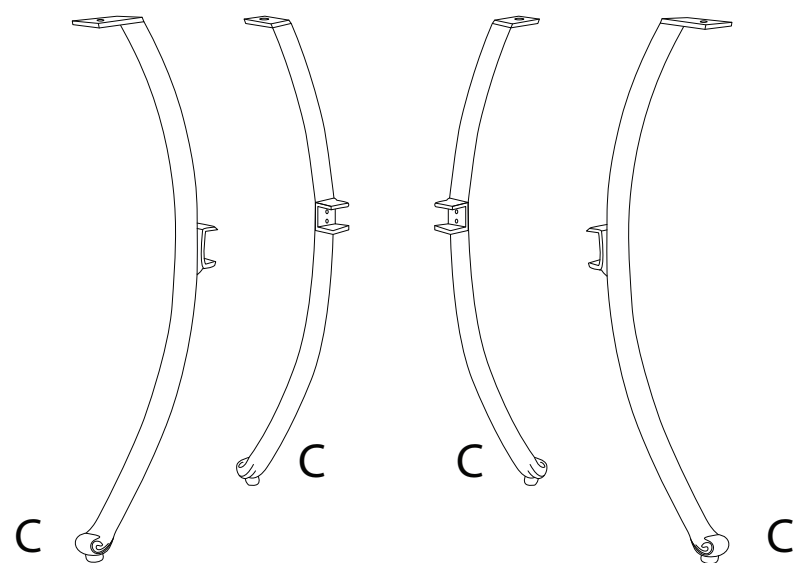
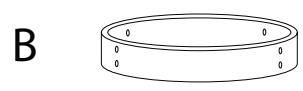
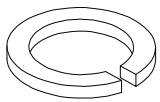
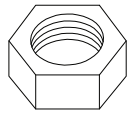

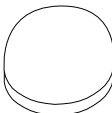
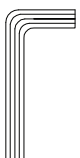
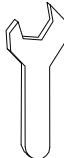

Diagram illustrating assembly instructions and safety warnings:









- Top Section:** Shows a warning triangle (exclamation mark) next to a box containing icons for an Allen key, a wrench, and a power drill with a slash through it, indicating that a power drill should not be used. To the right is a clock icon with the text "15'", indicating a 15-minute assembly time.
- Bottom Section:** Shows a warning triangle (exclamation mark) next to a box containing icons for a rectangular block being placed on a surface and a block being lifted, indicating a lifting or placement instruction. To the right is a person icon with the text "1", indicating that one person is required for assembly.

<b>A</b>	<b>B</b>	<b>C</b>	<b>D</b>	<b>E</b>
				
<b>x 1</b>	<b>x 1</b>	<b>x 4</b>	<b>x 4</b>	<b>x 12</b>

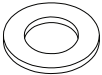
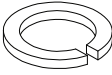

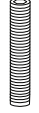



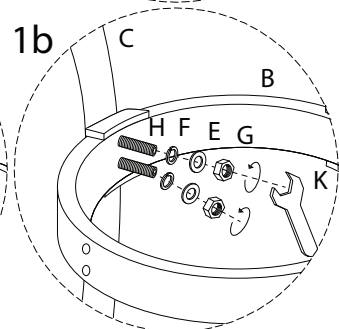
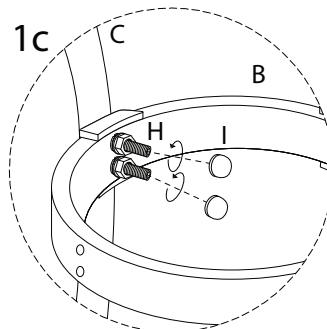
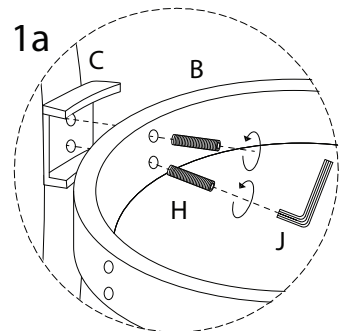
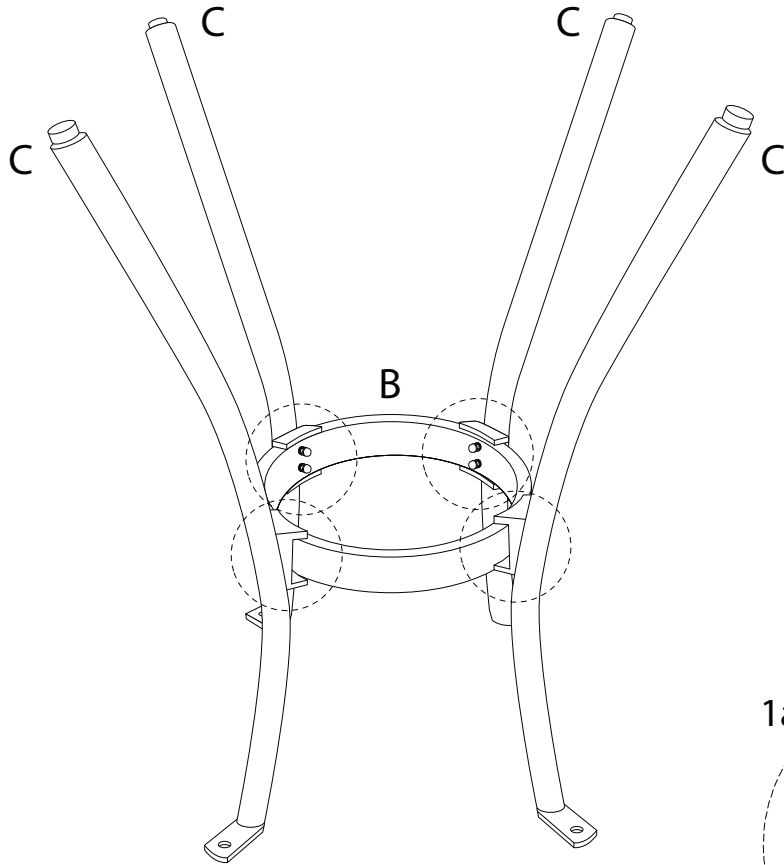

<b>F</b>	<b>G</b>	<b>H</b>	<b>I</b>	<b>J</b>	<b>K</b>
					
<b>x 12</b>	<b>x 12</b>	<b>x 8</b>	<b>x 12</b>	<b>x 2</b>	<b>x 2</b>

1

<b>B</b>  x 1	<b>C</b>  x 4	<b>E</b>  x 8	<b>F</b>  x 8	
<b>G</b>  x 8	<b>H</b>  x 8	<b>I</b>  x 8	<b>J</b>  x 1	<b>K</b>  x 1

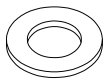
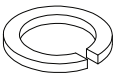

2

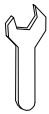
<p>A</p>  <p>x 1</p>	<p>D</p>  <p>x 4</p>	<p>E</p>  <p>x 4</p>	<p>F</p>  <p>x 4</p>
<p>G</p>  <p>x 4</p>	<p>I</p>  <p>x 4</p>	<p>J</p>  <p>x 1</p>	<p>K</p>  <p>x 1</p>

