

ASSEMBLY INSTRUCTION

Thank you for purchasing this quality product. Be sure to check all packing material carefully for small parts which may have come loose inside the carton during shipment. Identify and count all parts and compare with the Parts List below.









For items use on wooden floor, hard surfaces or carpets, it is recommended to Install protective pads under all legs and supports to avoid/ prevent from damages/ scratches and discoloration.















Pour les articles Utilisés sur un plancher en bois, des surfaces dures ou tapis, il est recommandé d'installer des mordaches de protection sous tous les jambes et prend en charge pour éviter/empêcher de dommages/raures et la décoloration.

Hardware may loosen over time. periodically check to make sure all connections are tight. Re-tighten if necessary.

PARTS LIST

NO	DRAWING	Q'TY	DESCRIPTION
1		1	CURIO
2		2	LEG 2
3		2	LEG 3
4		1	LOWER STRETCHER
5		1	UPPER STRETCHER
6		2	GLASS SHELF

A	FURNITURE TIPPING RESTRAINT			
Strap	Anchor	Brackets	Screw (Ø8x1")	Screw (Ø8x5/8")
				
1pc	1pc	2pcs	1pc	1pc

NO	DRAWING	Q'TY	DESCRIPTION
B		8	Ø5/16"*19*2mm FLAT WASHER
C		8	Ø5/16" LOCK WASHER
D		8	Ø5/16"-18*2" BOLT
E		1	Ø5/16" ALLEN KEY
F		1	#8*3/4" WOOD SCREW
G		4	#8*1" WOOD SCREW
H		8	SHELF PIN
I		8	Ø12*2mm FOAM TAPE

ASSEMBLY INSTRUCTION

Thank you for purchasing this quality product. Be sure to check all packing material carefully for small parts which may have come loose inside the carton during shipment. Identify and count all parts and compare with the Parts List below.

! For items use on wooden floor, hard surfaces or carpets, it is recommended to install protective pads under all legs and supports to avoid/ prevent from damages/ scratches and discoloration.

! Pour les articles Utilisés sur un plancher en bois, des surfaces dures ou tapis, il est recommandé d'installer des mordaches de protection sous tous les jambes et prend en charge pour éviter/empêcher de dommages/ rayures et la décoloration.

Hardware may loosen over time. periodically check to make sure all connections are tight. Re-tighten if necessary.

STEP 1

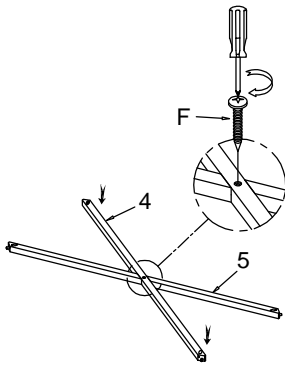

STEP 2

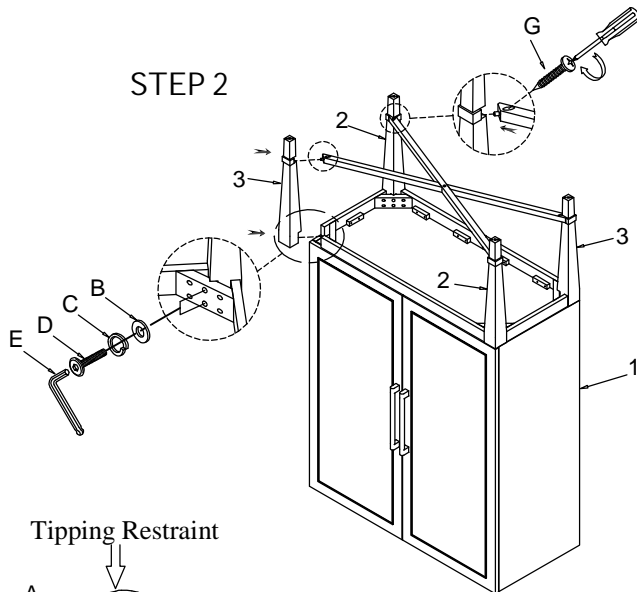

STEP 3

