

### Features

- Two Lever handles offer separate control of hot and cold water
- 5-15/16" (151 mm) spout reach
- 0.5 gpm (1.9 lpm) maximum flow rate at 60 psi (4.14 bar)
- KOHLER® ceramic disc valves exceed industry longevity standards for a lifetime of durable performance
- Clicker drain with tailpiece and overflow
- Coordinates with other products in the Tone collection
- This product can help a building earn Water Efficiency points in LEED® Green Building Rating System

### Material

- Premium material construction for durability and reliability
- KOHLER finishes resist corrosion and tarnishing

### Installation

- For 4" (102 mm) centers
- Deck-mount
- Handles are preassembled on valves to simplify installation

### Recommended Products/Accessories

K-23726 Drain treatment



ADA
CSA B651
OBC

### Codes/Standards







ASME A112.18.1/CSA B125.1  
 NSF/ANSI/CAN 61  
 NSF/ANSI/CAN 372  
 DOE - Energy Policy Act 1992  
 California Energy Commission (CEC)  
 ADA  
 ICC/ANSI A117.1  
 CSA B651  
 OBC

### KOHLER® Faucet Lifetime Limited Warranty

See website for detailed warranty information.

### Available Colors/Finishes

*Color tiles intended for reference only.*

Color	Code	Description
	CP	Polished Chrome
	BN	Vibrant® Brushed Nickel
	BL	Matte Black
	2MB	Vibrant® Brushed Moderne Brass
	BMB	Matte Black with Moderne Brass
	CBL	Matte Black with Polished Chrome

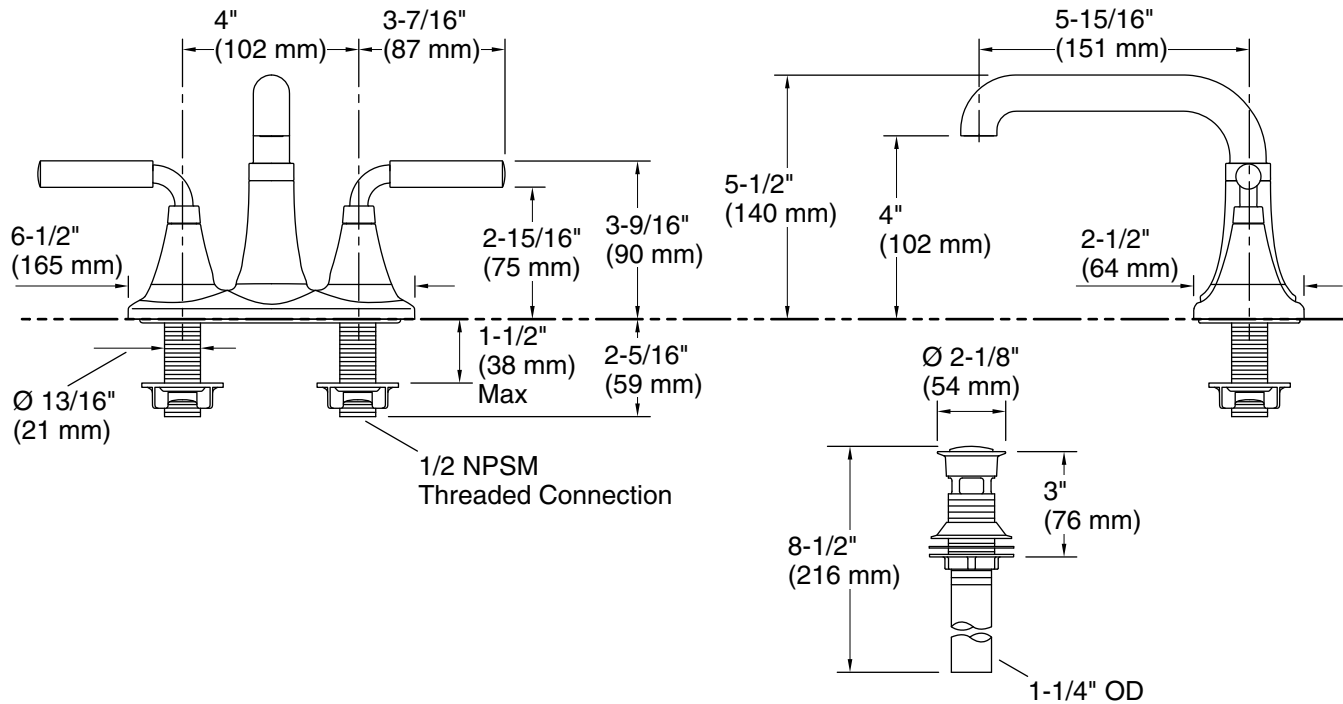

### Technical Information

All product dimensions are nominal.

Faucet flow rate: 0.5 gal/min (1.9 l/min)

Drain included: Yes

### Spout:

Spout reach: 5-15/16" (151 mm)

### Notes

Install this product according to the installation instructions.

ADA, OBC, CSA B651 compliant when installed to the specific requirements of these regulations.