

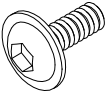

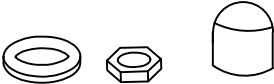

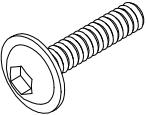



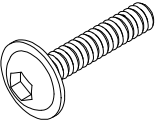
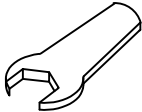

Notice:





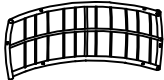
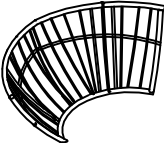

1. Follow the installation instructions. Please confirm all accessories are preset before installation.
2. Do not fully tighten the screws during initial assembly. Fully tighten screws only once all pieces which are correctly assembled.
3. If you encounter any problems during installation, refer to two solutions:

| Item no. | Reference Image | Qty | Item no. | Reference Image | Qty |
|----------|--|-------|----------|---|-------|
| A |  M6*15mm | X19+1 | D |  | X34+3 |
| B |  M6*35mm | X6 | - |  | X1 |
| C |  M6*40mm | X34+3 | - |  | X1 |

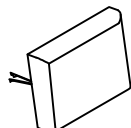

Tips: The number after "+" represents the spare screws.

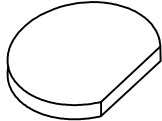
| Item no. | Reference Image | Qty | Item no. | Reference Image | Qty |
|----------|---|-----|----------|---|-----|
| 1 |  | X1 | 5 |  | X1 |
| 2 |  | X1 | 6 |  | X1 |
| 3 |  | X1 | 7 |  | X1 |
| 4 |  | X1 | 8 |  | X1 |

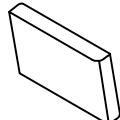
| Item no. | Reference Image | Qty | Item no. | Reference Image | Qty |
|----------|---|-----|----------|---|-----|
| 9 |  | X1 | 13 |  | X4 |
| 10 |  | X1 | 14 |  | X1 |
| 11 |  | X1 | 15 |  | X1 |
| 12 |  | X1 | 16 |  | X2 |

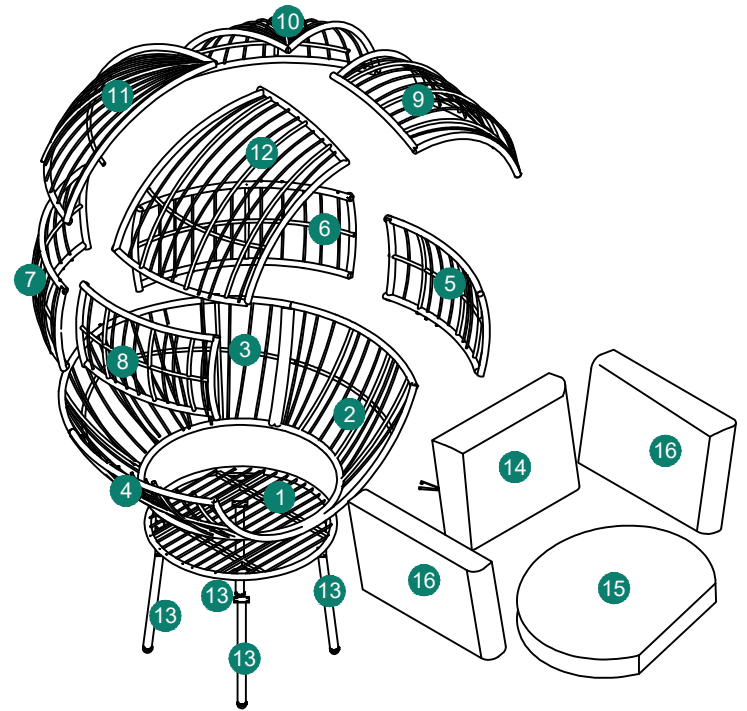

1



Ⓐ 1pcs



Ⓑ 2pcs

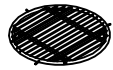

① 1pcs



② 1pcs

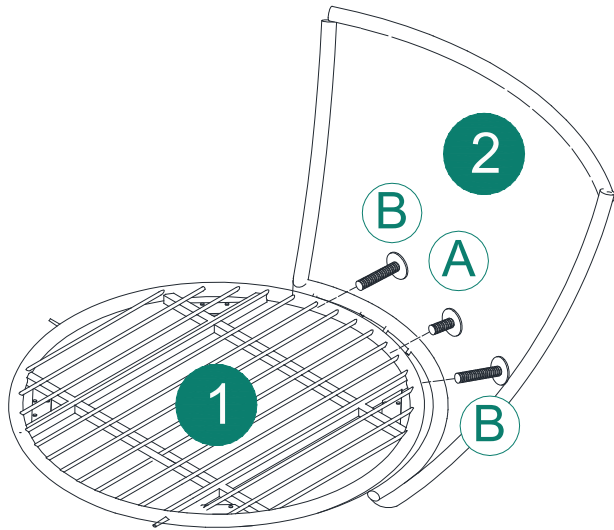

5

2



Ⓐ 1pcs



Ⓑ 2pcs



③ 1pcs

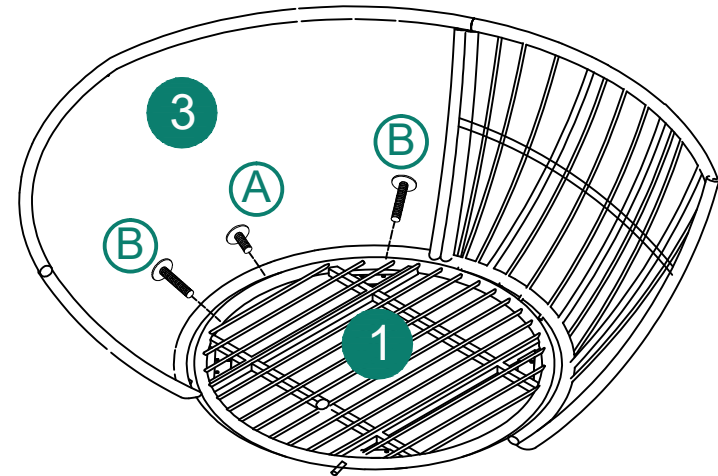

6

3



Ⓐ 1pcs



Ⓑ 2pcs



Ⓒ 4pcs



Ⓓ 4pcs



④ 1pcs

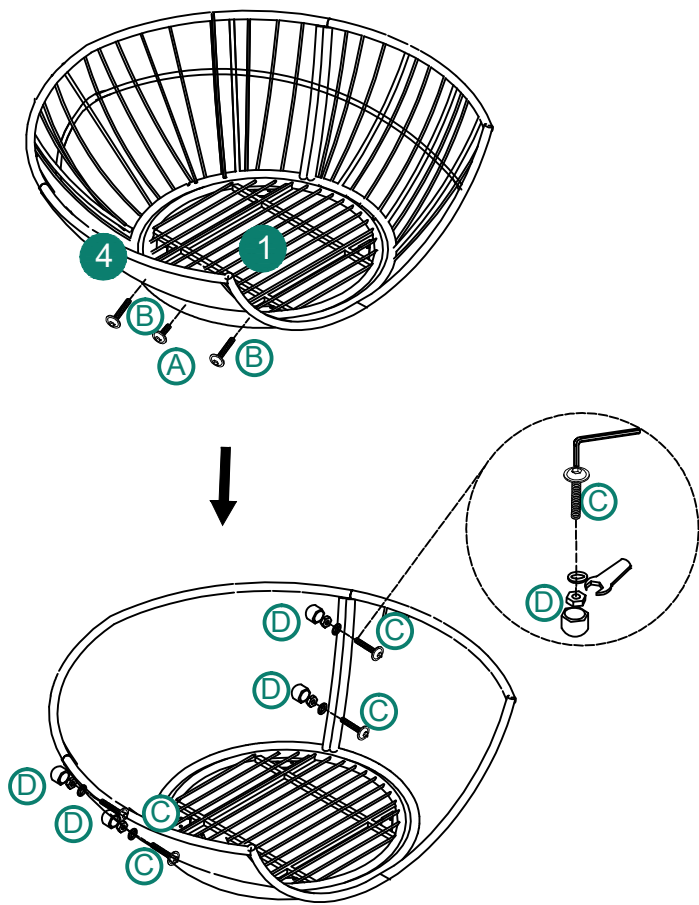

7

4



Ⓐ 16pcs



⑬ 4pcs

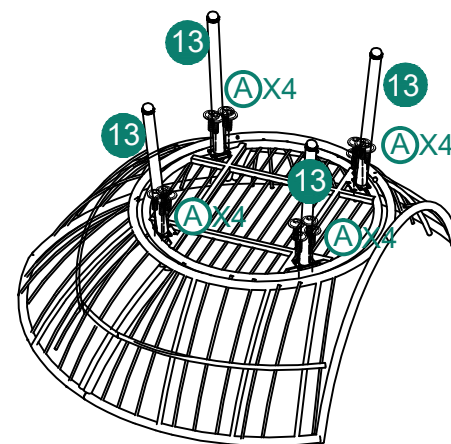

8

5

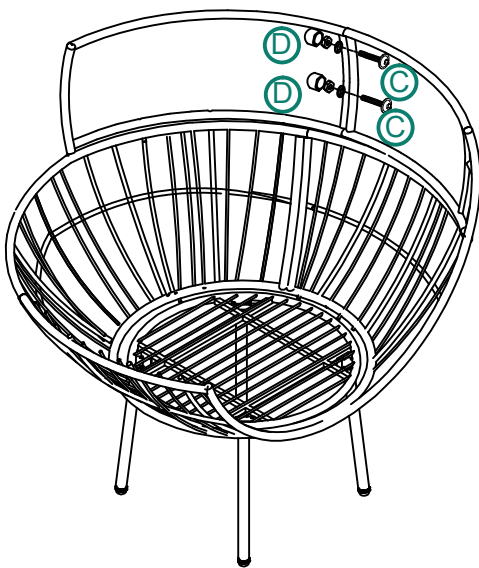
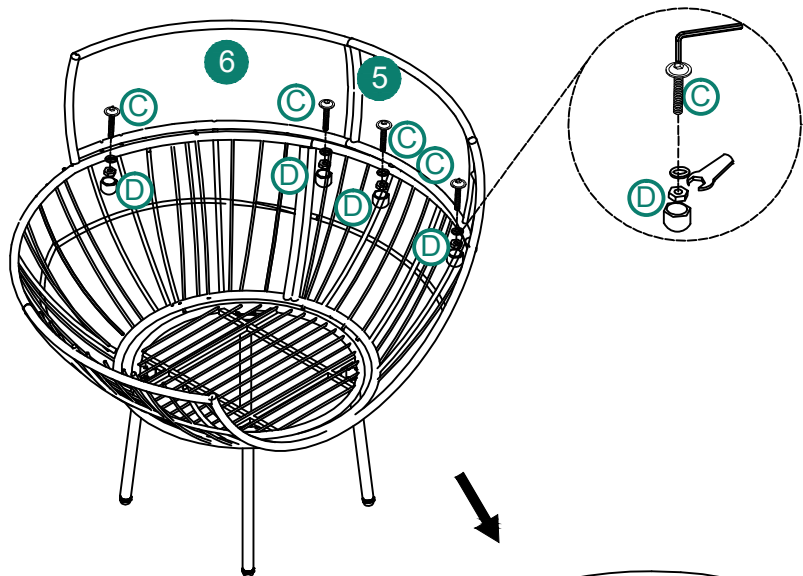

9

6

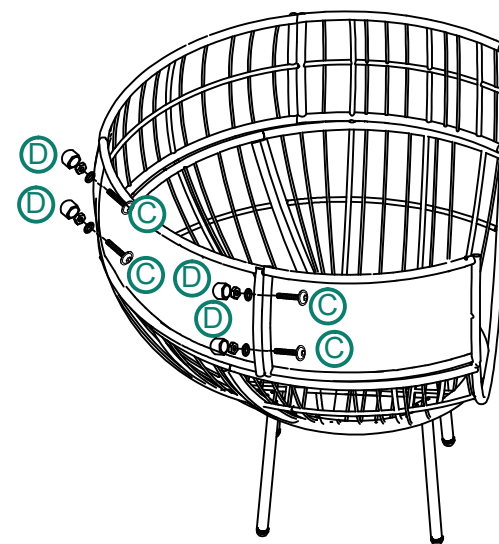
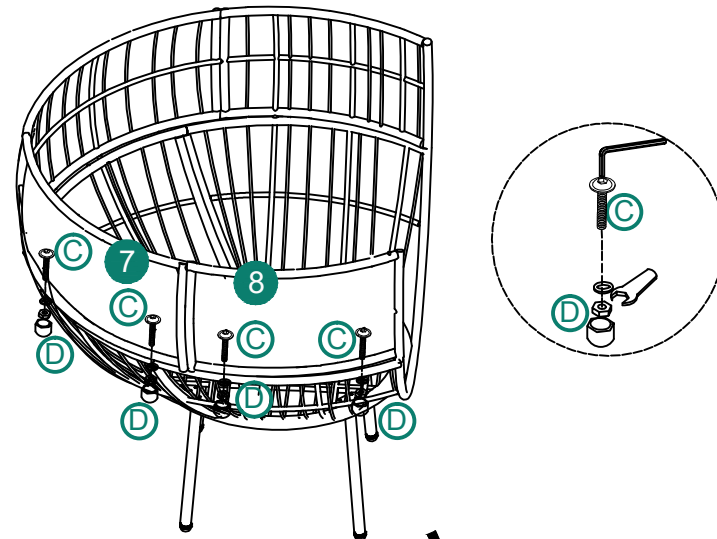

10

7

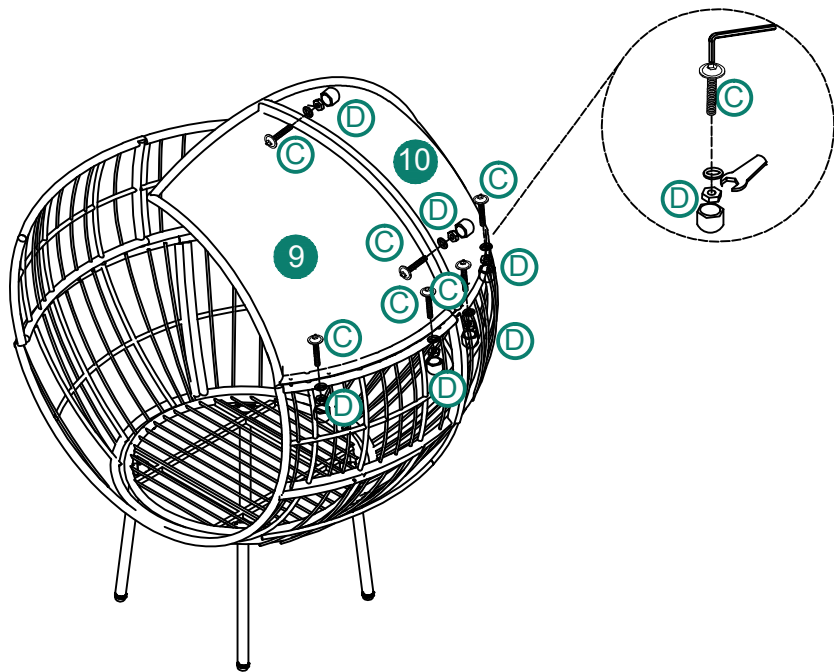

11

8

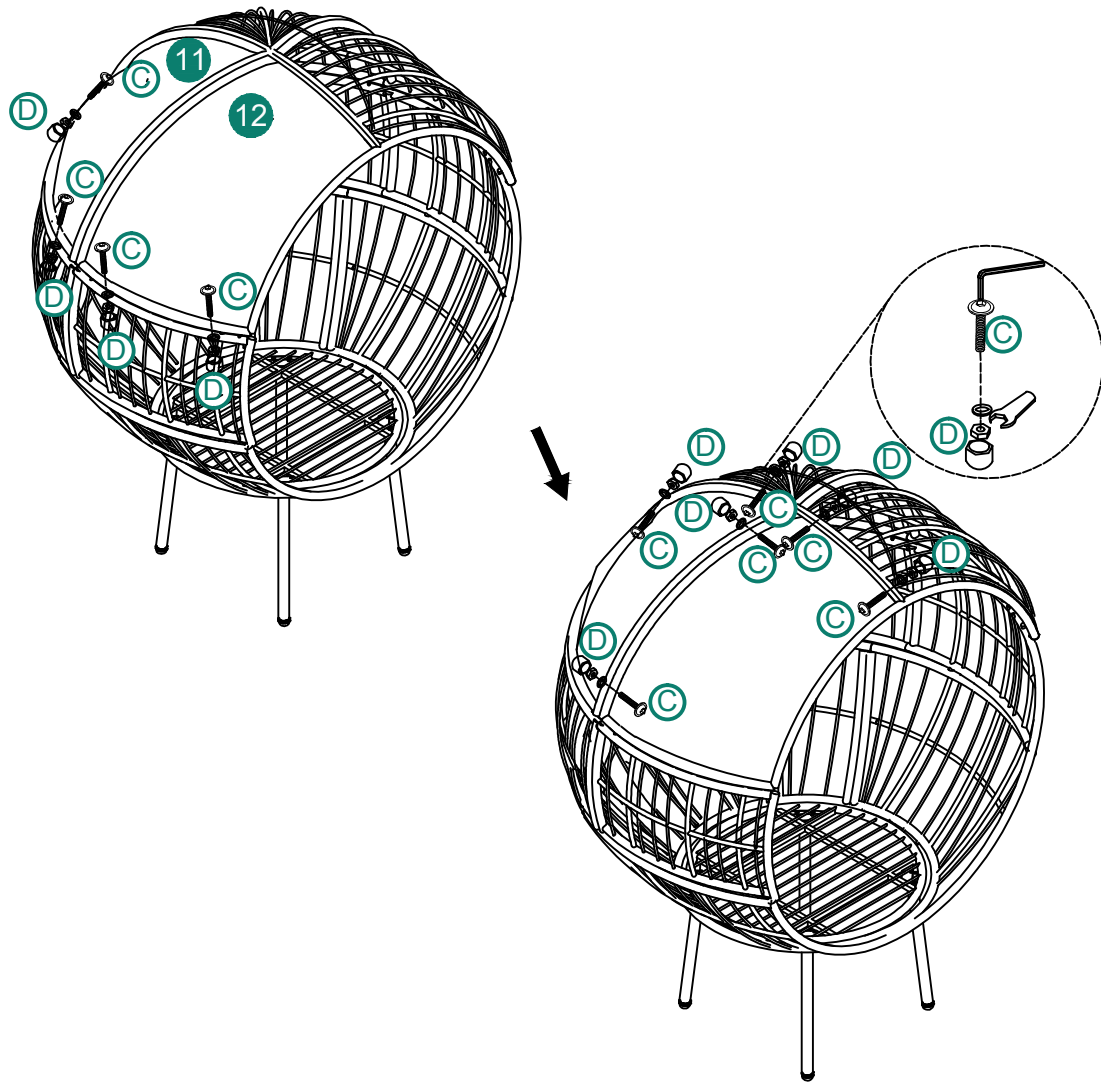
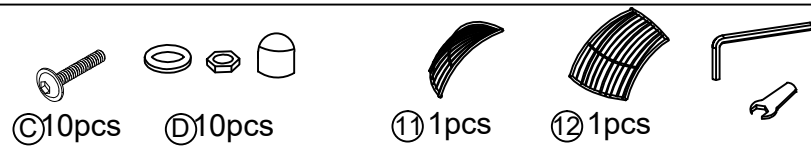

12

9



⑭ 1pcs



⑮ 1pcs

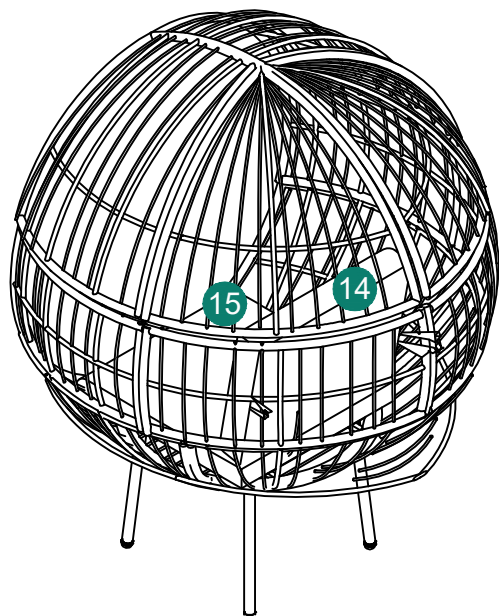

13

10



⑯ 2pcs

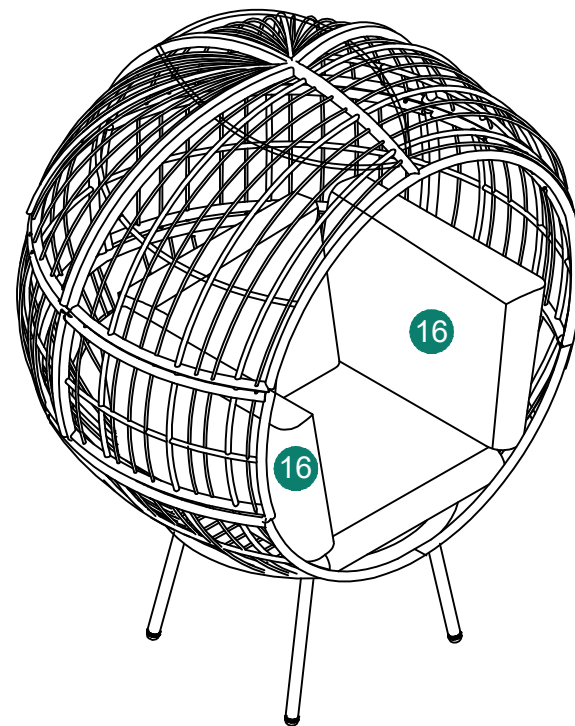

14