

**ASSEMBLY INSTRUCTIONS  
INSTRUCTIONS D'ASSEMBLAGE.**

**Please note that the warning sticker is placed on the toddler bed to keep parents and caregivers informed it is a requirement by law under CPSC And ASTM. we do apologize for any inconvenience this may cause you.**

**Adult assembly required.**

**Small parts may present choking hazard prior to assembly.**

**Enclosed please find simple step-by-step instructions to help you quickly assemble your products. Before you begin we recommend that you following the steps below:**

- 1. Please read the instructions thoroughly.**
- 2. Identify all parts and hardware.**
- 3. You will need the following tools:**

**Philips head screw driver**

**Flat head screw driver**

**Hammer**

**Do Not Use Power Drills or Drivers**

**To protect your parts during assembly please place them on a soft surface.**

**To clean surface use only water on a damp cloth. Do not use window cleaners or cleaning abrasives as it will scratch the surface and could damage the protective coating.**

**Notez s'il vous plaît que l'avertissement sur la table à langer est exigé par la loi de la CPSC et l'ASTM, qui nous oblige d'informer les parents et les personnes en charge des enfants.**

**Nous nous excusons pour toute inconvenance que cela pourrait vous causer.**

**L'assemblage par un adulte de ce meuble est nécessaire.**

**Les petites pièces non-assemblées présentent le risque d'étouffement. Pour vous aider pendant l'assemblage de votre produit, veuillez trouver en bas des instructions simples, en étape. Avant de commencer**

**l'assemblage, les étapes suivantes sont vivement recommandées :**

- 1. Lisez attentivement les instructions.**
- 2. Identifiez toutes les pièces et les outils.**
- 3. Vous avez besoin des outils suivants :**

**Tournevis cruciforme**

**Tournevis plat**

**Marteau**

**N'utilisez pas d'outils électriques.**

**Pour protéger les pièces pendant l'assemblage, placez-les sur une surface souple.**

**Pour nettoyer la surface du meuble n'utilisez que de l'eau sur une lingette humide. N'utilisez pas des nettoyants à vitre ou des nettoyants abrasifs, car ils vont égratigner cette surface et endommager le fini.**

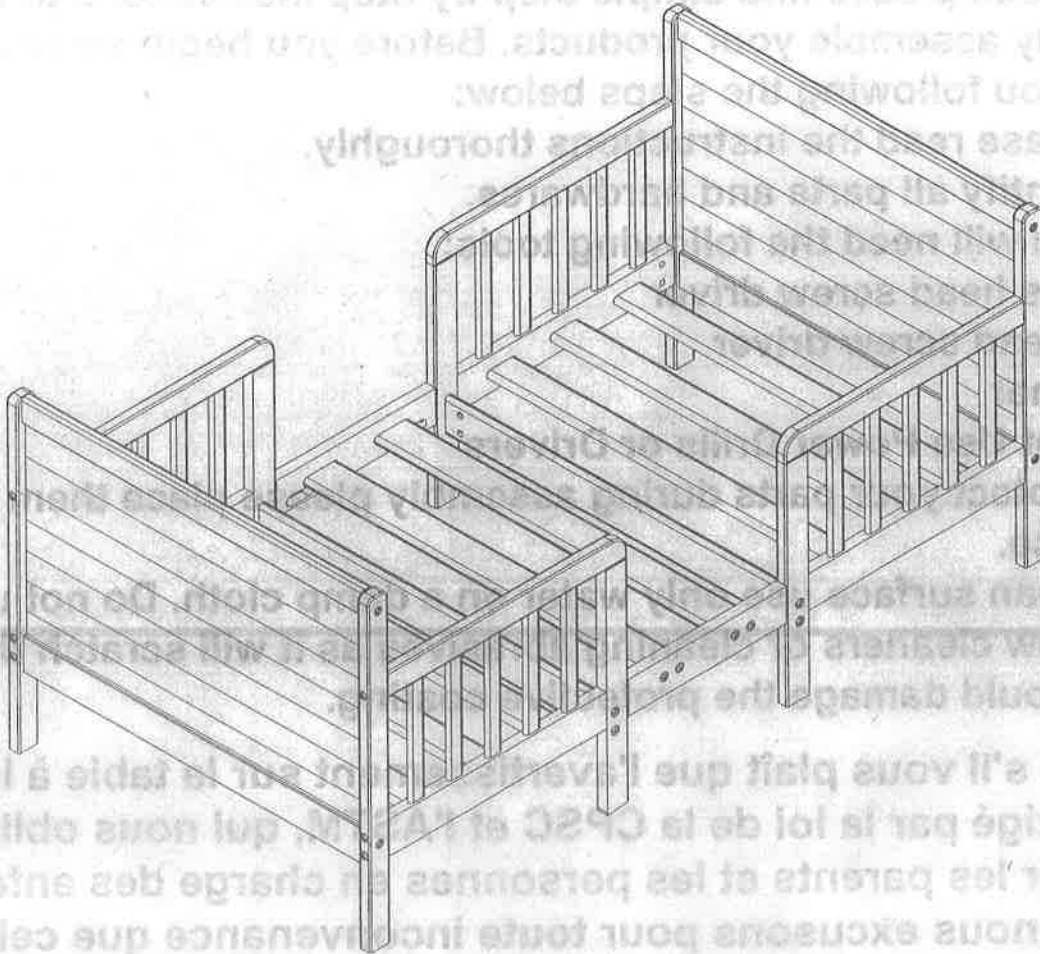



# WARNING!

- FAILURE TO FOLLOW THESE WARNINGS AND THE ASSEMBLY INSTRUCTIONS COULD RESULT IN SERIOUS INJURY OR DEATH.
- READ ALL INSTRUCTIONS BEFORE ASSEMBLING CRIB. KEEP INSTRUCTIONS FOR FUTURE USE.

- UPON COMPLETION OF ASSEMBLY, MAKE SURE ALL SCREWS, BOLTS AND FASTENERS HAVE BEEN SECURELY TIGHTENED. A FREQUENT AND PERIODICALLY CHECK SHOULD BE MADE TO CONFIRM ALL THE SCREWS AND NUTS REMAIN TIGHT.
- NEVER USE THIS PRODUCT IF THERE ARE ANY LOOSE, MISSING FASTENERS, LOOSE JOINTS, BROKEN PARTS, OR TORN MESH/FABRIC.

REPLACEMENT PARTS AND INSTRUCTIONAL LITERATURE IF NEEDED.

- NEVER SUBSTITUTE PARTS, THE PRODUCT INCLUDING SIDE RAILS, MUST BE FULLY ERECTED PRIOR TO USE.
- NEVER USE BED FOR INFANTS, THIS TODDLER BED IS NOT A SUBSTITUTE FOR A CRIB, THE TODDLER BED IS USED FOR A CHILD BETWEEN THE AGE OF 15 MONTHS TO 5 YEARS WITH A MAXIMUM WEIGHT OF 50 POUNDS (22.7KG).
- NEVER USE PLASTIC SHIPPING BAG OR OTHER PLASTIC FILM AS A MATTRESS COVERS NOT SOLD AND INTENDED FOR THAT PURPOSE, THEY CAN CAUSE SUFFOCATION.
- CAUTION ENTRAPMENT HAZARD: TO AVOID DANGEROUS GAPS, ANY MATTRESS USED IN THIS BED SHALL BE FULL SIZE CRIB MATTRESS AT LEAST 51-5/8 IN (1310MM) IN LENGTH, 27-1/4 IN (690MM) IN WIDTH AND 4 IN (100MM) IN THICKNESS, OR GREATER, BUT NOT EXCEED 5 IN.
- NEVER USE A WATER MATTRESS WITH THIS TODDLER BED.
- WARNING STRANGULATION HAZARD: STRINGS CAN CAUSE STRANGULATION! NEVER PLACE BED NEAR WINDOW WHERE CORDS FROM BLINDS OR DRAPES MAY STRANGLE A CHILD. NEVER SUSPEND STRINGS OVER BED. NEVER PLACE ITEMS WITH A STRING CORD, OR RIBBON, SUCH AS HOOD STRINGS, PACIFIER CORDS AROUND A CHILD'S NECK. THESE ITEMS MAY CATCH ON BED PARTS.
- WARNING: INFANTS HAVE DIED IN TODDLER BEDS FROM ENTRAPMENT. OPENINGS IN AND BETWEEN BED PARTS CAN ENTRAP HEAD AND NECK OF A SMALL CHILD. NEVER USE BED WITH CHILDREN UNDER 15 MONTHS. ALWAYS FOLLOW THE ASSEMBLY INSTRUCTIONS.
- TO REDUCE THE RISK OF SIDS, PEDIATRICIANS RECOMMEND HEALTHY INFANTS BE PLACED ON THEIR BACK TO SLEEP, OR ADVISED BY YOUR PHYSICIAN.
- DO NOT USE BED IF THE SPACE BETWEEN BED AND SOLID OBJECTS IS LESS THAN 12 IN (31CM), A CHILD COULD SLID INTO THE SPACE AND SUFFOCATE.
- IF REFINISHING, USE A NON-TOXIC FINISH SPECIFIED FOR CHILDREN'S PRODUCTS. TO WASH, CLEAN WITH MILD SOAP AND DAMP CLOTH. TO STORE, PLEASE KEEP IN A COOL PLACE.

MADE IN CHINA



# MISE EN GARDE !

- LE NON-RESPECT DES AVERTISSEMENTS ET DES INSTRUCTIONS D'ASSEMBLAGE PEUT CONDUIRE A DES BLESSURES GRAVES OU À LA MORT.
- LISEZ TOUTES LES INSTRUCTIONS AVANT L'ASSEMBLAGE DU LIT. GARDEZ LE MANUEL POUR UNE UTILISATION FUTURE.
- APRÈS AVOIR FINI L'ASSEMBLAGE DU LIT DE BÉBÉ, VÉRIFIEZ QUE TOUS LES ÉCROUS, LES BOULONS ET LES VIS SONT FERMEMENT SERRÉS.  
DES INSPECTIONS RÉGULIÈRES ET FRÉQUENTES POUR VÉRIFIER QUE TOUTES LES VIS ET ÉCROUS SONT SERRÉES SERONT NÉCESSAIRES.
- NE PAS UTILISER CE PRODUIT SI DES FIXATIONS SONT DESSERRÉES OU MANQUANTES, DES JOINTS SONT LÂCHES, SI DES PIÈCES SONT FAUTIVES OU SI LE TISSU PRÉSENTE DES DÉCHIRURES.
- NE PAS SUBSTITUER DE PIÈCES. CE PRODUIT, Y COMPRIS LES REBORDS, DOIT ÊTRE ENTIÈREMENT ASSEMBLÉ AVANT DE L'UTILISATION.
- NE PAS UTILISER CE LIT POUR LES NOURRISSONS. CE LIT D'ENFANT NE REMPLACE PAS UN BERCEAU; LE LIT D'ENFANT EST POUR LES ENFANTS ÂGÉS DE 15 MOIS À 5 ANS, AVEC UN POIDS MAXIMAL DE 22.7KG (50 LIVRES).
- NE JAMAIS UTILISER LES SACS D'EXPEDITION EN PLASTIQUE OU TOUT AUTRE FILM EN PLASTIQUE, POUR COUVRIR LE MATELAS, S'ILS NE SONT PAS DESTINÉS À CET USAGE, CAR ILS PEUVENT CAUSER LA SUFFOCATION.
- ATTENTION RISQUE DE PIÉGEAGE : POUR ÉVITER LES ESPACES DANGEREUX, LES MATELAS UTILISÉS AVEC CE LIT DOIVENT ÊTRE DE TAILLE STANDARD ET MESURER AU MOINS 1310 MM (51 5/8 POUCES) PAR 690 MM (27 1/4 POUCES) POUR UNE ÉPAISSEUR D'AU MOINS 100 MM (4 POUCES). L'ÉPAISSEUR DU MATELAS NE DOIT PAS DÉPASSER 5 POUCES.
- NE PAS UTILISER UN MATELAS À EAU AVEC CE LIT.
- MISE EN GARDE RISQUE D'ÉTRANGLEMENT : DES CORDES PEUVENT CAUSER LA STRANGULATION ! NE PLACEZ PAS LE LIT AUPRÈS D'UNE FENÊTRE LÀ OÙ LES CORDES DES STORES OU DRAPERIES POURRONT ÉTRANGLER UN BÉBÉ. NE PAS SUSPENDRE DES CORDES EN DESSUS DU LIT.  
NE JAMAIS PLACER DES OBJETS ATTACHÉS PAR UNE CORDE AUTOUR DU COU DE VOTRE BÉBÉ, COMME PAR EXEMPLE CELLE D'UN CAPUCHON OU D'UNE SUCETTE. CES OBJETS POURRAIENT SE COINCER DANS DES PIÈCES DU LIT.
- MISE EN GARDE : DES ACCIDENTS MORTELS PAR COINCEMENT SONT DÉJÀ SURVENUS DANS DES LITS D'ENFANTS. UN PETIT ENFANT PEUT COINCER SA TÊTE ET SON COU DANS LES OUVERTURES SITUÉES DANS ET ENTRE LES PARTIES DU LIT D'ENFANT. N'UTILISEZ JAMAIS LE LIT D'ENFANT POUR DES ENFANTS DE MOINS DE 15 MOIS. SUIVEZ TOUJOURS LES INSTRUCTIONS DE MONTAGE.
- POUR RÉDUIRE LES RISQUES DU SYNDROME DE LA MORT SUBITE DU NOURRISSON, LES MÉDECINS PÉDIATRES VOUS RECOMMANDENT DE PLACEZ SUR LE DOS LE BÉBÉ PENDANT LE SOMMEIL, EXCEPTÉ DANS LES CAS OÙ VOTRE MÉDECIN ÉMET UN AVIS DIFFÉRENT.
- LE LIT D'ENFANT DOIT ÊTRE PLACÉ À UNE DISTANCE DE PLUS DE 31CM (12 PO) DE N'IMPORTE QUEL OBJET SOLIDE. L'ENFANT POURRAIT GLISSER DANS DES ESPACES ÉTROITS ET SUFFOQUER.
- SI VOUS VOULEZ RENOUELER LA COUCHE DE FINITION, UTILISEZ UN FINI NON TOXIQUE RECOMMANDÉ POUR DES PRODUITS DESTINÉS AUX ENFANTS. NETTOYEZ AVEC UN SAVON DOUX ET UN CHIFFON MOITE. POUR ENTREPOSER LE LIT, GARDEZ-LE DANS UN ENDROIT FRAIS.

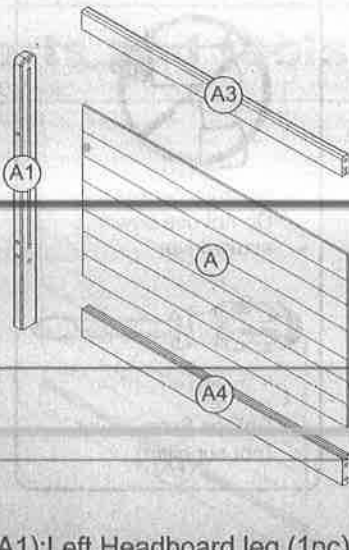

- (A1):Left Headboard leg (1pc)
- (A2):Right Headboard leg (1pc)
- (A3):Headboard Top Rail (1pc)
- (A4):Headboard Bottom Rail (1pc)
- (A) Headboard panel 1PC

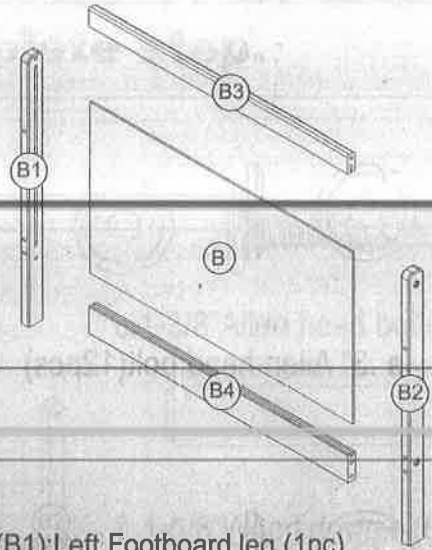

- (B1):Left Footboard leg (1pc)
- (B2):Right Footboard leg (1pc)
- (B3):Footboard Top Rail (1pc)
- (B4):Footboard Bottom Rail (1pc)
- (B) Footboard panel 1PC

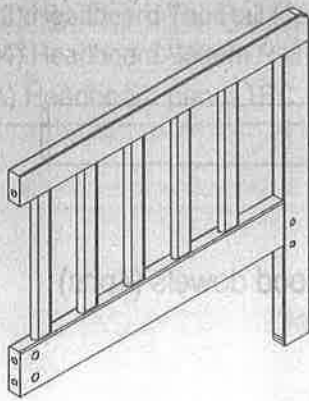

C. Right bed rail (2pcs)

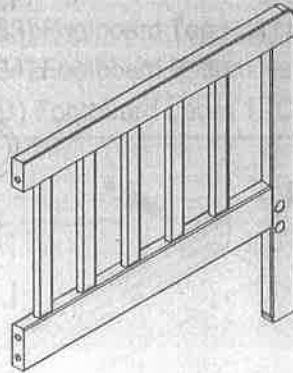

D. Left bed rail (2pcs)

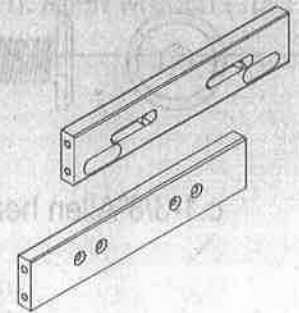

E. Middle bar (2pcs)

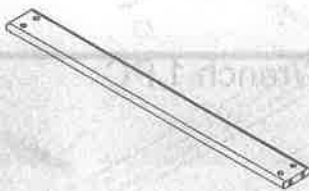

F. Cross Middle Bar (2 pcs)

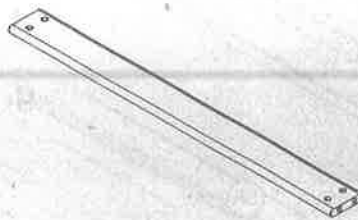

G. Cross Bar (2pcs)

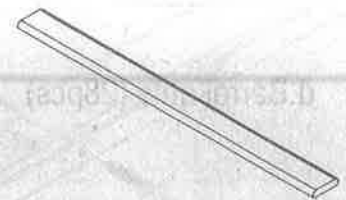

H. Cross Bar ( 6pcs)

POUCH ATTACHED TO MATTRESS SUPPORT  
 -KEEP INSTRUCTIONS IN THIS POUCH  
 AFTER ASSEMBLY.  
 WARNINGS RELATED TO THE SAFE USE OF  
 THIS CRIB ARE PRINTED ON THE POUCH.

# PARTS: HARDWARE KIT

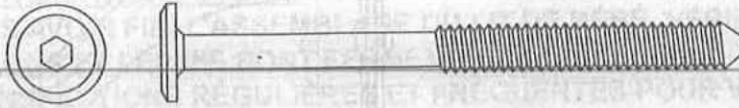

a. 3" Allen head bolt(12pcs)

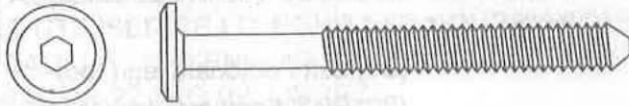

b. 2-3/8" Allen head bolt(16pcs)

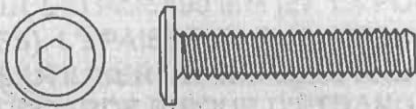

c. 1-3/8" Allen head bolt(8pcs)

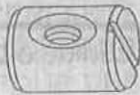

d. Barrel nuts (28pcs)



e. Spacer (4pcs)



f. 1-1/4" Wood dowels (8pcs)

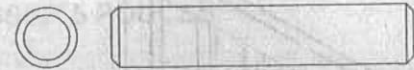

i. 1-5/8" Wood dowels (4pcs)

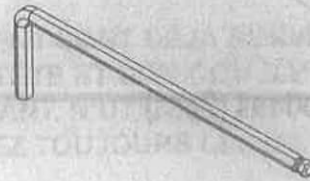

g. Allen Wrench 1 PC

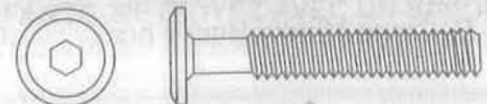

h. 4/5" Allen head bolt(4pcs)



No drills necessary.  
Do not use power  
screwdriver



Phillips Screwdriver  
(not supplied)

# STEP 1

## Parts and tools required to complete step.

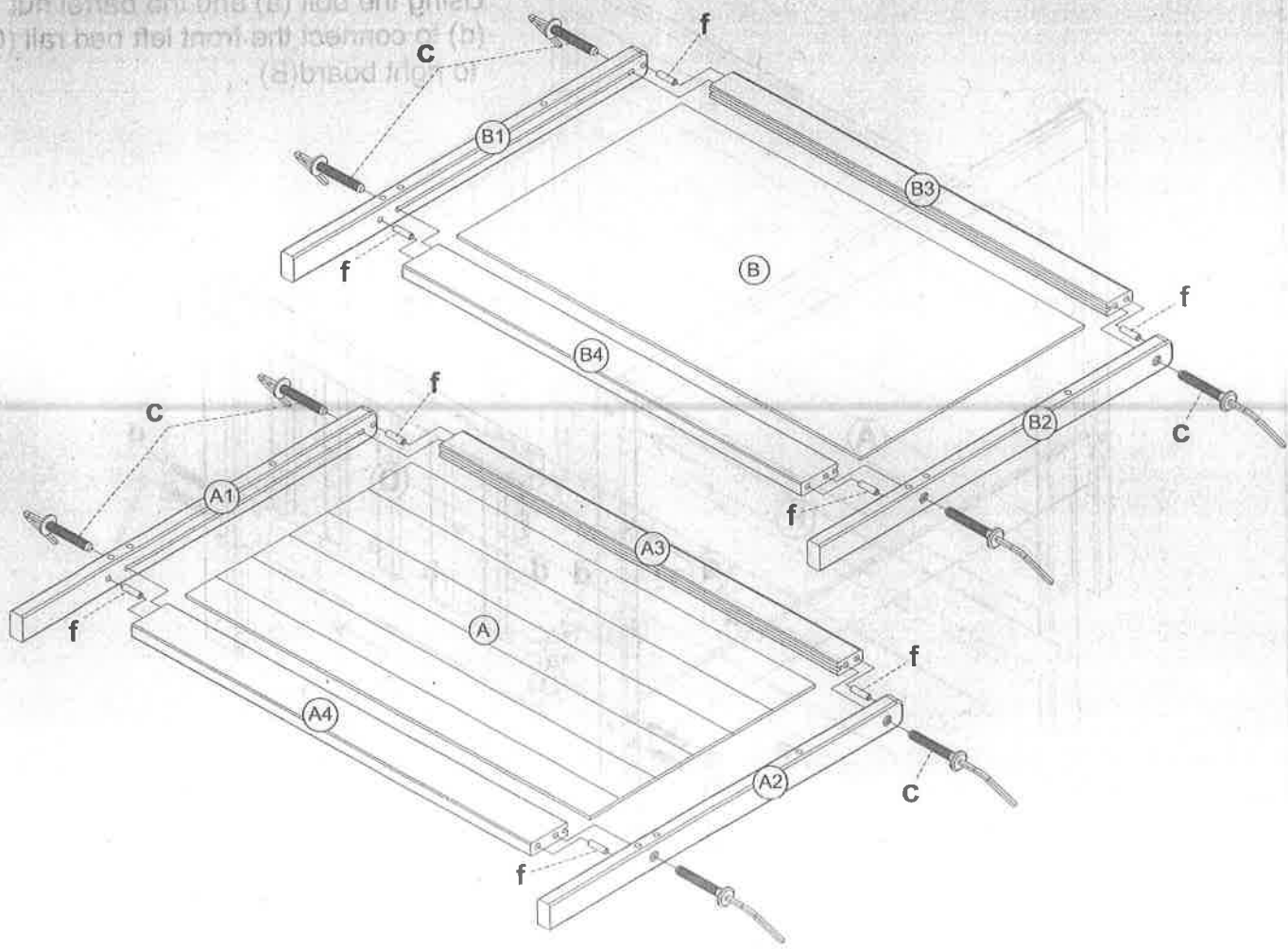
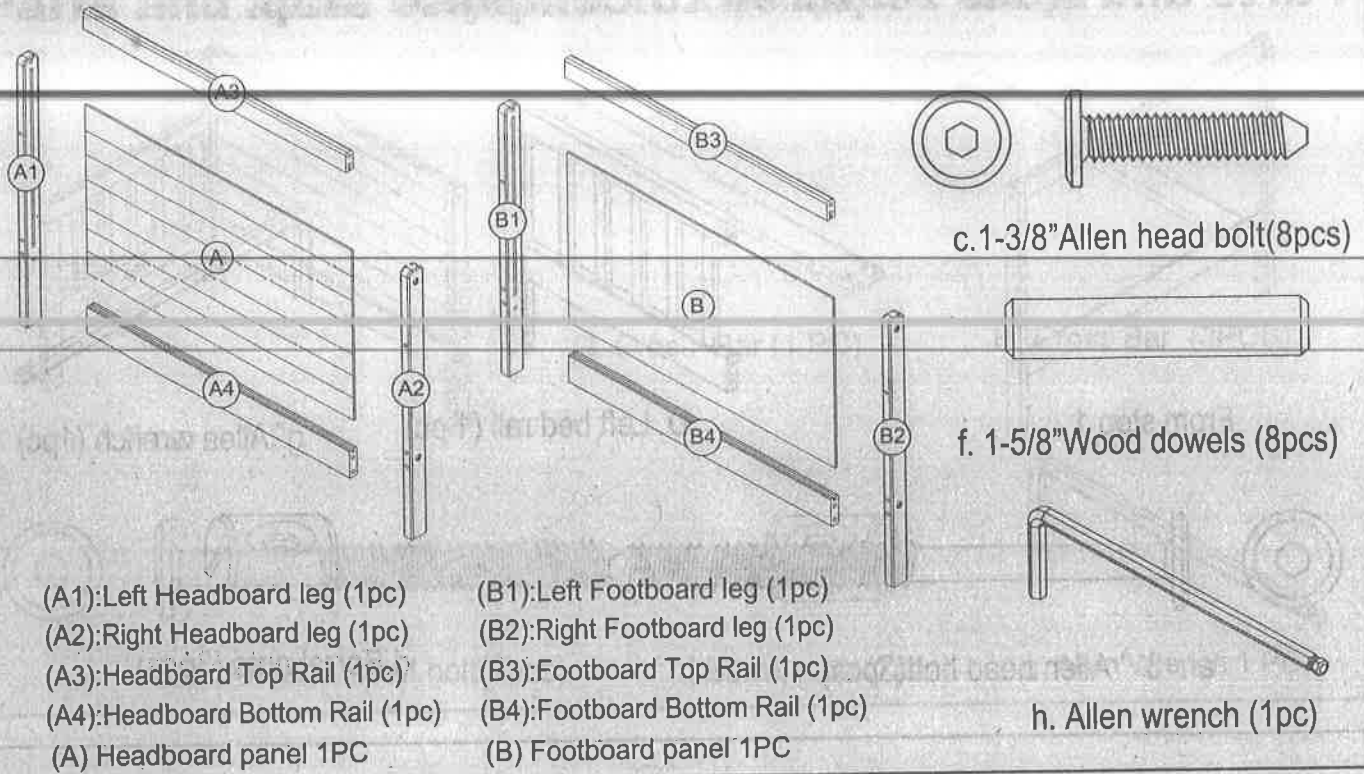

# SECTION 1: Crib Assembly

## STEP 2

### Parts and tools required to complete step.

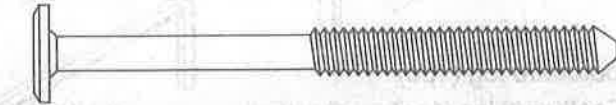
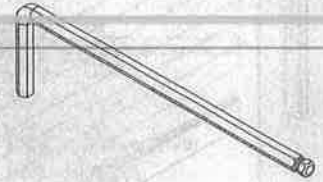
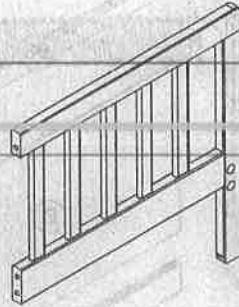
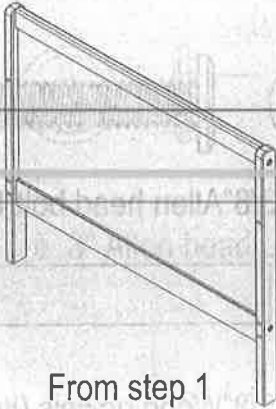

a . 3 " Allen head bolt(3pcs)

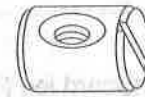

d.Barrel nuts (3pcs)

Using the bolt (a) and the barrel nut (d) to connect the front left bed rail (C) to right board (B).

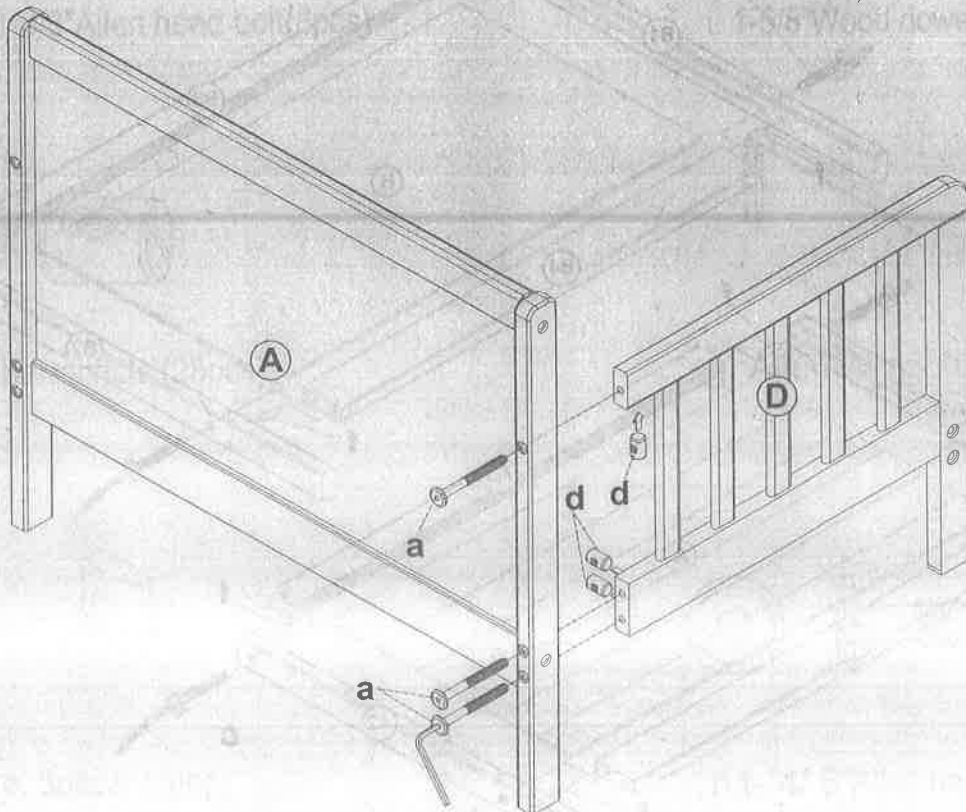



# STEP 3

## Parts and tools required to complete step.

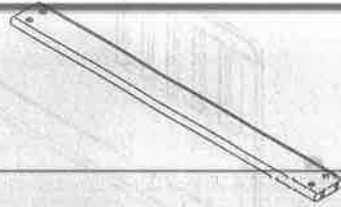
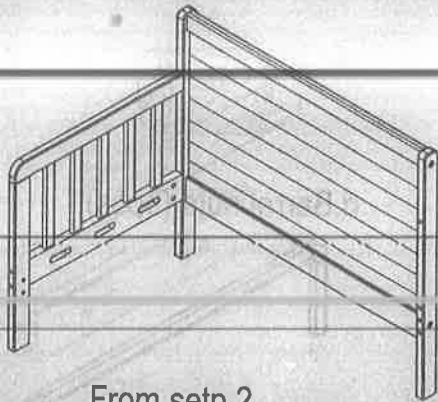

G. Cross Bar (1 PC)

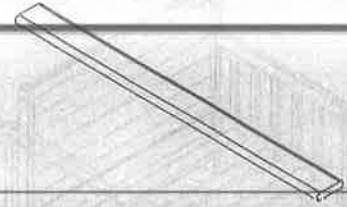

H. Cross Bar (3PCS)

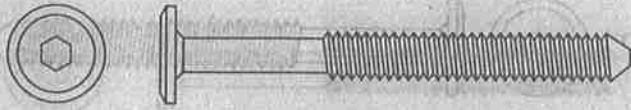

b. 2-3/8" Allen head bolt (2pcs)



d. Barrel nuts (2pcs)

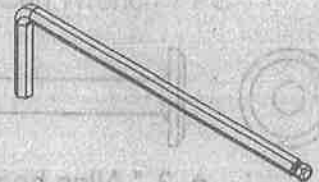

g. Allen Wrench 1 PC

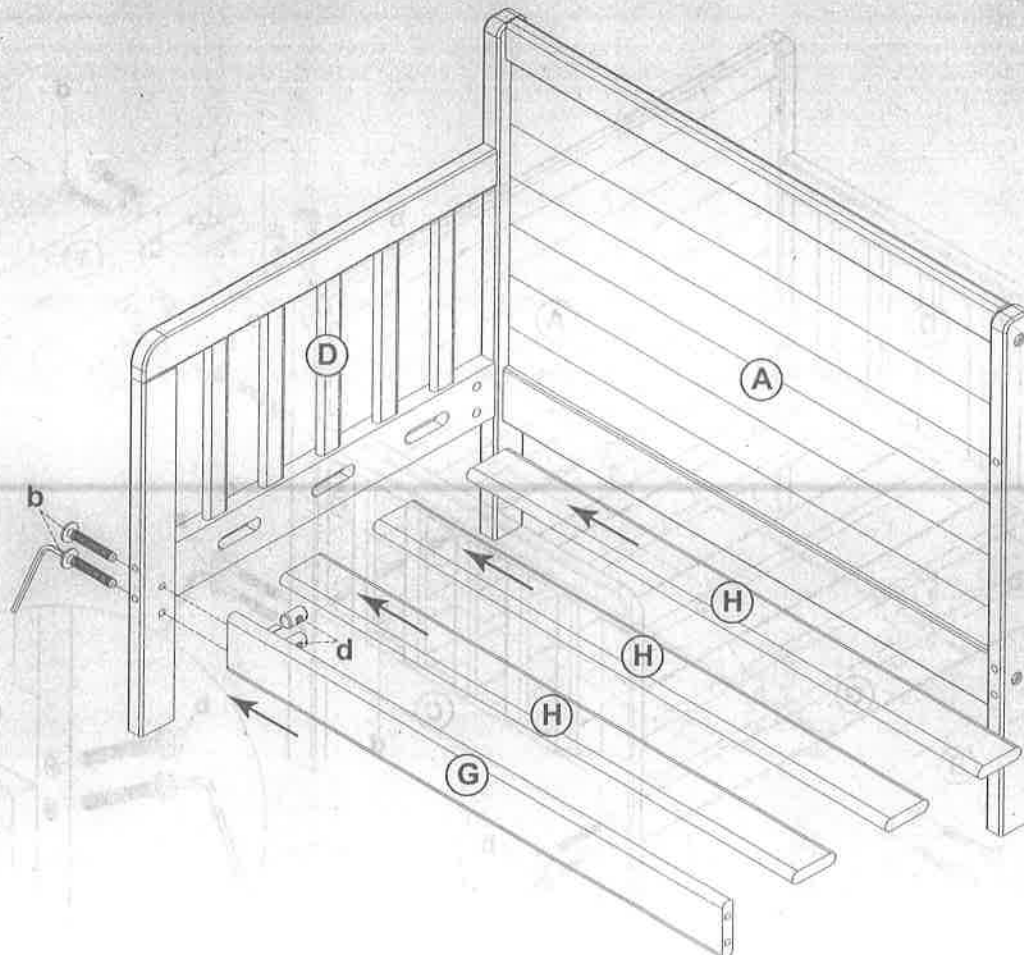

# SECTION 1: Crib Assembly

## STEP 4

### Parts and tools required to complete step.

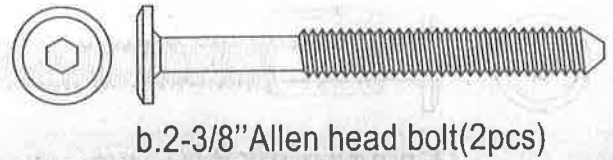
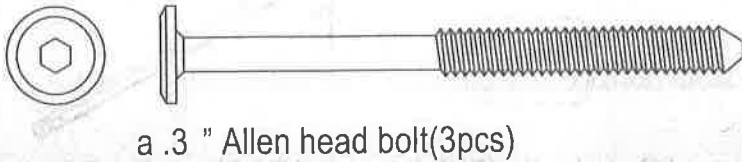
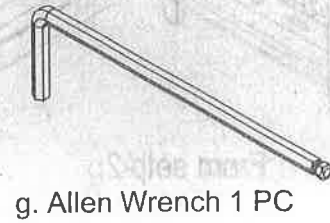
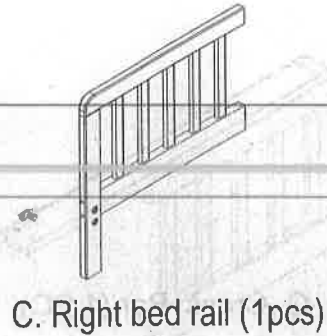
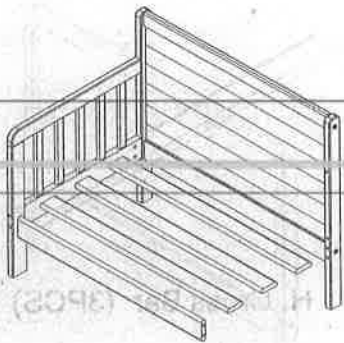

Repeat the step 1 - step 4 to assemble the footboard, by using the parts for the footboard in the parts list.

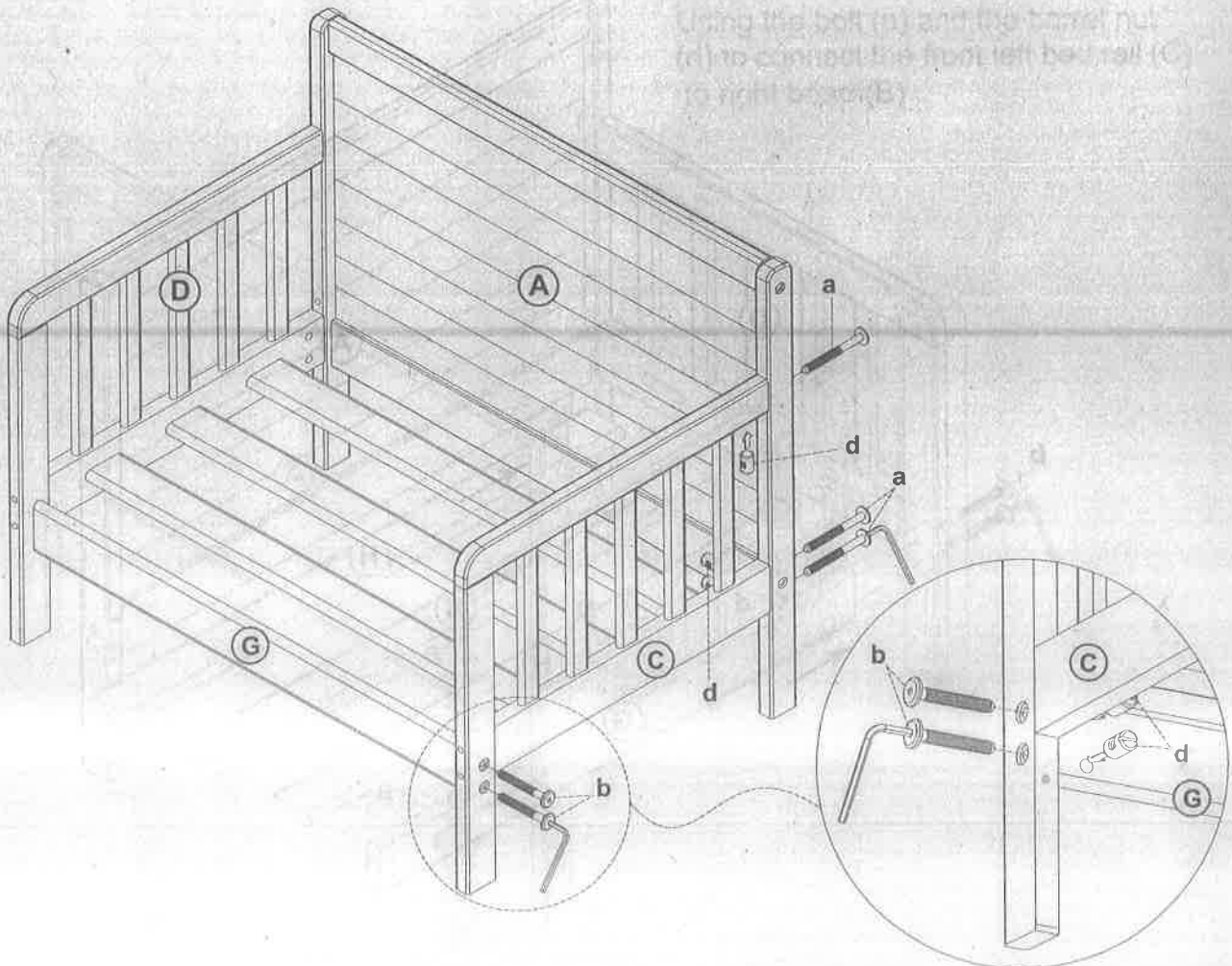

# STEP 5

## Parts and tools required to complete step.

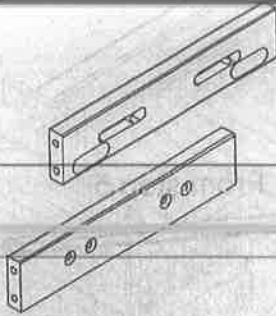

E. Middle bar (2 pcs)

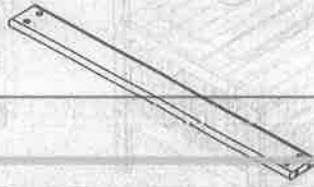

F. Cross Middle Bar (2 pcs)

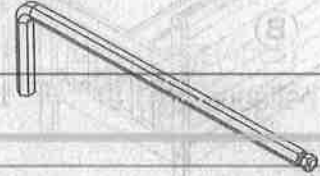

g. Allen Wrench: 1-PC

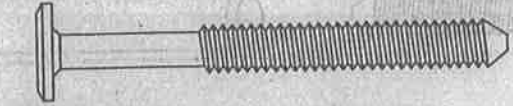

b. 2-3/8" Allen head bolt (8 pcs)



d. Barrel nuts (8 pcs)

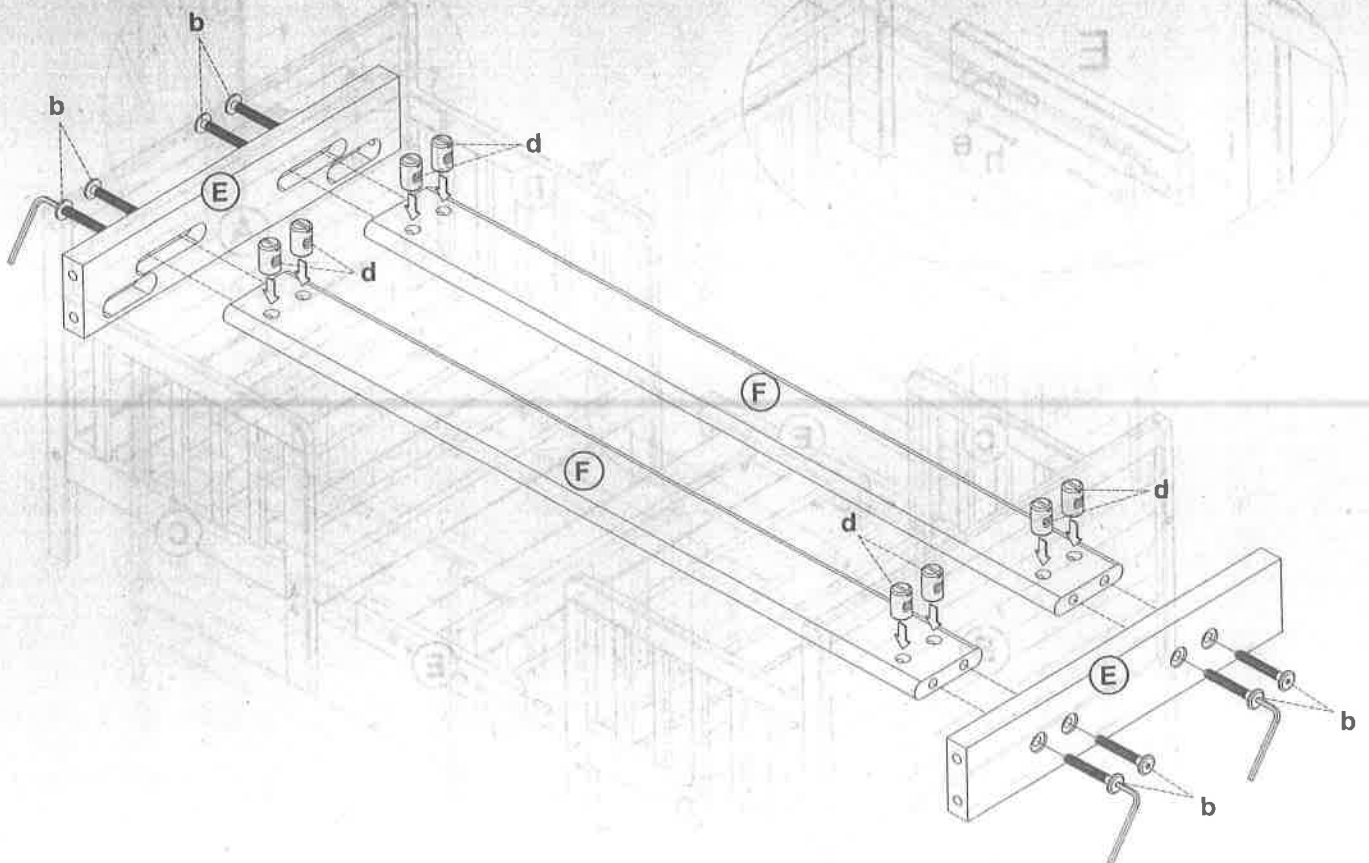

# SECTION 1: Crib Assembly

## STEP 6

Parts and tools required to complete step.

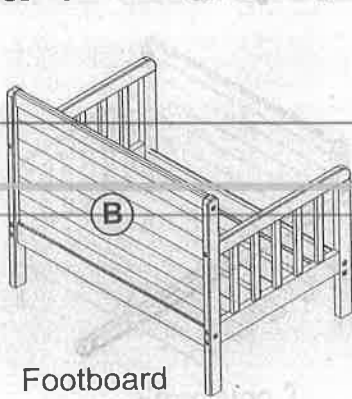

From step 4

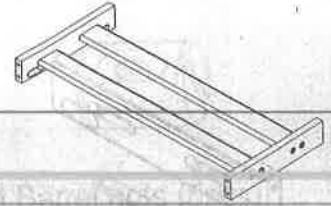
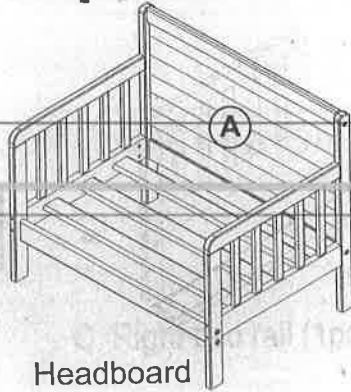

From step 5

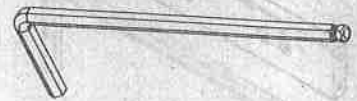

M4 ALLEN WRENCH  
SUPPLIED



e. Crescent Washer x 4



h. 1-4/5 "Allen head bolt(4pcs)



i. Wood dowels (4pcs)

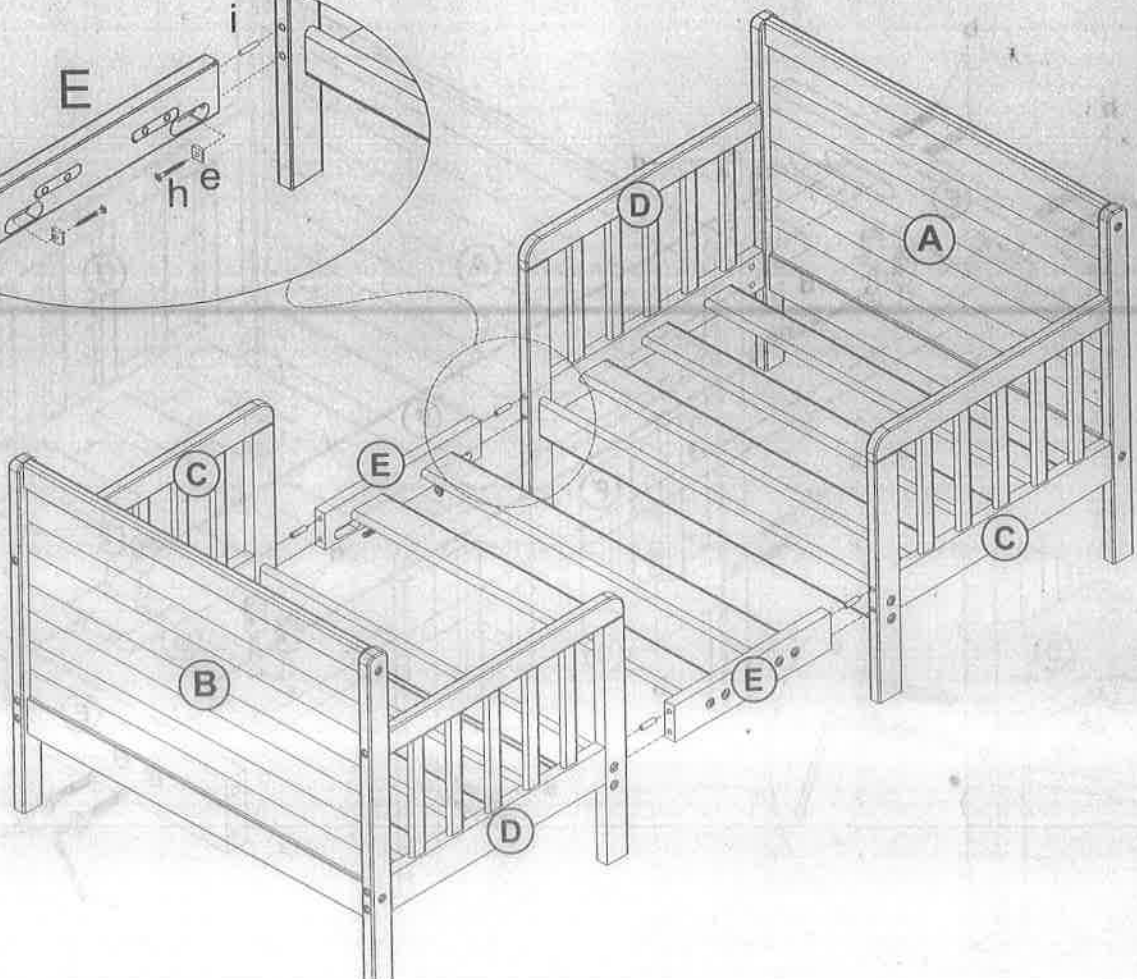
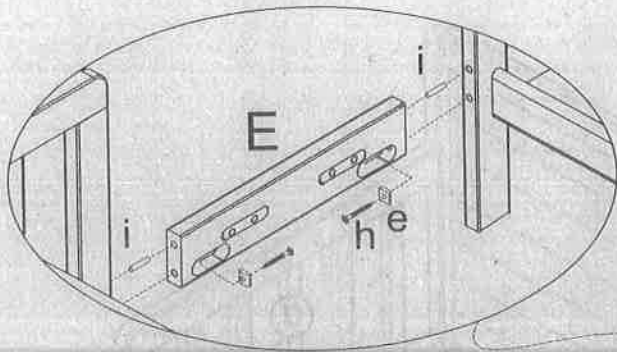

# STEP 1

STEP 2

## Parts and tools required to complete step.

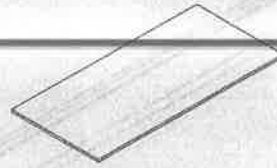
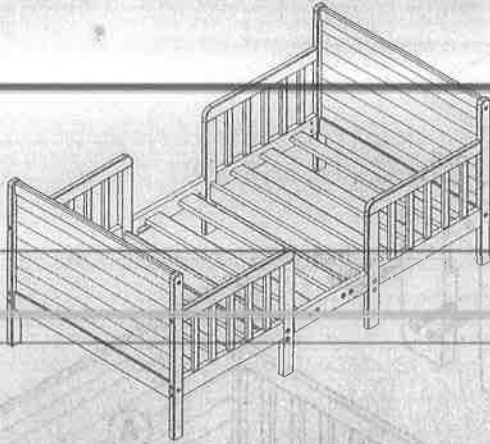

Table top(1pc)  
Not supplied



Legs(4pcs)  
Not supplied



g. Allen wrench (1pc)

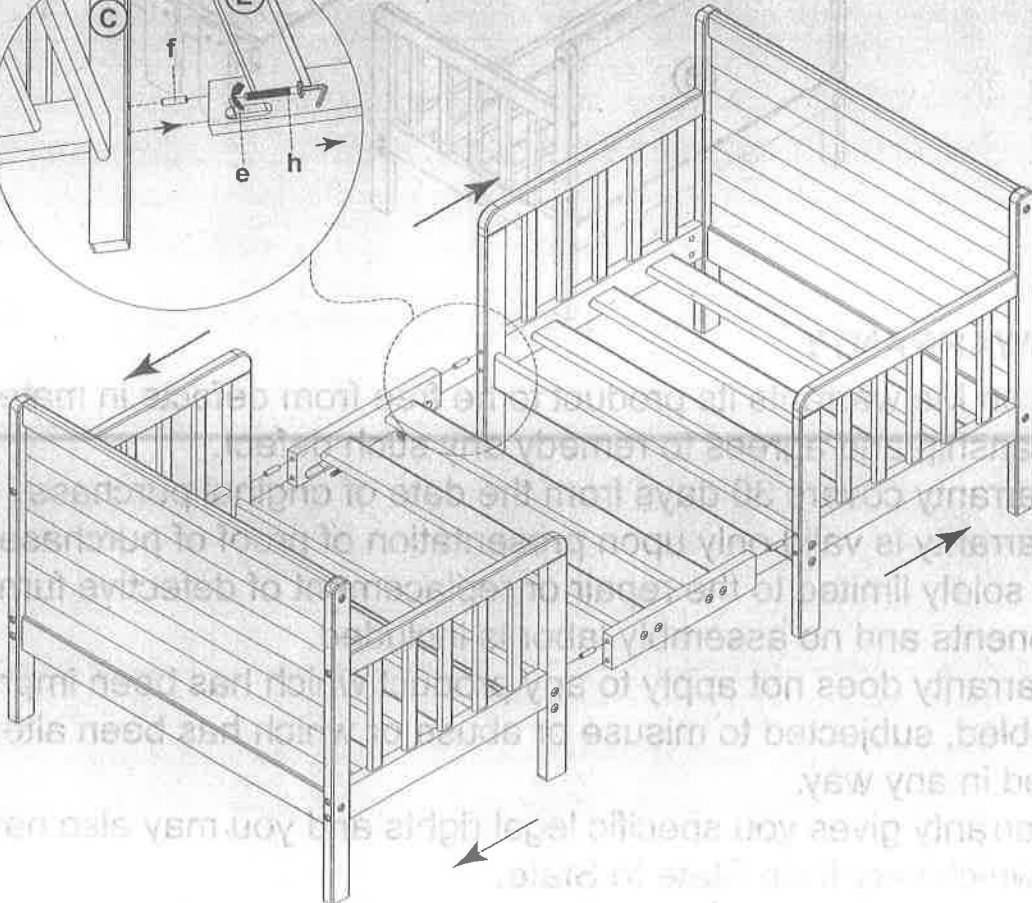
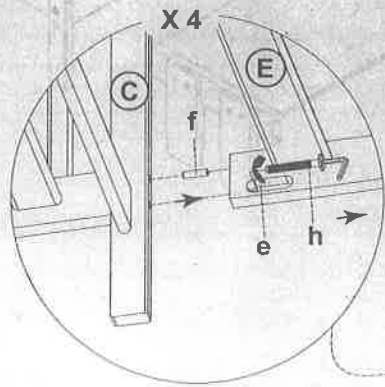

# SECTION 2: Chair and Table Assembly

## STEP 2

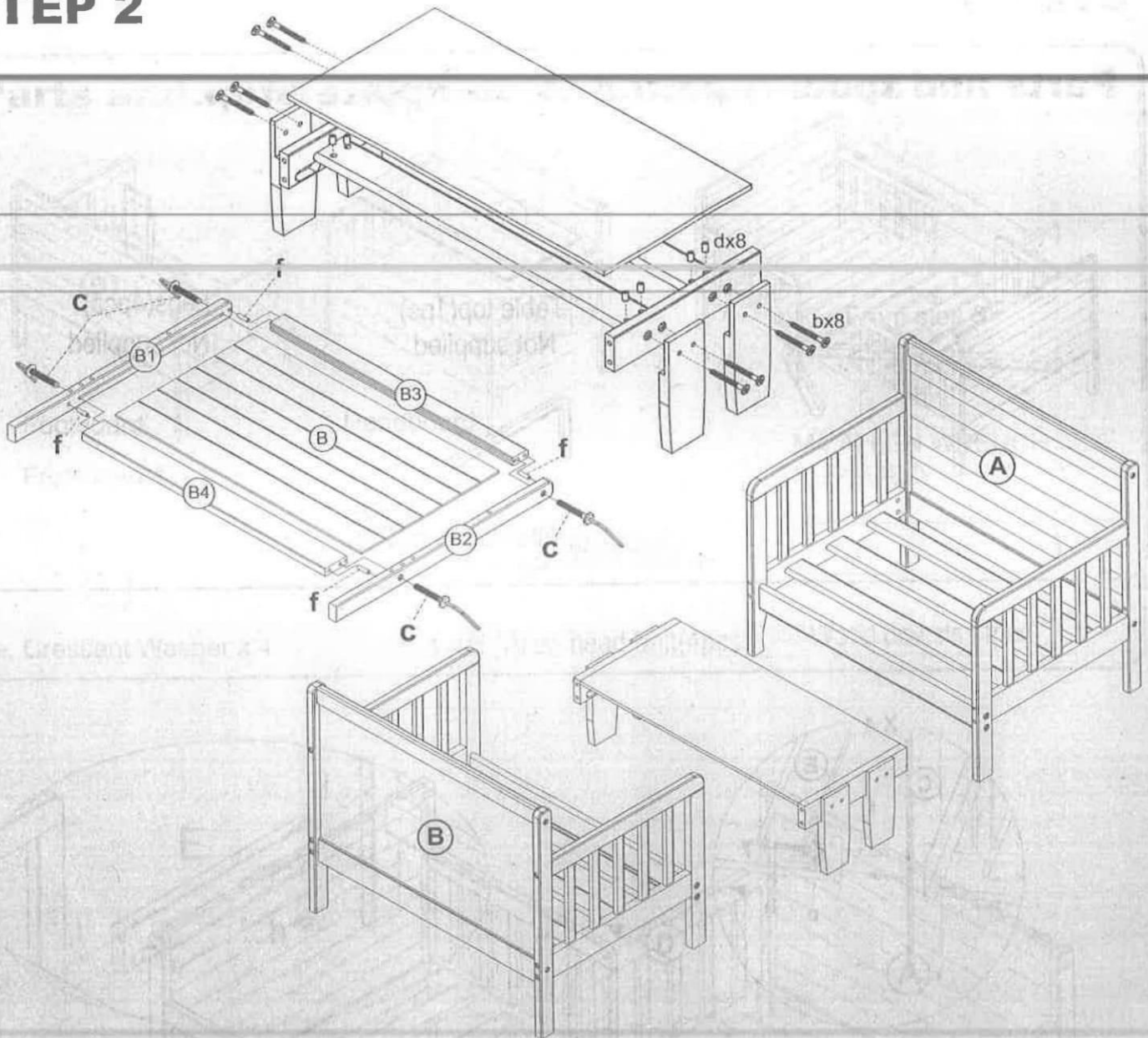

### LIMITED WARRANTY

- We warrant our product to be free from defects in material and workmanship and agrees to remedy any such defect.
- This warranty covers 30 days from the date of original purchase.
- This warranty is valid only upon presentation of proof of purchase. This is solely limited to the repair or replacement of defective furniture components and no assembly labor is included.
- This warranty does not apply to any product which has been improperly assembled, subjected to misuse or abuse or which has been altered or repaired in any way.
- This warranty gives you specific legal rights and you may also have other rights which vary from State to State.

**WARNING:** Should this product become damaged, and/or components are broken or missing, DO NOT USE