











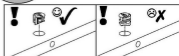
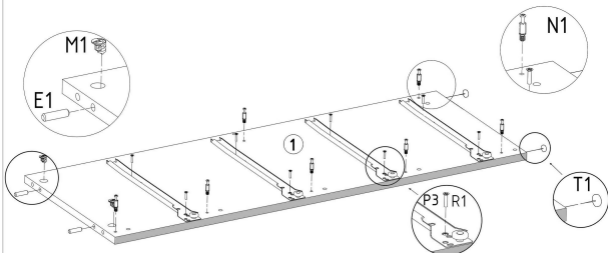

1	x	1
2	x	1
3	x	7
4	x	1
5	x	2

6	x	8
7	x	4
8	x	4
9	x	4

E1	M1	N1	P3	R1	T1					
										
8x30mm	x2	12x15mm	x2	L=35mm	x7	L=350mm	x4	6x8mm	x8	x2



E1	M1	N1	P3	R1	T1					
										
8x30mm	x2	12x15mm	x2	L=35mm	x7	L=350mm	x4	6x8mm	x8	x2

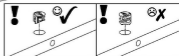
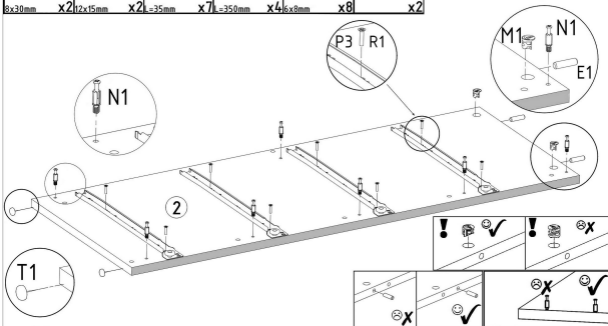

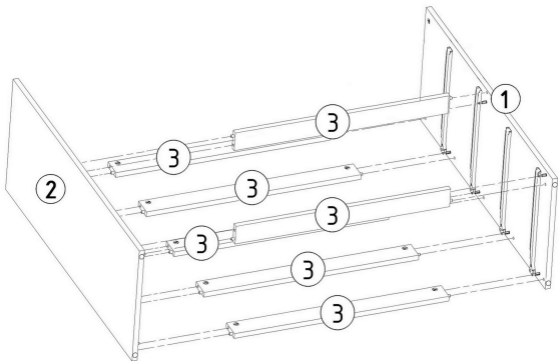
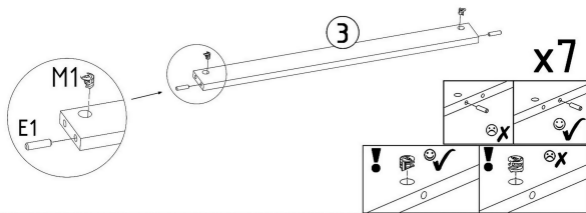
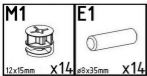

N1



L. 10mm - 25



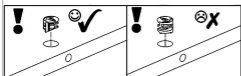
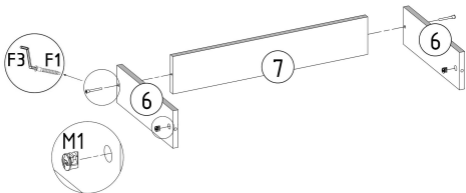
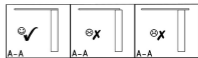
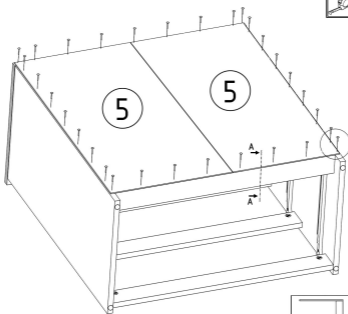
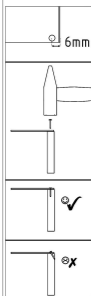
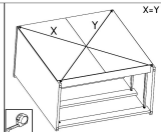

x4

N1



L=35mm x8

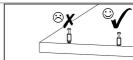
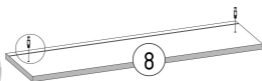

x4

B1

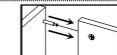
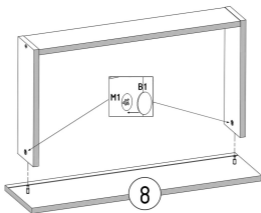
B  
ø17/5-4mm x8

1.



2.

x4

Z1



x24

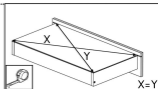
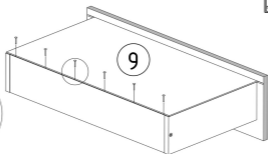

x4

P3



S1



L=350mm x4 3,5x16mm x16

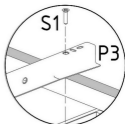
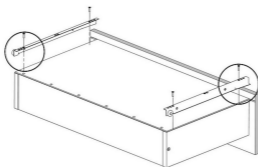
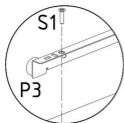

x4

V13



x1



