

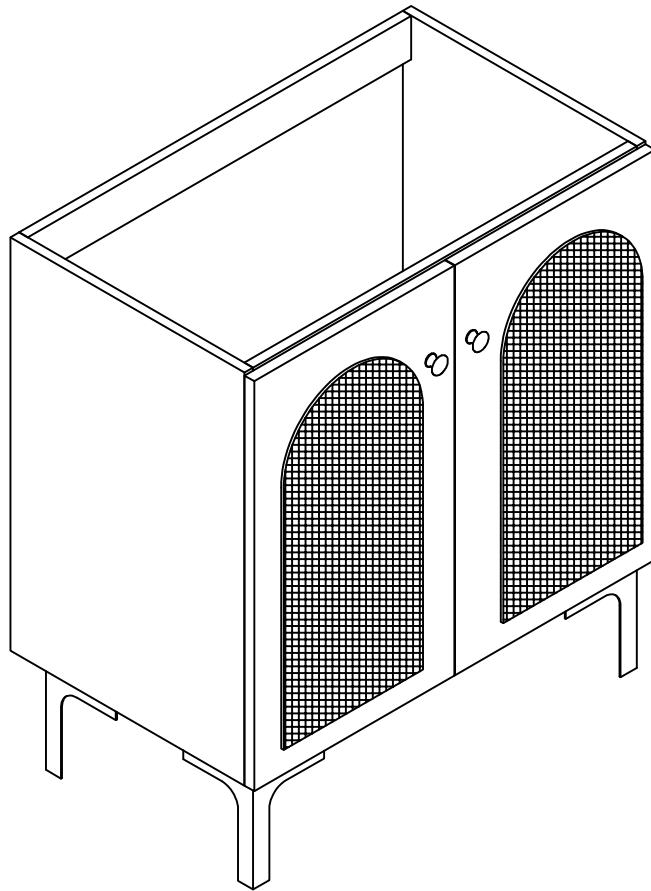

US 129







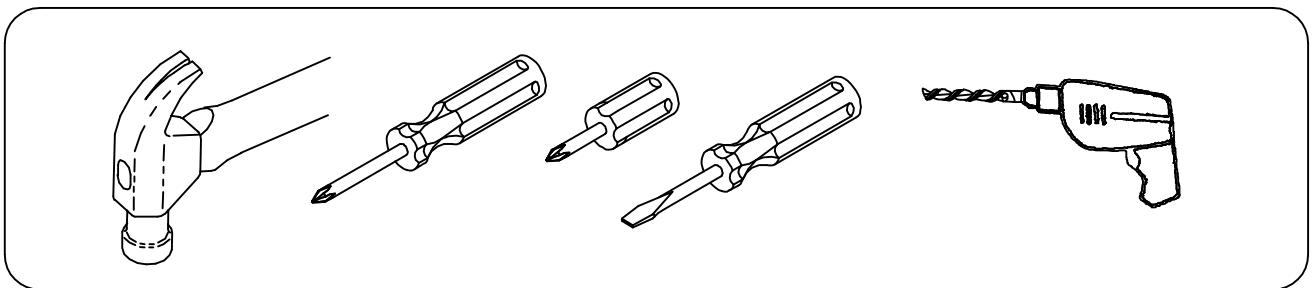



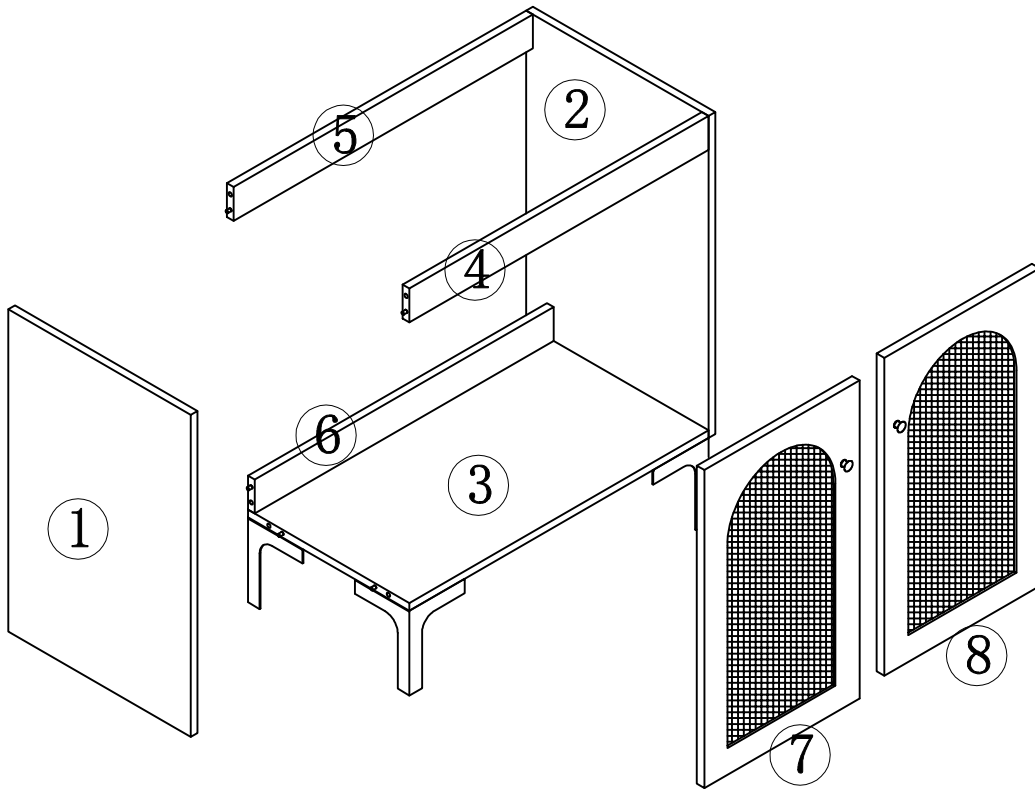





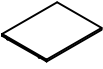



YOU MAY NEED (NOT SUPPLY)



ASSEMBLY DIAGRAM



PARTS LIST					
PARTS LIST					
NO	DESCRIPTION	QTY	NO	DESCRIPTION	QTY
①	Left side panel 	1	⑤	Back fixed panel 	1
②	Right side panel 	1	⑥	Back fixed panel 	1
③	Bottom panel 	1	⑦	Left door panel 	1
④	Front fixed panel 	1	⑧	Right door panel 	1

PARTS LIST					
HARDWARE LIST					
NO	DESCRIPTION	QTY	NO	DESCRIPTION	QTY
A	Three-in-one eccentric wheel 	14	F	Metal feet 	4
B	Three-in-one connecting rod 	14	G	4*16mm screw 	40
C	Three-in-one sticker 	14	H	4*23mm screw 	2
D	8*40mm wood dowel pins 	8	I	Door handle 	2
E	Door hinges 	4			
CAUTION: Please confirm the parts list before installation					

STEP 1

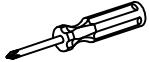
HARDWARE LIST	
Three-in-one connecting rod B  14PCS	

1. Put the three-in-one connecting rod in the 10mm hole of the following panels and tighten them with a cross screwdriver or an electric tool.

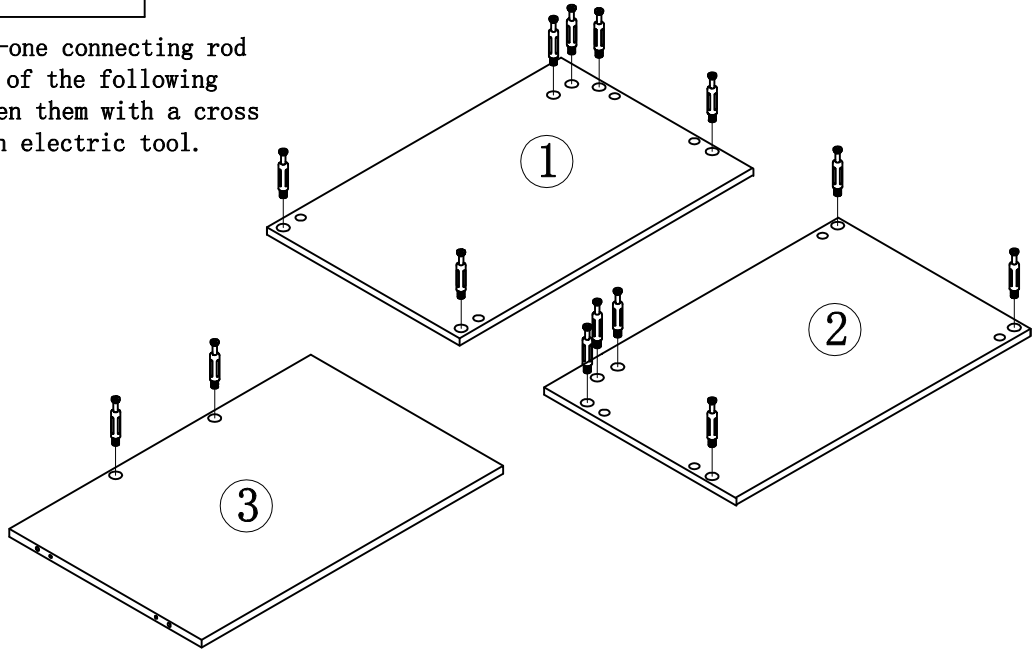
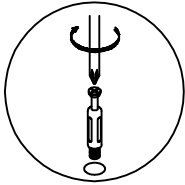

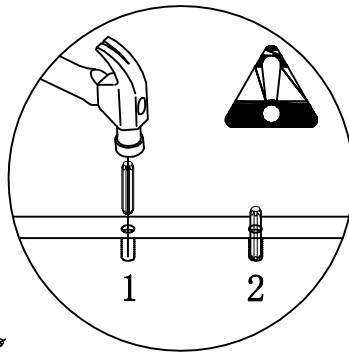

STEP 2

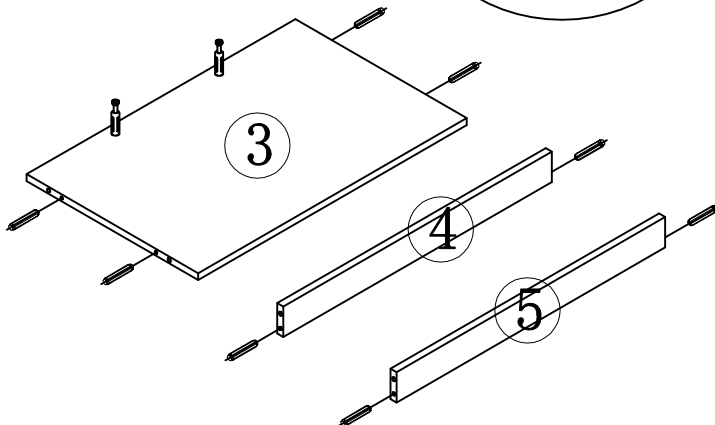

1. Strike the 08*40mm wood dowel pin into the 8mm hole of the above panels with an iron hammer. Please note that the hole of the three-in-one connecting rod should also be 8mm. The hole of the three-in-one connecting rod connects to the hole of 15mm three-in-one eccentric wheel.



HARDWARE LIST	
8*40mm wood dowel pins D  8PCS	

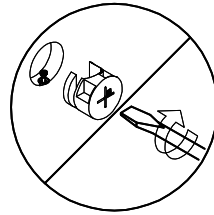
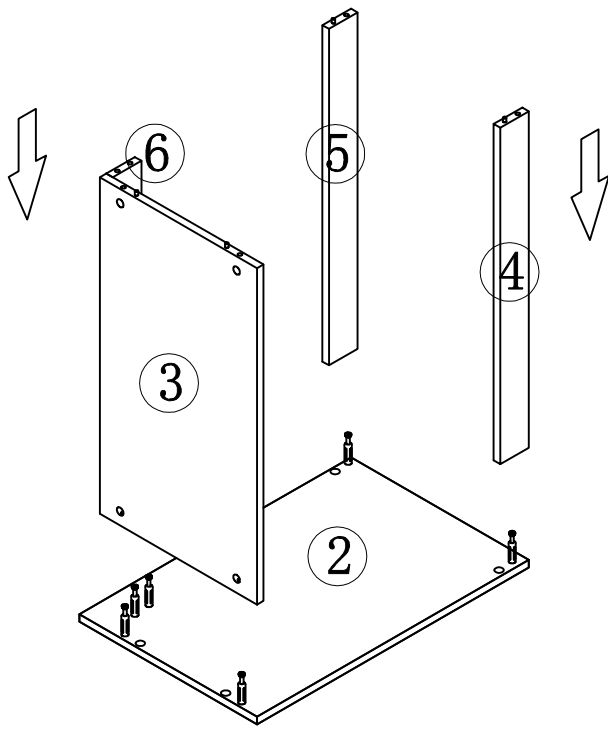

STEP 3

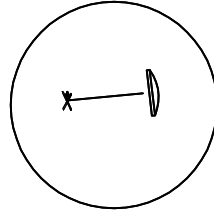

1. Connect No. 3-4-5-6 panel to No. 2 panel tightly with the three-in-one eccentric wheel.



2. Cover the mounting hole of the eccentric wheel with a three-in-one sticker.

HARDWARE LIST		
Three-in-one eccentric wheel A  8PCS	Three-in-one sticker C  8PCS	

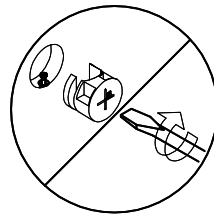
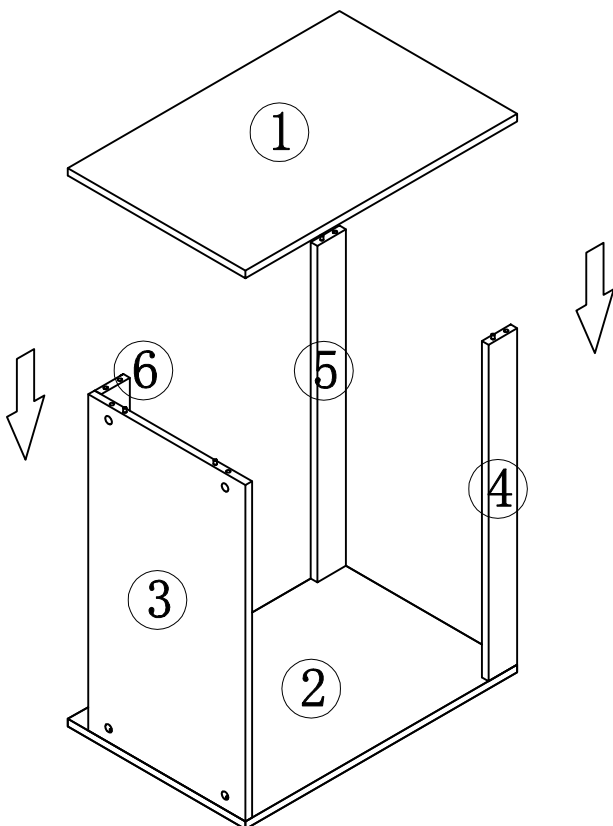

STEP 4

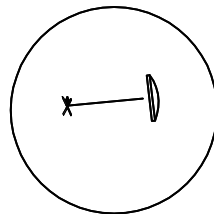

1. Connect No. 1 panel to No. 3-4-5-6 panel tightly with the three-in-one eccentric wheel.





2. Cover the mounting hole of the eccentric wheel with a three-in-one sticker.

HARDWARE LIST		
Three-in-one eccentric wheel A  6PCS	Three-in-one sticker C  6PCS	

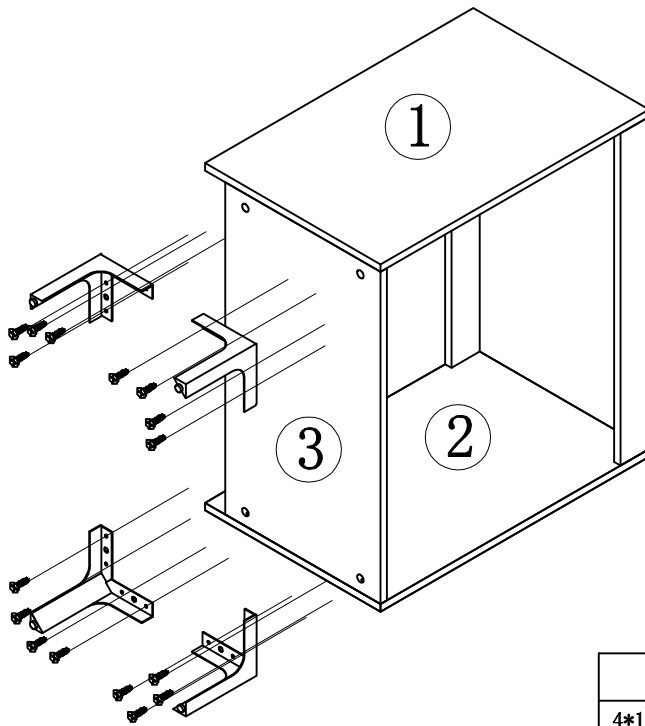
STEP 5



Use 4*16 screws to fix the Metal feet

HARDWARE LIST		
4*16mm screw	Metal feet	
G  16PCS	F  4PCS	

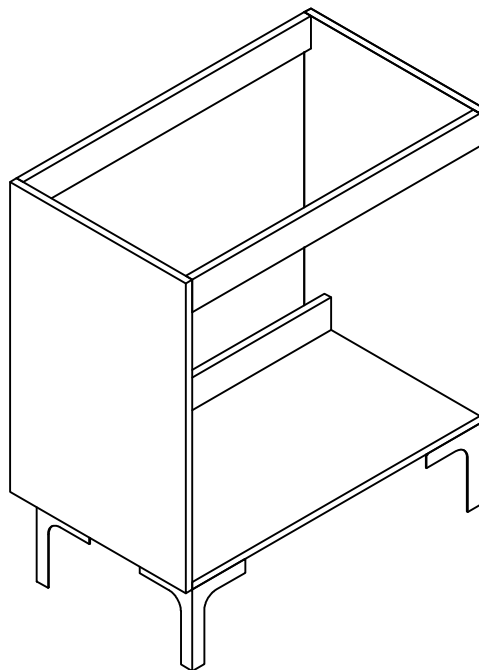

STEP 6

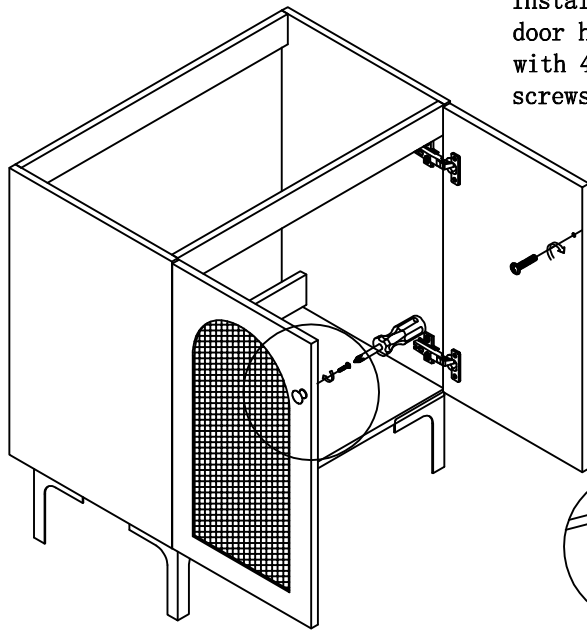

Install the door handle with 4*23mm screws.

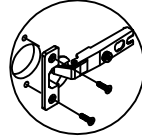

1. Install the hinge cup to the door panel with 4*16mm screws.

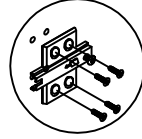

2. Install the hinge to the side panel with 4*16mm screws.

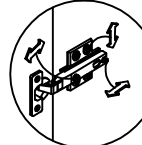

4. Adjust the door panel clearance.

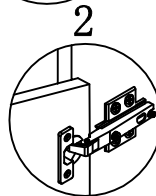
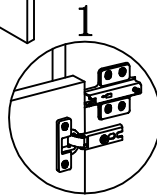

3. Install the hinge cup on the door panel to the hinge of the side panel.

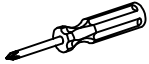
HARDWARE LIST				
4*16mm screw	Door hinge	Door handle	4*23mm screw	
G  24PCS	E  4PCS	I  2PCS	H  2PCS	

Hinge/Door Adjustment and Realignment

If adjustment or realignment is needed, follow the instructions provided in the following chart.

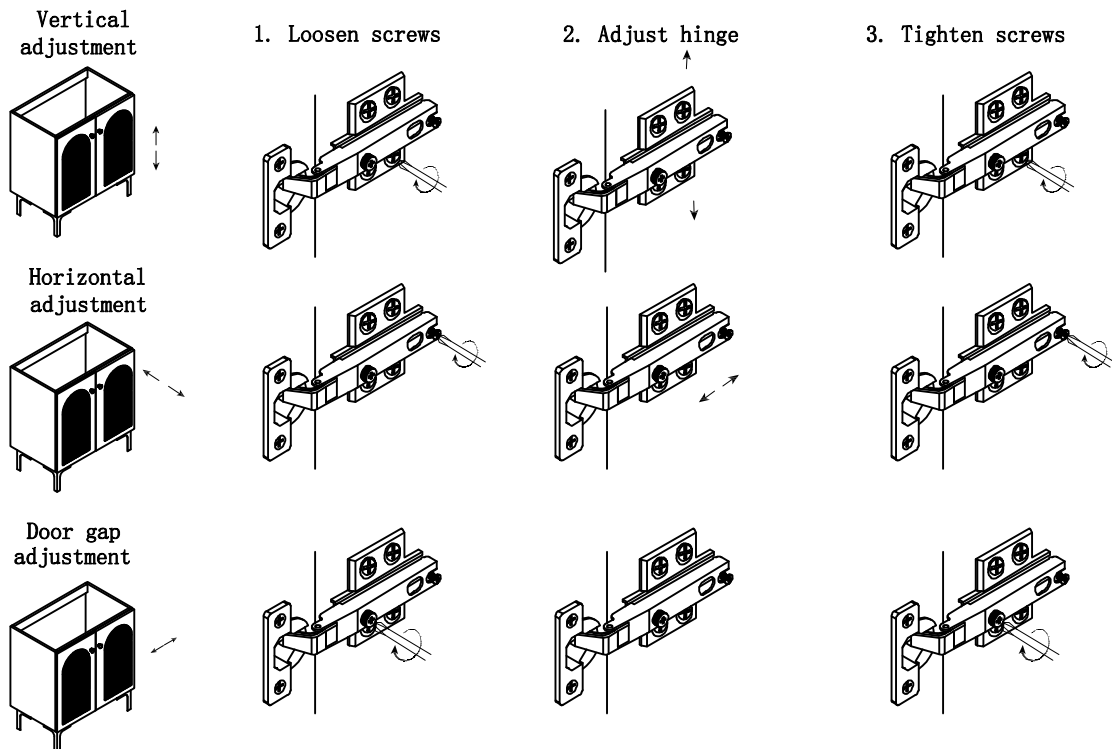



Choking hazard-Small Parts : This unit contains small parts, not for children under 3 years.

Tip-over hazard : Secure finished unit to wall stud using L-Bracket and wall screw (#10*1.5"W/out provided). If a wall stud is not neccessible , Consault your local hardware store for appropriate mounting hardware . Failure to properly install will result in product collapse or tip-over. Serious injury can occur .