

# Assembly Instructions

## THE METHOD TO SET UP

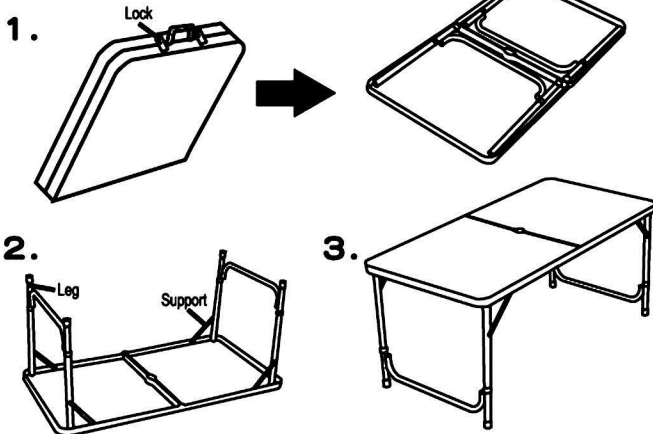

1. Turn the lock outward.
2. Open the legs out from the table and lock the supports, Extend the legs completely until locked into position.
3. Turn outside in and use.

## THE METHOD TO ADJUST THE HEIGHT:

Press pins inwards and pull the legs upwards until locked into position.

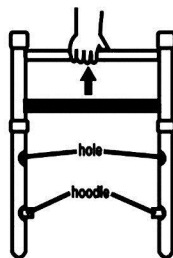

\* When adjusting the height please ensure the table is faced downwards on the level surface.

FORM	
THE DIMENSION WHEN THE LEG IS NOT EXTENDED	Approx. 1200X600X550MM
THE DIMENSION WHEN THE LEG IS EXTENDED	Approx. 1200X600X700MM
BEARING	Approx. 30 KGS
MATERIAL	Table MDF Legs Metal Alu.

## ⚠ WARNING

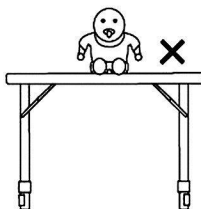

Please do not put children on the table and any hot object, including portable stoves.

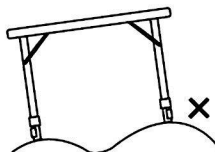

Please put the table on the flat floor.



Please Make sure the support arms are completely open.

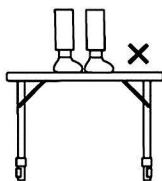

Please don't stand on the table.

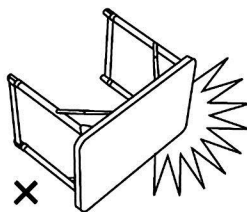

Please don't impact the table.



Table should not left in prolonged rain or extreme sun shine. Table should be stored in a clean and dry area.

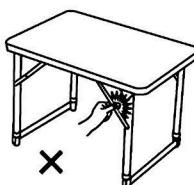

Please be careful of your fingers when opening.

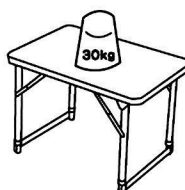

Please kindly note the max weight on the table is 30kgs.

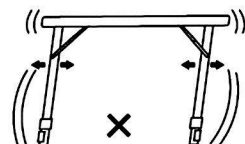

Please don't wobble the table.