

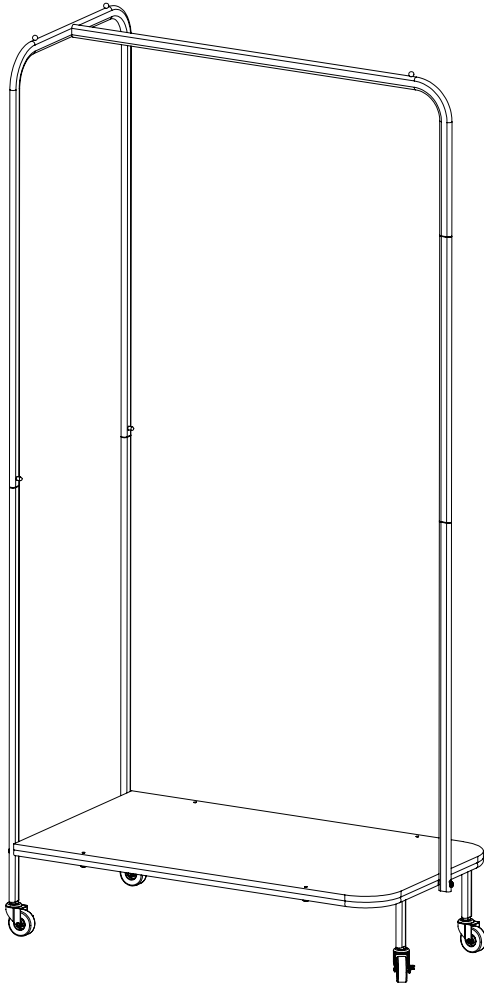









GAR-09851

rolling garment rack





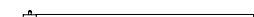



34 in L x 18 in W x 68 in H

PARTS LIST

PART/ILLUSTRATION	(QTY)	DESCRIPTION
A 	(1)	bottom base
B 	(1)	top support bar
C 	(1)	top horizontal support bar
D 	(2)	bottom support legs
E 	(1)	bottom support leg
F 	(1)	middle support leg
G 	(1)	bottom shelf

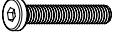
PARTS LIST

PART/ILLUSTRATION	(QTY)	DESCRIPTION
I 	(2)	locking casters
J 	(2)	casters
N 	(1)	wrench
K 	(4)	short hex screws
L 	(4)	long hex screws
M 	(1)	hex wrench

ASSEMBLY

1

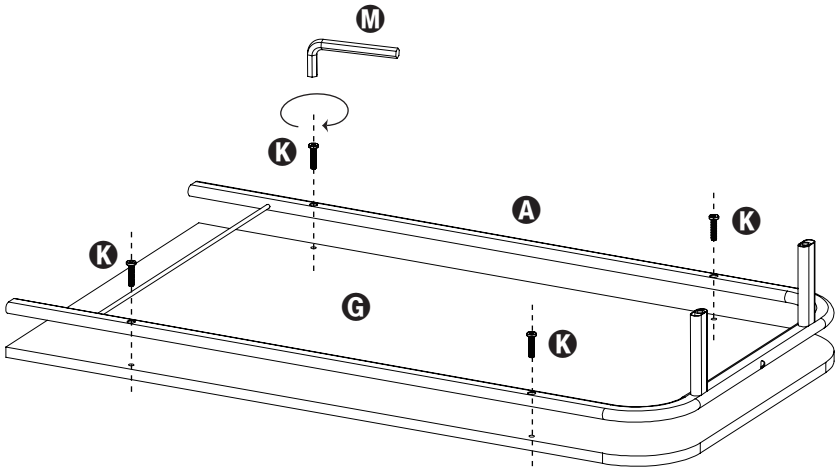

ASSEMBLY

2

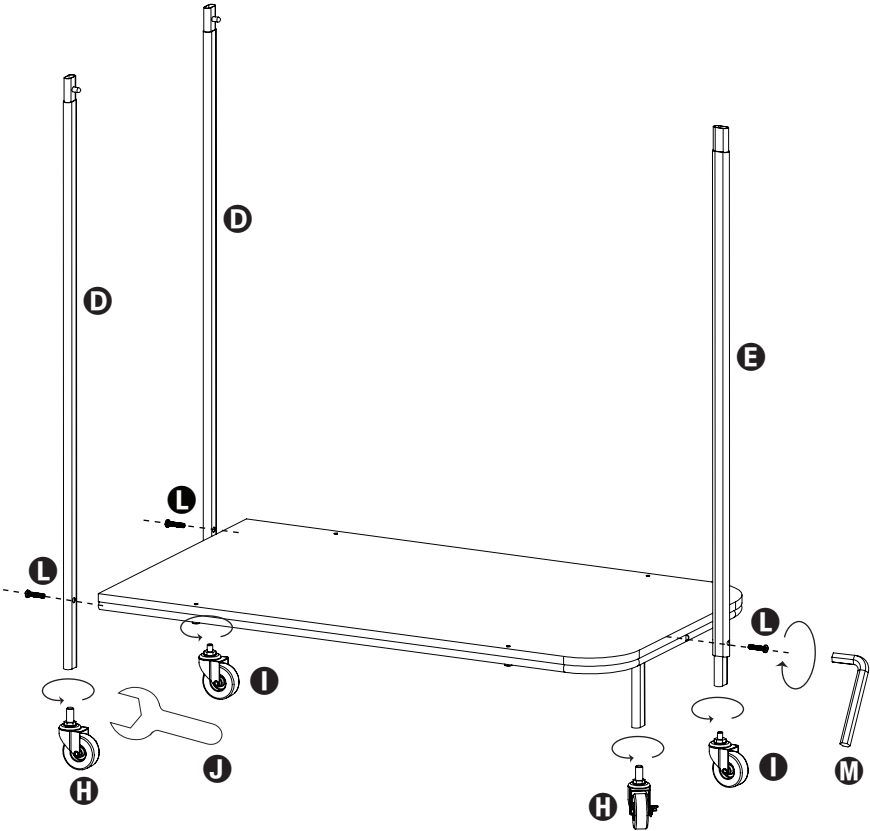

ASSEMBLY

3

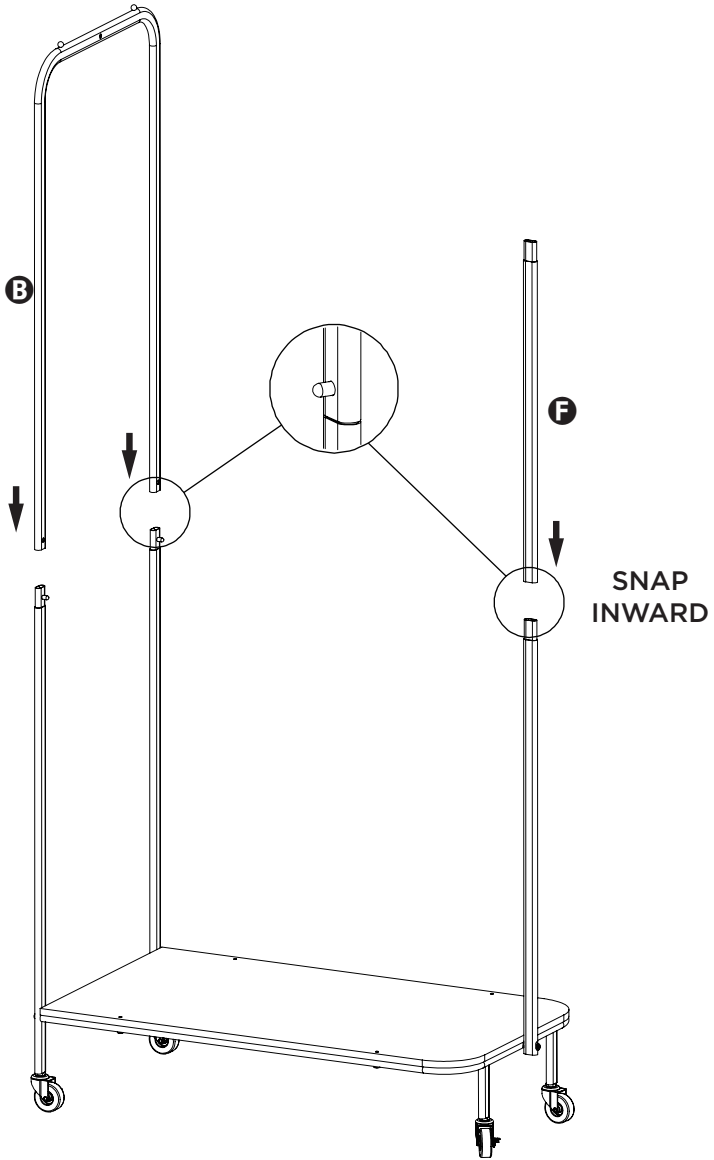

ASSEMBLY

4

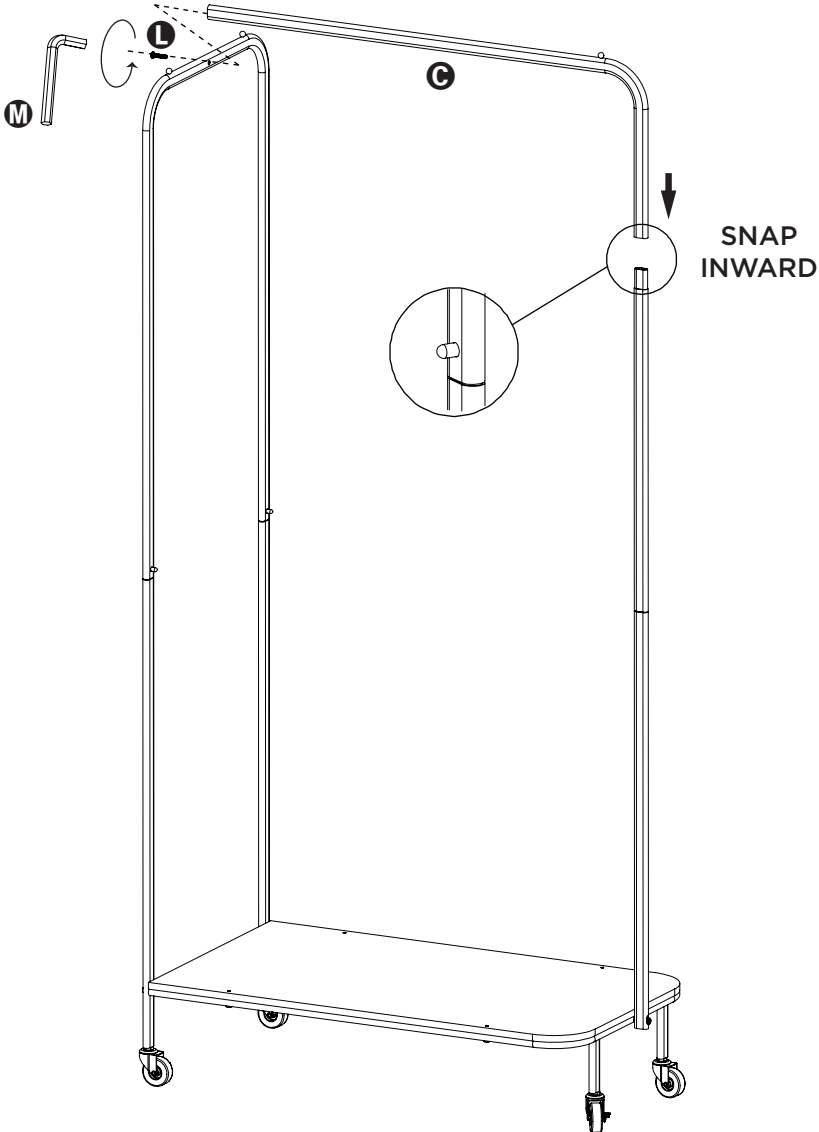



honey•can•do

Honey-Can-Do International

5300 St. Charles Road, Berkeley, IL 60163 USA

877.242.2636 | honeycando.com | support@honeycando.com

©2023 Honey-Can-Do International, LLC | All Rights Reserved

Visit [youtube.com/myhoneycando](https://www.youtube.com/myhoneycando) to watch our assembly videos.