











Kingston Queen Assembly Instructions

Hardware List includes factory installed bolts and washers for side rails attachment.

A	B	D	E	F	G	I	J	R	T
									
φ6*15MM	φ8*30MM	φ6MM	φ8MM	H=10MM		φ8MM		φ8*70MM	φ6*20MM
8PCS	12PCS	12PCS	20PCS	4PCS	4PCS	1PC	4PCS	8PCS	4PCS

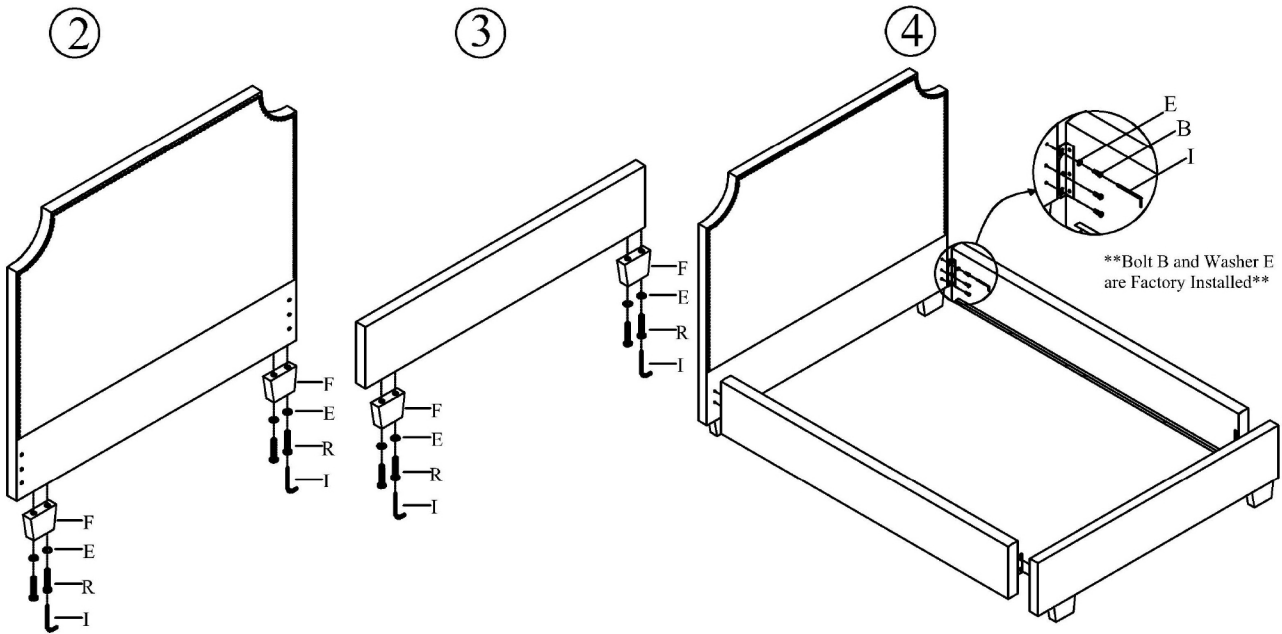

Step#1

Retrieve bed feet and center support legs from zipper behind the headboard.

Step#2

Attach bed feet(F) to the headboard using Wrench(I), Bolt(R), Washer(E).

Step#3

Attach bed feet(F) to the footboard using Wrench(I), Bolt(R), Washer(E).

Step#4











Attach side rails to headboard and footboard using Wrench(I), Bolt(B) and Washer(E).

CONGRATULATIONS ON YOUR NEW BED PURCHASE

~Warning:do not move bed after final assembly as it may result in damages to floor and/or bed.~

Kingston Queen Assembly Instructions

Hardware List includes factory installed bolts and washers for side rails attachment.

A	B	D	E	F	G	I	J	R	T
									
φ6*15MM	φ8*30MM	φ6MM	φ8MM	H=10MM		φ8MM		φ8*70MM	φ6*20MM
8PCS	12PCS	12PCS	20PCS	4PCS	4PCS	1PC	4PCS	8PCS	4PCS

⑥

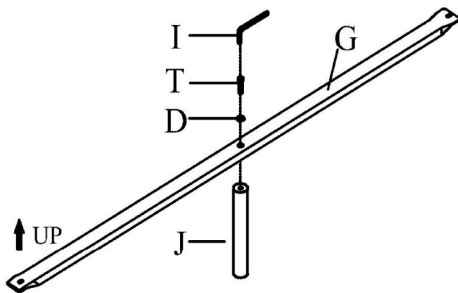

⑦

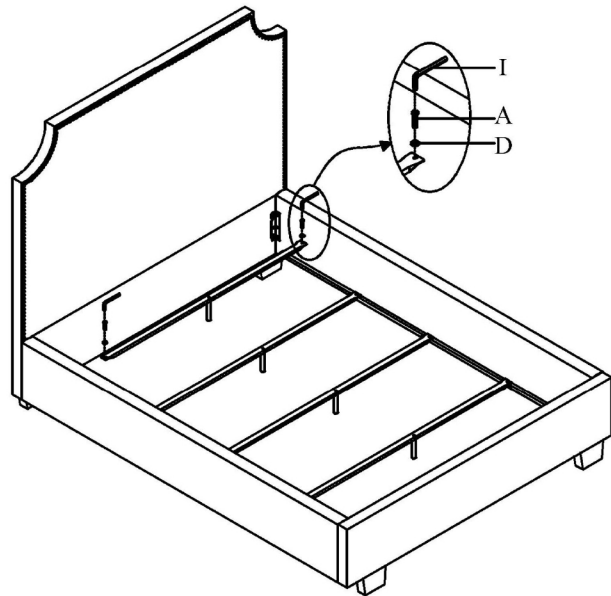

Step#5

Move/place bed into final position in bedroom.

Step#6

Attach steel center support legs(J) to the Metal slat(G) using Wrench(I), Bolt(T), Washer(D).

Step#7

Attach steel slat support system to full length steel side rail support cleats (flat side facing up).

Verify the metal slats are inserted properly into support cleats and center support legs are perpendicular to the floor for full support.

CONGRATULATIONS ON YOUR NEW BED PURCHASE

~Warning:do not move bed after final assembly as it may result in damages to floor and/or bed.~