

Folding Wireless Adjustable Base
OWNER'S MANUAL Installation & Operation



Patent Pending

2-Year Parts and Labor on entire base
Warranty.

Table of Contents

Safety & Warranty Warnings	01
Parts List	06
Electronics Quick Reference Guide	07
Electronics Quick Reference Guide	09
Installation Guide	11
Remote Control Instructions	13
Remote Control Instructions	15
Pairing Remote and Setting Programmable Positions.....	17
Emergency Battery Backup	18
Synchronizing Two Bases	19
Headboard Bracket Installation Guide	21
Tandem Bracket Installation	22
Troubleshooting	23

Safety & Warranty Warnings

Attention: Read the following information before using this product . Failure to use a surge protection device could compromise safety or cause product malfunction and could void the electrical portion of your warranty.

Electrical surges are by far the biggest cause of problems with electrical circuits.

In order to help protect your investment in case of a power surge or outage, use an electrical surge protection device (not included).

WARRANTY WARNING!

Do not open or tamper with the transformer, control box, motors, or remote control (with the exception of battery compartments). The product warranty will be void if these components are tampered with.

SMALL CHILDREN AND PETS:

Immediately dispose of all packing materials as they can smother small children and pets. Do not allow any persons or pets under the bed. Children, convalescents and disabled person should not operate the bed without adult supervision.

HOSPITAL OR CONVALESCENT USE DISCLAIMER:

Adjustable beds are designed and engineered for a life style of in-home comfort and are not intended for hospital use or for a bed-ridden patient on an extended recovery. Adjustable beds are not equipped with bars to help patients get safely in and out of bed and are not intended to be used around tent type oxygen therapy or explosive gases.

PACEMAKER WARNING:

The massage units in this bed produce mechanical vibrations that this warranty; (d) to damage to mattresses, fabric, cables, electrical cords or items supplied by dealers. Contact the dealer for warranty information on these items; (e) if there has been any modification of the adjustable bed without prior written consent by Mlily; (f) to costs for unnecessary service calls, including costs for in-home service calls solely for the purpose of education the consumer about the adjustable bed or finding an unsatisfactory power connection; (g) if the recommended weight restriction is not followed (refer to the advisory section of this manual), the warranty will be void. Repairs to or replacement of an adjustable bed or its components under the terms of this limited warranty will apply to the original warranty period and will not serve to extend such period. The decision to repair or to replace defective parts under this warranty shall be made, or cause to be made, by Mlily at its option and in its sole discretion. Repair or replacement shall be the sole remedy of the purchaser. There shall be no liability on the part of Mlily for any special, indirect, incidental, or consequential damages or for any other damage, claim, or loss not expressly covered by the terms of this warranty. This limited warranty does not include reimbursement for inconvenience, removal, installation, setup time, loss of use, shipping, or any other costs of expenses, Mlily and/or its service technicians shall not be responsible for moving furniture or any other items not attached to the adjustable bed in order to perform service on the adjustable bed. It is the sole responsibility of the purchaser to provide adequate space and accessibility to the adjustable bed. In the event that the technician is unable to perform service due to lack of accessibility, the service call will be billed to the purchaser and the service will have to be rescheduled. Mlily makes no other warranty expressed or implied, and all implied warranties of merchantability and fitness for a particular purpose are disclaimed by Mlily and excluded from this agreement. Some states do not allow the exclusion or limitation of incidental or consequential damages, so the above limitation or exclusion may not apply to every purchaser. This warranty gives the purchaser specific legal rights, and the purchaser may also have other rights, which may vary from state to state.

This warranty begins on the “warranty commencement date” which is the date of purchase for new unused beds and the date of manufacture for beds that have been used as floor or display models.

1ST & 2ND YEAR FULL WARRANTY

For the 1st and 2nd year from the Warranty Commencement Date, your adjustable base is warranted against non-excluded defects in Mlily’s workmanship or materials. During the 1st and 2nd year from the Warranty Commencement Date, Mlily will repair or replace (at no cost to You) any defective adjustable base part, and Mlily will pay all authorized labor associated with the repair or replacement of any parts found to be defective. In the case where adjustable base needs to be replaced Mlily does not cover or pay for any part of transportation costs.

ADDITIONAL TERMS AND CONDITIONS

This warranty does not apply; (a) to any damage caused by the purchaser; (b) if there has been any repair or replacement of adjustable bed parts by an unauthorized person; (c) if the adjustable bed has been mishandled (whether in transit or by other means), subjected to physical or electrical abuse or misuse, or otherwise operated in any manner inconsistent with the operation and maintenance procedures outlined in the Owner’s Manual and may activate a special sensor in your pacemaker that detects motion. This can fool the pacemaker into “thinking” you are engaged in some sort of physical activity and require a faster heart rate. You may experience a sensation similar to when you are exercising. Consult your physician for further information.

PRODUCT RATINGS:

The bed lift motors are not designed for continuous use of more than 2 minutes in an 18 minutes period, or approximately 10% duty cycle. Any attempt to circumvent or exceed this rating will shorten the life expectancy of the product and may void the warranty.

WEIGHT UNITS:

The limitation for this adjustable bed is 850 lbs. The bed will structurally support these weights, provided weight is evenly distributed across the head and foot sections. This product is not designed to support or lift this amount in the head or foot section alone. Exceeding this weight restriction could damage the bed and/or cause injury and void the warranty. Enter or exit the bed in a flat position and do not sit on the head or foot sections while in the raised position.

LIFTING AND LOWERING MECHANISMS AND MASSAGE UNITS:

It is normal for the raising and lowering feature on this bed to emit a minimal humming sound during operation. The massage feature creates a vibrating hum during operation and the resonance will increase accordingly with a higher intensity motor setting.

LOCATION ENVIRONMENT:

The level of sound experienced in a room is directly related to the environment within that location. In a room with hardwood floors and the massage units turned on, a vibrating noise can be noticeable. To reduce the resonance, place a piece of carpet or rubber casters cups under the legs. The rubber caster cups also prevent the bed sliding when located on smooth or hard surface flooring.

TO REDUCE THE RISK OF SHOCK, BURNS, FIRE OR INJURY:

Make sure the base is in a flat position and the vibrating motors are turned off before unplugging the bed base from the power source. Always unplug the base from the electrical outlet before cleaning or servicing the base . If the cord or plug is damaged, discontinue use of the bed base. Contact a qualified service personnel for examination and repair.

FCC COMPLIANCE:

This device complies with part 15 of the FCC Rules for residential use. Operation is subject to the following two conditions: (1) This device may not cause harmful interference, and (2) this device must accept any interference received, including interference that may cause undesired operation.

Radio Frequency: 2.4 GHz

Parts List

All electronics and components that need to be installed are located in boxes under the foundation or attached to the frame. Before discarding the packing materials, ensure that all the parts are accounted for.

A



AAA Batteries (3)
& Remote Control (1)

B



5"+7" legs & Bottom Caps (6pcs)

C



Power Cord (1)
& Power Supply (1)

D



Retainer Bar (1)
2pcs for Cal King/King sizes only
Attached to the bed frame

E



Splitter Cable(1)
For TXL/CKS Only

F



Tandem Bracket (1)
For TXL/CKS Only

Electronics Quick Reference Guide

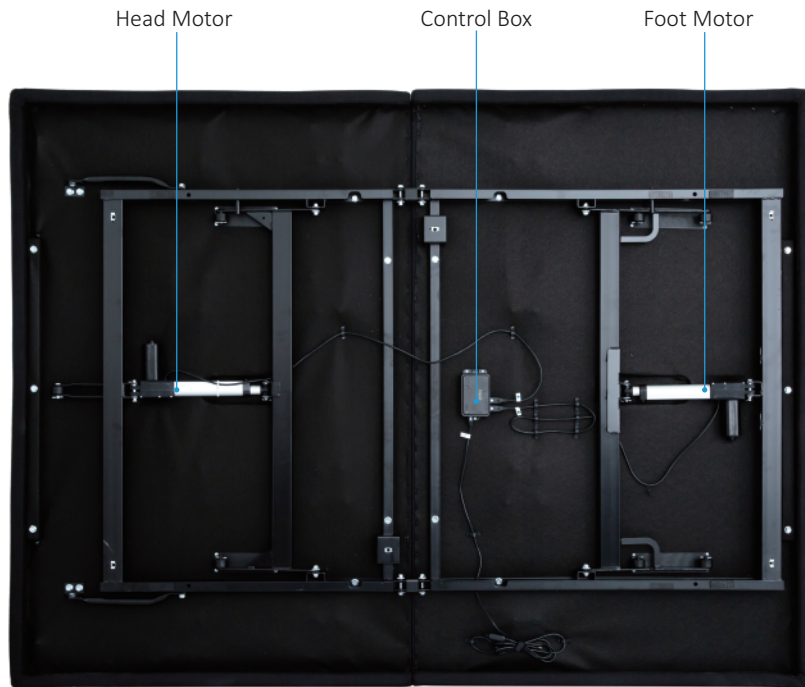



Remote

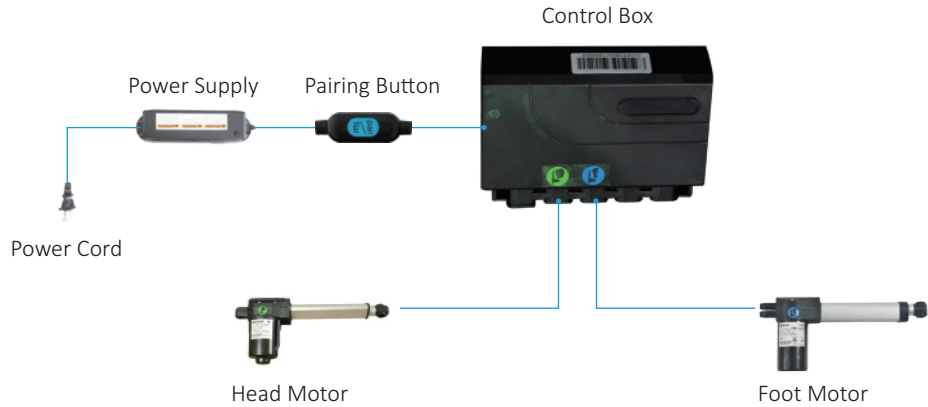

Electronics Quick Reference Guide

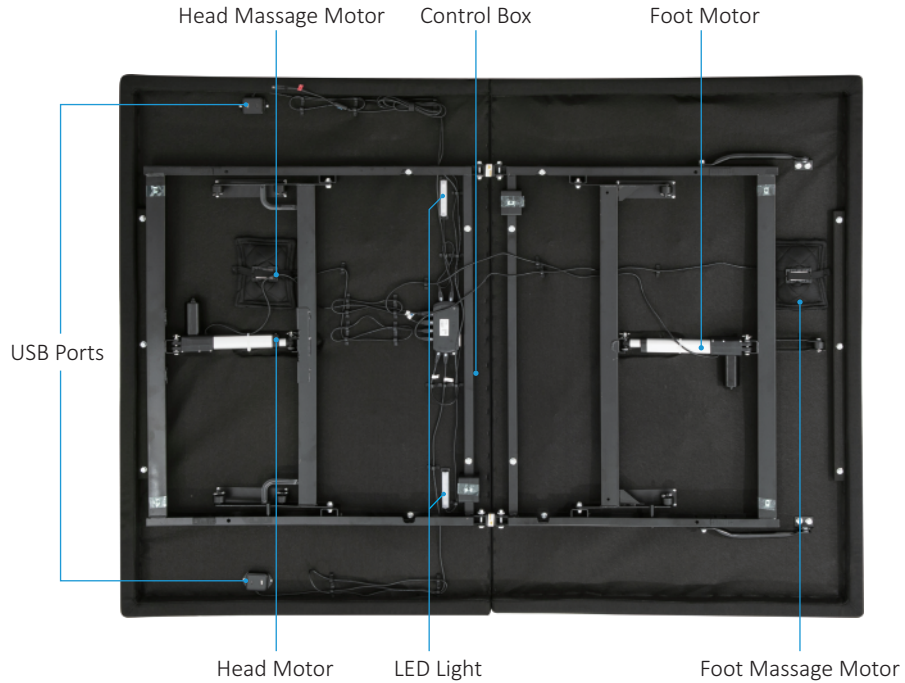

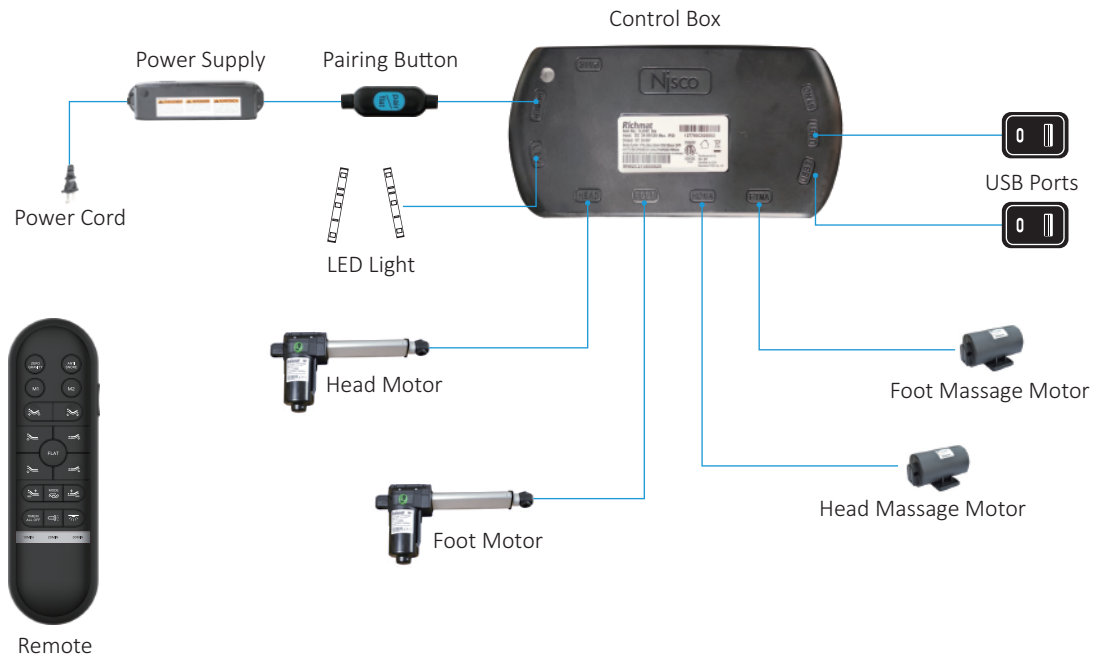

Installation Guide

Two people are required to set up the foundation.

NOTE: To avoid damage to the foundation, always open the carton while the bed is in the flat position.

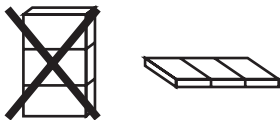

1. Open the shipping box, cut the ribbon securing accessory boxes & mattress retainer bar, and put them aside. Lift the folded bed frame unit out of the shipping carton carefully, and then put it on a flat floor.



2. To install all six legs (seven for king/CK size, see image A on page 12), thread the bolt of the leg to the nut on the foundation frame, and tighten by hand. **DO NOT OVERTIGHTEN.**



3. Uncoil the input power cord (connected to the control box's power port) and plug it into the power supply.



4. Uncoil the power cord and connect it to the power supply.



5. Carefully flip the foundation over onto its legs.

Important: Two people are required to move the foundation. Do not drag across the floor. Do not rest frame on its side; excessive pressure may damage the legs.

6. Ensure that batteries are correctly installed.



7. Locate the mattress retainer bar brackets.

Slide the left side of the mattress retainer bar into the bracket. Pull the retainer bar to the opposite bracket and secure the right side.

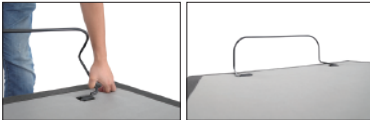

8. Locate the side retainer bar (Optional, not included). Insert side retainer bars into the quick connect brackets located at the sides of bed head.



A

Head

Leg Positions

Foot

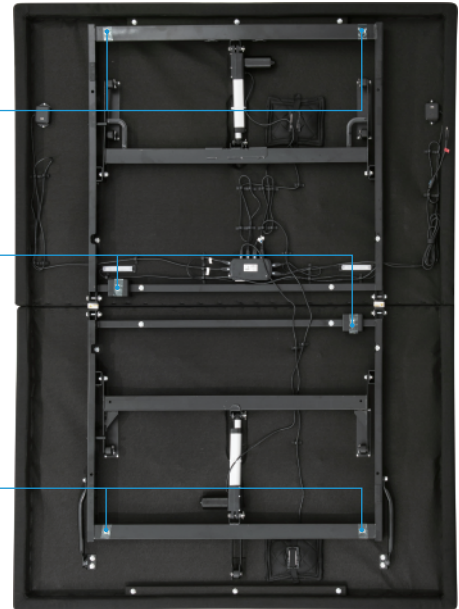

MS200 Remote Control Instructions

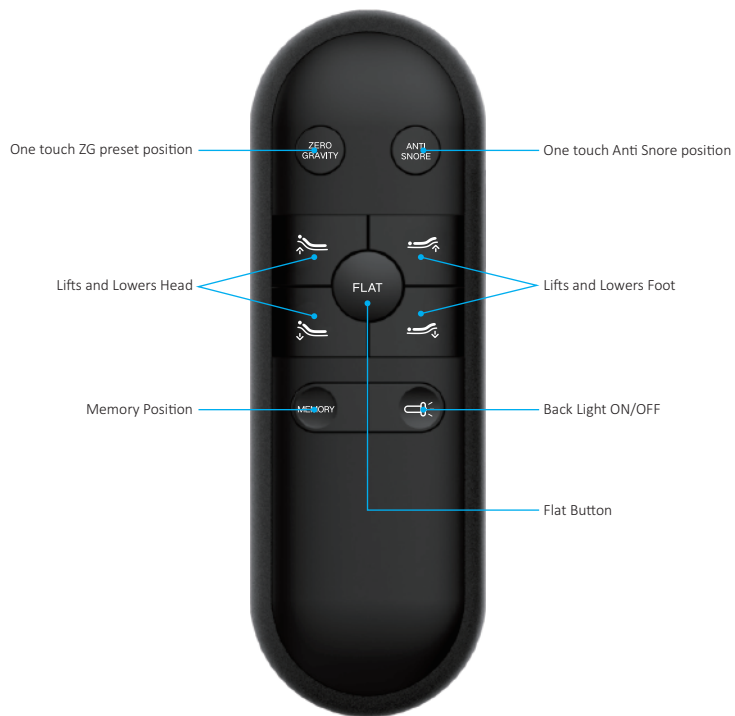

ADJUST



The HEAD▲▼ arrows lift and lower the head section of the base.



The FOOT▲▼ arrows lift and lower the foot section of the base.



ONE TOUCH BUTTONS



Flat Button



Memory Positions



One touch ZG preset position.



One touch Anti Snore position



One touch back light on/off

Remote Control Instructions

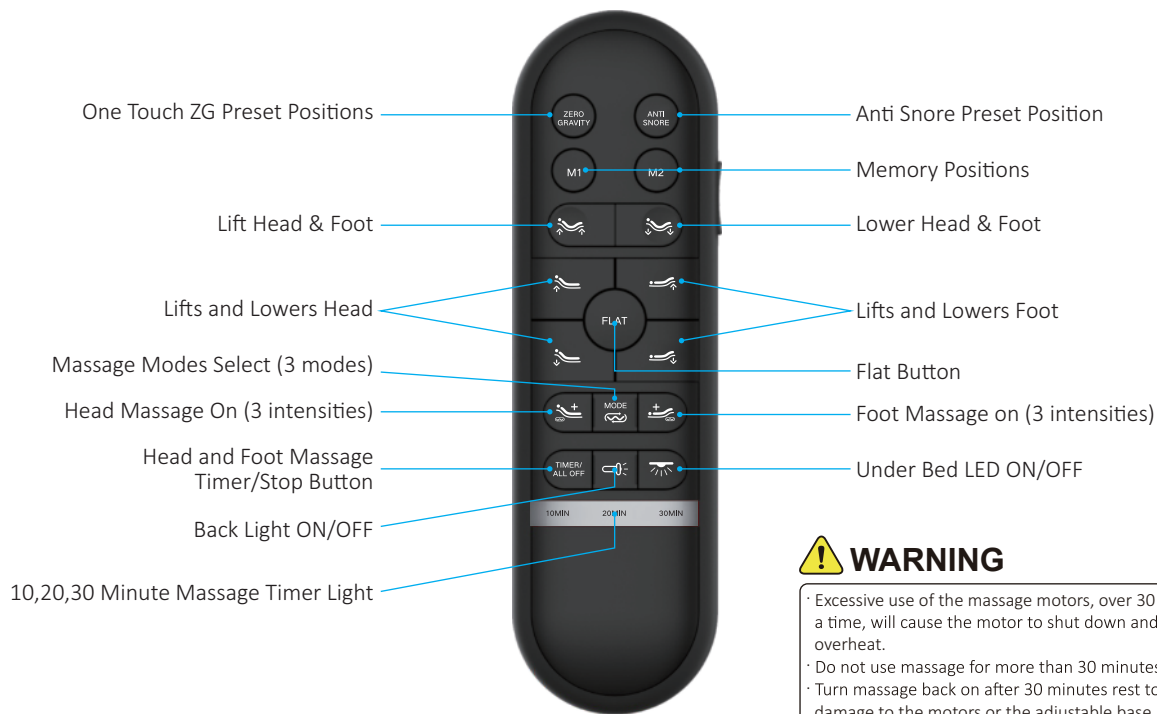

ADJUST



Lifts and Lowers Head



Lifts and Lowers Foot



Lift Head & Foot



Lower Head & Foot



Press and hold the button, back light will be on.

ONE TOUCH BUTTONS



Anti Snore Anti Snore Preset Position



One Touch ZG Preset Positions



Flat Button



Memory Positions



Under Bed LED ON/OFF

MESSAGE FEATURE



Head Massage On (3 intensities)



Foot Massage on (3 intensities)



Massage Modes Select (3 modes)



The button will select a 10, 20 or 30 minute setting. Pressing a fourth time will turn off massage.

10 MIN 20 MIN 30 MIN

The light on the top of the remote indicates a 10, 20 or 30 (backlit of 10&20 MIN on) minute timer setting.

Pairing Remote and Setting Programmable Positions

PAIRING REMOTE

The original remote that comes in the box is already paired to the foundation. No further action is required.

In the event that the remote is not paired with the foundation, follow the steps below.



STEP 1

Make sure the batteries work fine. Replace them when needed.



STEP 2

Plug the power cord to the power source.

STEP 3

Press and hold head lift and foot lift simultaneously, then press and hold the button on the cord of control box for 3 seconds until you hear 2 beeps sound, the remote is then paired.



SETTING PROGRAMMABLE POSITIONS

The wireless power bed has a programmable feature that allows you to save custom positions.

Please read all the instructions below before setting your custom presets on the remote.



STEP 1

Adjust the head and foot to your desired position.



STEP 2

Press and hold the flat button **FLAT** first, then press and hold memory button **M1** **M2** for 5 seconds until you hear 2 beeps sound.

STEP 3

To adjust the saved position, repeat steps 1 and 2 and the new position will be saved.

Emergency Battery Backup

Overview

Important: The backup battery is only to be used in case of a power outage. Batteries are not to be used for normal operation of the bed. The backup battery will not support repeated movement for an extended period of time.

Backup Battery Use:

Use two 9V batteries only (not included). If a power outage occurs, install the 9V batteries into the power supply to allow temporary power to the base (see image A).

Installing Batteries:

Unplug the power cord from the outlet and remove the cover from the compartment on the underside of the power supply (see image B). Place two 9V batteries inside, close the cover and plug the power cord back into the wall outlet. The backup battery will not support repeated movement for extended periods of time. After power is restored, unplug power cord, remove the batteries, then plug the power cord back into the wall for normal use.

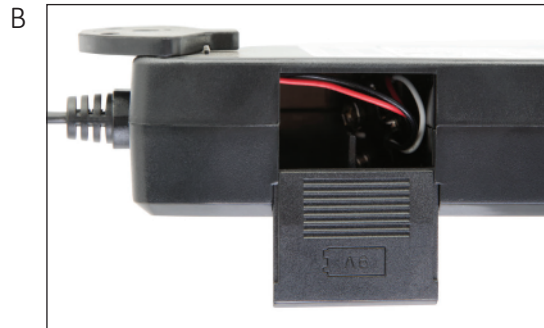

Synchronizing Two Bases

FOR TXL, CKS, BASES ONLY

STEP 1

Plug A and B bases into power source.



STEP 2

Make sure remote A was already paired to Base A and remote B was paired to Base B. If not, please pair them by following the pairing remote instructions on page 17.

STEP 3

Pair remote A to Base B, then base A and base B can be simultaneous operated by remote A.

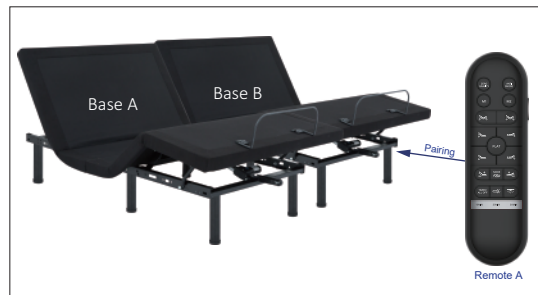

STEP 4

Note: If you want to operate the beds separately, please pair one of the base with A or B remote.

Synchronizing Two Bases

STEP 1

Plug A and B bases to power source.

STEP 2

Make sure remote A was already paired to Base A and Remote B was paired to Base B. If not, please pair them by following the pairing remote instructions on page 17.

STEP 3

Plug Sync Cable (see image A) into the "SYNC" input on the each of control boxes(see image B) .

Now, you can operate the two bases simultaneously using either Remote A or Remote B.

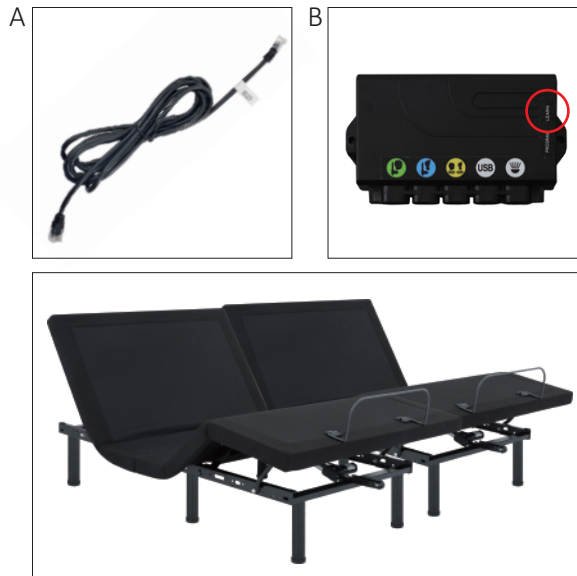

Headboard Bracket Installation Guide

Headboard brackets are an optional accessory and are not included.

A 1/2" (13 mm) socket and 1/2" (13 mm) crescent wrench are necessary to complete installation.

HEADBOARD BRACKET COMPONENTS

(2) Headboard Brackets



(2) T-Brackets

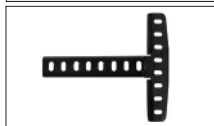

(12) Short Bolts



(12) Nuts



STEP 1

The headboard bracket will have 2 long slots to accommodate any frame type. Align the appropriate slots on the bracket with the holes on the bed. Use bolts and nuts to secure the bracket. Make sure the bolts are tight.



STEP 2

To put the T-Bracket and Headboard Bracket together, you will need (2) bolts and (2) nuts. Slip the bolts through the holes from T-Bracket to Headboard Bracket with the head of bolt facing outward. Use 1/2" (13mm) socket and 1/2" (13mm) wrench to tighten the bolts.



STEP 3

You may now connect your headboard to the attachment plates using your bolts and nuts to secure it to the brackets. The heads of the bolts will face outward. Use a 1/2" (13 mm) socket and 1/2" (13 mm) wrench to tighten the bolts.

Tandem Bracket Installation

King & Cal King only

1. When you want to make a King (or Cal King) size using two TXL (or CKS) beds, you will need the straps (included in the box) to secure the two bases together as one.



2. Put the two beds together. Use the straps to connect the legs of head and foot. Two people are required to lift the foundation while a third one loosens the legs of the two beds. Insert the straps above the legs (strap goes between the frame and the leg) and then use hand to tighten the legs. As shown below:

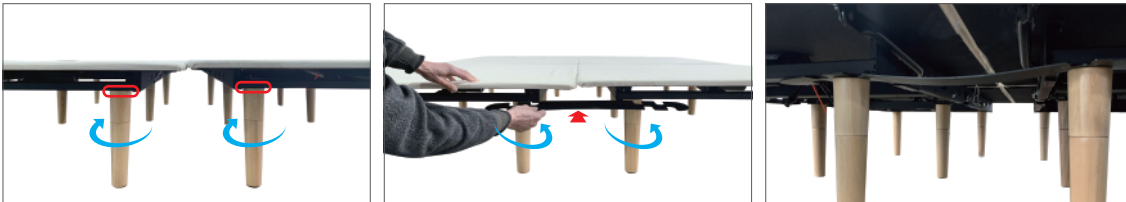

Troubleshooting

In the event that the power foundation fails to operate, assess the symptoms and possible solutions provided in the chart below.

SYMPTOMS	SOLUTIONS
Remote control illuminates and appears to be operable, but will not activate bed.	Verify that the power cord is plugged into a working, grounded electrical outlet. Test the outlet by plugging in another working appliance.
No features of the power foundation will activate.	<p>Program the remote control (see the Setting Programmable Positions and Pairing Remote section of this manual for programming procedures).</p> <p>Unplug the power cord, wait 30 seconds and plug back to reset electronic components.</p> <p>The surge protection device or the electrical outlet may be defective. Test the outlet by plugging in another working appliance.</p> <p>Verify that the connector on the wired remote control is securely attached to the control box.</p>
Wireless remote will not illuminate.	Replace the batteries in the wireless remote.
Head or foot section will elevate, but will not return to the horizontal (flat) position.	<p>Bed mechanism may be obstructed. Elevate bed and check for obstruction. Remove obstruction.</p> <p>Head section may be too close to the wall.</p> <p>Headboard may be too close to the edge of the mattress. Verify that there is enough distance between the headboard brackets and mattress. Adjust if required.</p>

In the event that the power foundation fails to operate, assess the symptoms and possible solutions provided in the chart below.

SYMPTOMS	SOLUTIONS
Head & Foot lift function has minor interference during operation.	<p>Check batteries in wireless remote control, replace with two (2) new AAA batteries if necessary.</p> <p>Make sure that you are following the duty cycle of the motors (do not operate more than two minutes over a 18-minute period, or approximately 10% duty cycle).</p> <p>Press the lift buttons squarely and accurately.</p> <p>Wireless remote control may be experiencing common Radio Frequency Interference from other radio transmitting devices. Wait several seconds, and then try pressing appropriate button again, See FCC Compliance Statement on page 5 of this guide.</p>
Excessive massage motor noise.	<p>If the bed is located on hard surface flooring, place carpet pieces or rubber pieces (not included) under each leg.</p> <p>Using the wireless remote control, elevate the head, foot or neck section a short distance to realign the lift/lower mechanisms with the bed support platform.</p> <p>Verify that your Power Foundation is not positioned against a wall, nightstand, or other object that may cause the vibration or noise.</p> <p>If the Power Foundation is installed over a bed frame, verify that the massage motors are not causing the bed frame (or bed frame components) to vibrate.</p> <p>Verify that the headboard attachment hardware is properly tightened (if used).</p>

SYMPTOMS	SOLUTIONS
A clicking noise is heard under the bed when raising or lowering.	This is normal. The lift motor relays “click” when they are engaged. No action is required.
Massage motor overheats or stops.	If the vibration motor overheats, the thermal protection will turn the motor off. Wait 30 minutes, turn the massage back on. If it does not come on, turn it off and report the situation to customer service.