

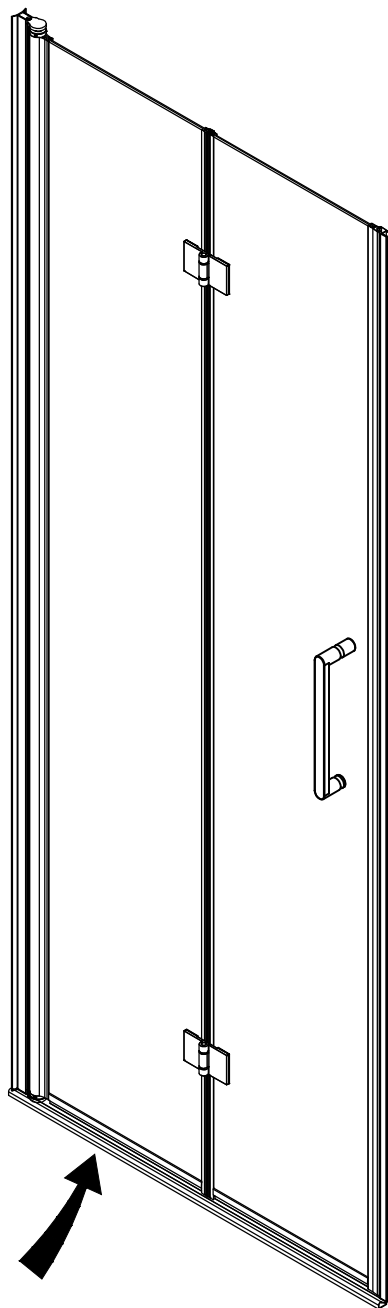

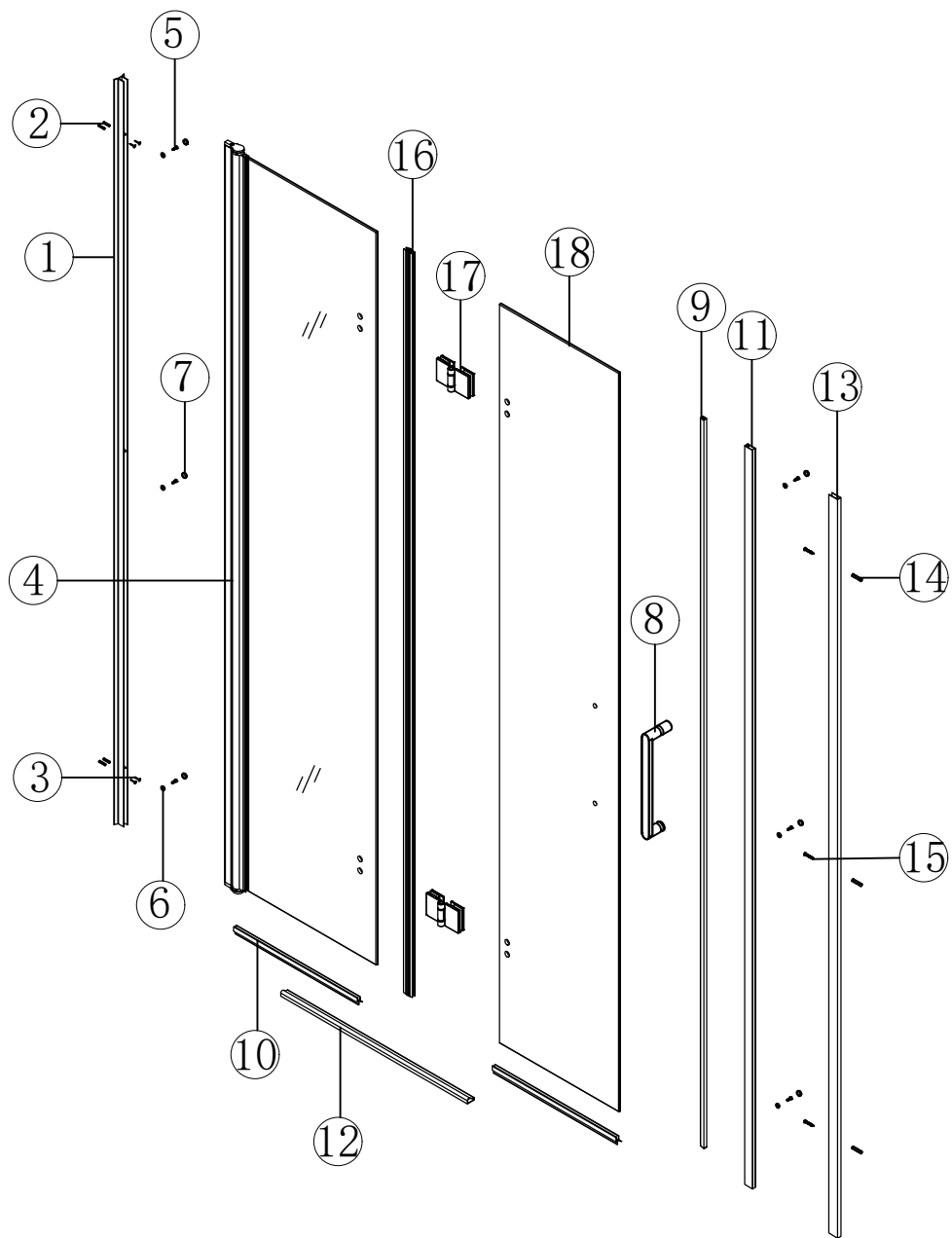











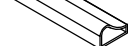

# INSTALLATION MANUAL



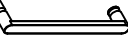

NO.	NAME	PICTURE	Qty	NO.	NAME	PICTURE	Qty
1	Pivot Wall Plate		1	10	Bottom Water Seal		2
2	8mm Wall Plug		4	11	Magnetic Strip		1
3	ST5*40		4	12	Water Guard Aluminum Profile		1
4	Pivot Assembly		1	13	Magnetic Wall Strip		1
5	ST4*10		6	14	6mm Wall Plug		3
6	Screw Cover Base		6	15	ST4*35		3
7	Screw Cover Cap		6	16	Integrated Gasket		1
8	Handle		1	17	Hinge		2
9	Magnetic Seal Strip		1	18	Live glass		1

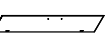
## TOOLS REQUIRED (NOT SUPPLIED)

-When you're ready to start, make sure that you have the following tools to hand, plenty of space and a clean dry area for assembly. Two people are needed. Please note: although these instructions are comprehensive, we always recommend that a technically competent installer should undertake installation.

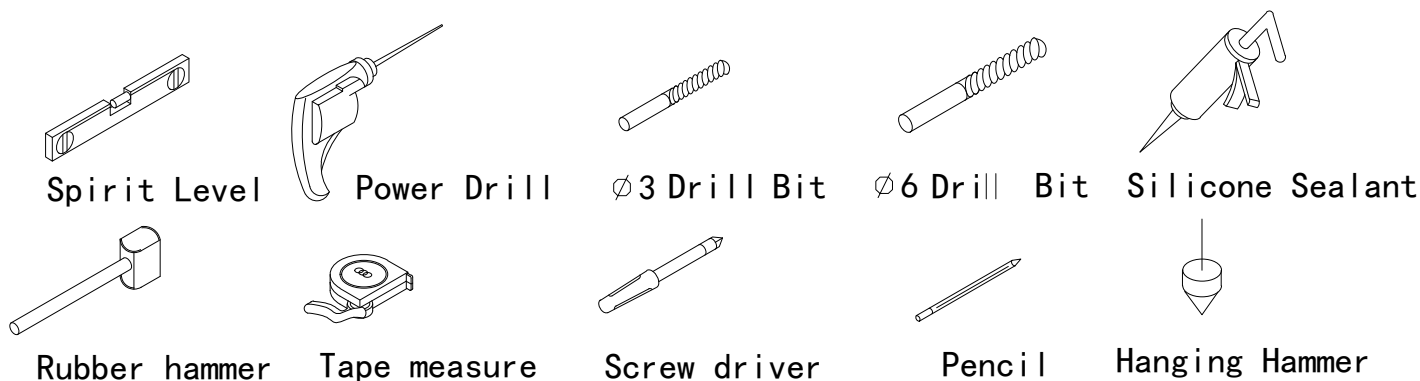

## PRE-INSTALLATION AND TECHNICAL REQUIREMENTS

- All dimensions are shown in millimeters, except where otherwise indicated.
- Ensure that the enclosure set is fitted to a level floor and vertical wall surface. Please note: The wall fixings included with this product are suitable for solid walls only. Plasterboard or stud walls may require specialist fixings (not supplied).

## IMPORTANT SAFETY NOTES

- Please handle all glass with care, avoiding knocks and shock loading to all sides and edges. Safety glass cannot be reworked.
- Care should be taken when drilling into walls to avoid hidden pipes or electrical cables.

## AFTERCARE INSTRUCTIONS

- Soap and water will be adequate to clean the glass - a glass cleaner can be used if required.
- In hard water districts, insoluble lime salts may be deposited on the glass. If this deposit is allowed to build up it becomes increasingly difficult to remove and looks unsightly. Regular cleaning will minimise this effect.

