

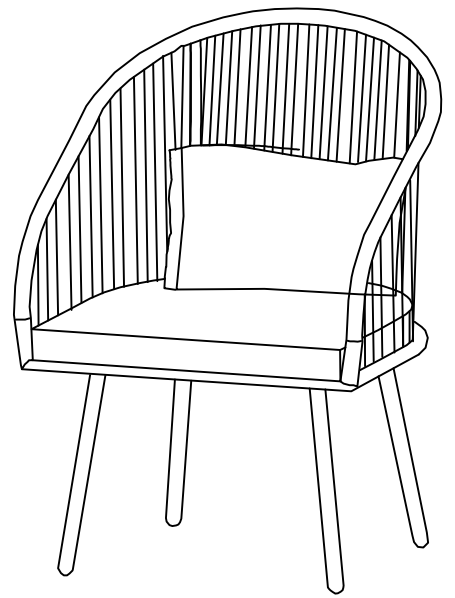

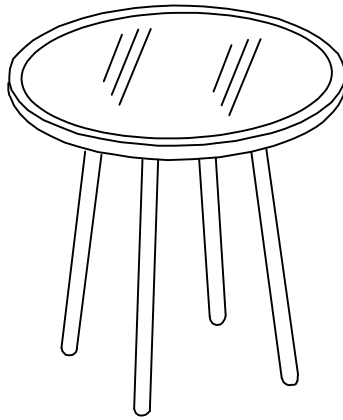

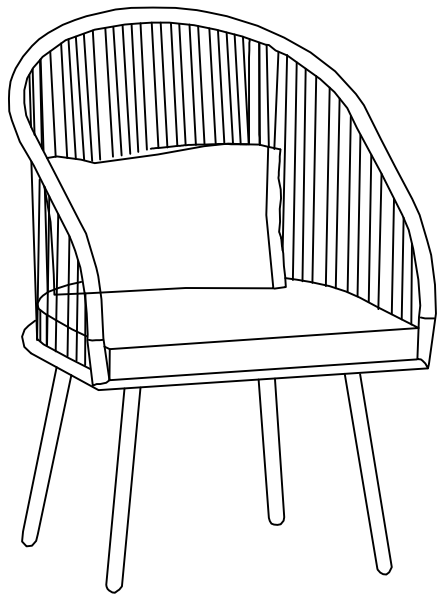

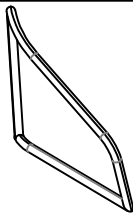

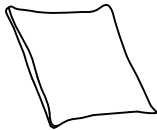
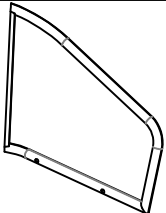
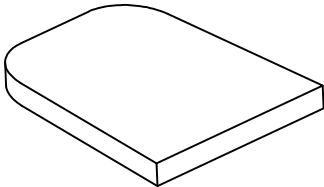
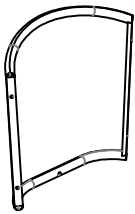
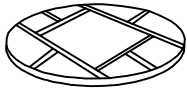
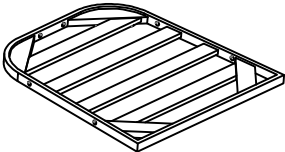

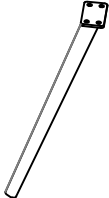
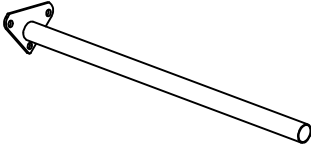
Assembly Instruction

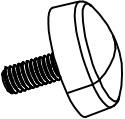
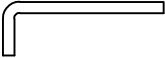

- ⚠ 1. Confirm all parts are present prior to assembly.
- 2. Assemble on a flat, clean and soft surface.
- 3. Do not fully tighten screws until all parts are assembled.

Item no.	Reference Image	Qty.	Item no.	Reference Image	Qty.
A		X2	G		X2
B		X2	H		X2
C		X2	I		X1
D		X2	J		X1
E		X4	K		X4
F		X4	L		X1

Item no.	Reference Image	Qty.
M		X8
N	 M6X35mm	X12
O	 M6X15mm	X44
P		X72
Q		X12
R		X1
N1	 M6X40mm	X8

1

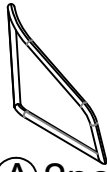

Ⓐ 2pcs

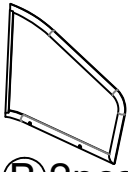

Ⓑ 2pcs



Ⓒ 2pcs



⒫ 16pcs



Ⓐ1 8pcs



Ⓜ 8pcs

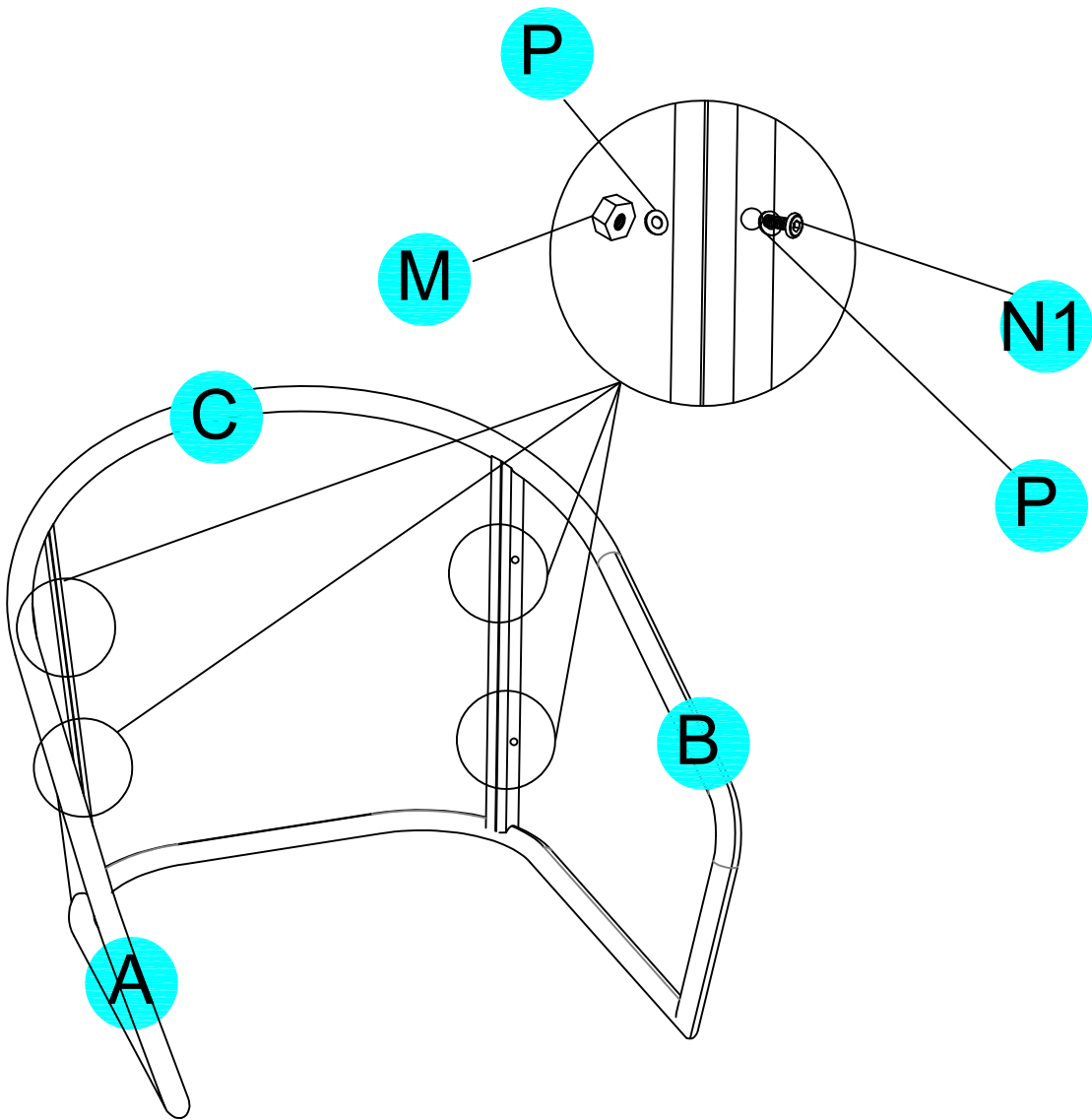

Do not fully tighten screws until all parts are assembled.

1

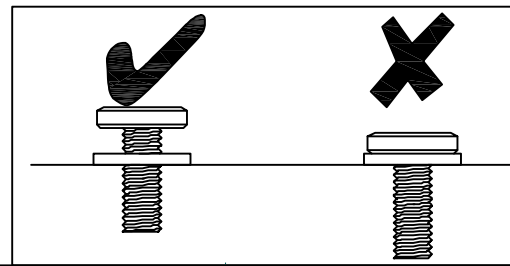

2

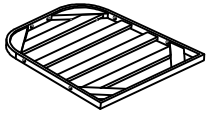

D 2pcs



P 12pcs



N 12pcs

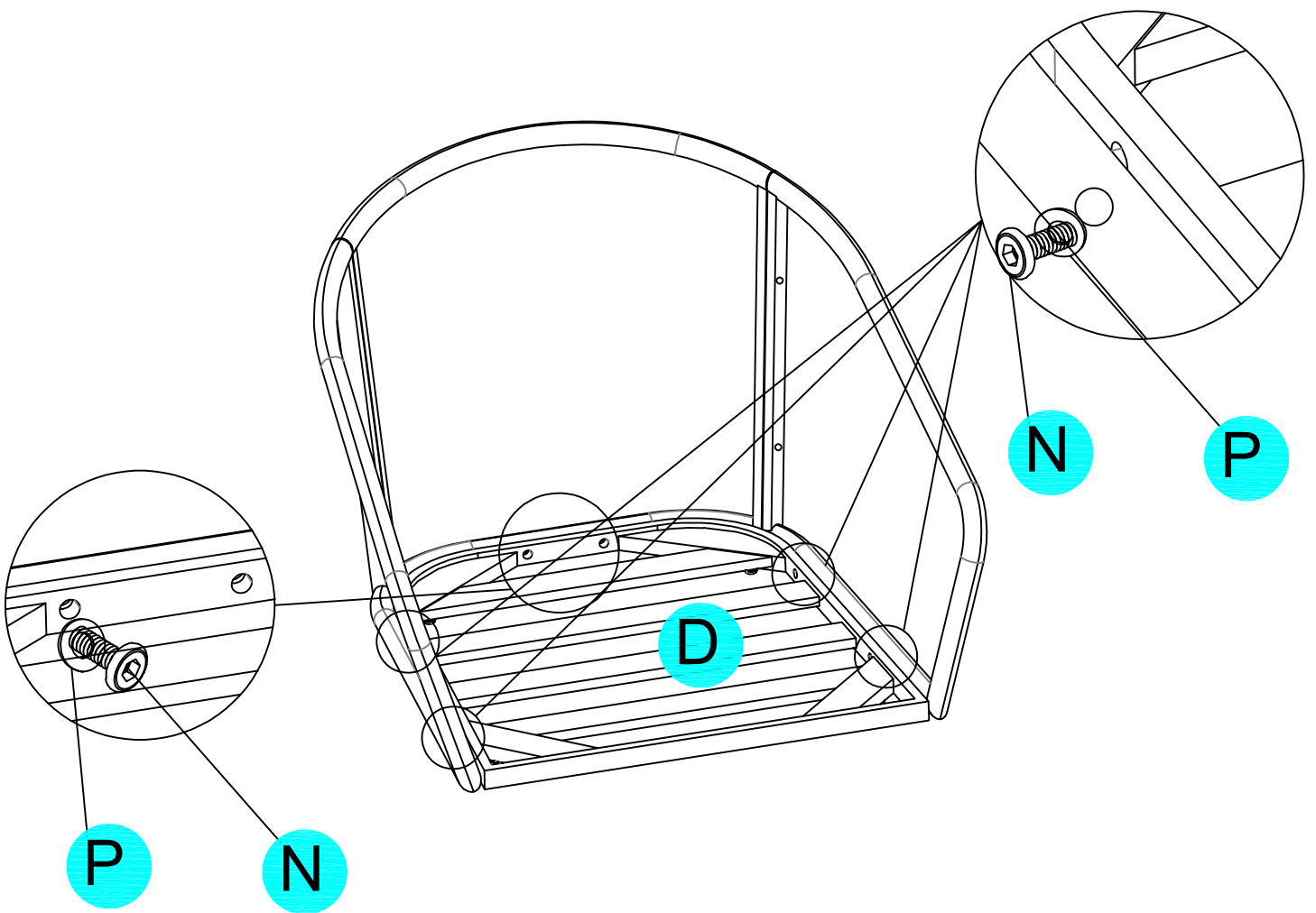

Do not fully tighten screws until all parts are assembled.

2

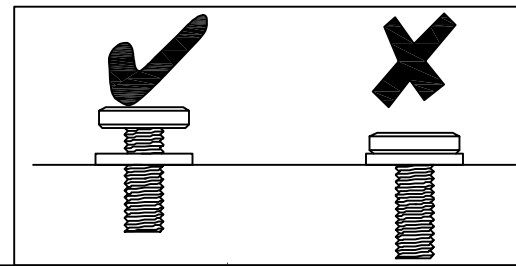

3

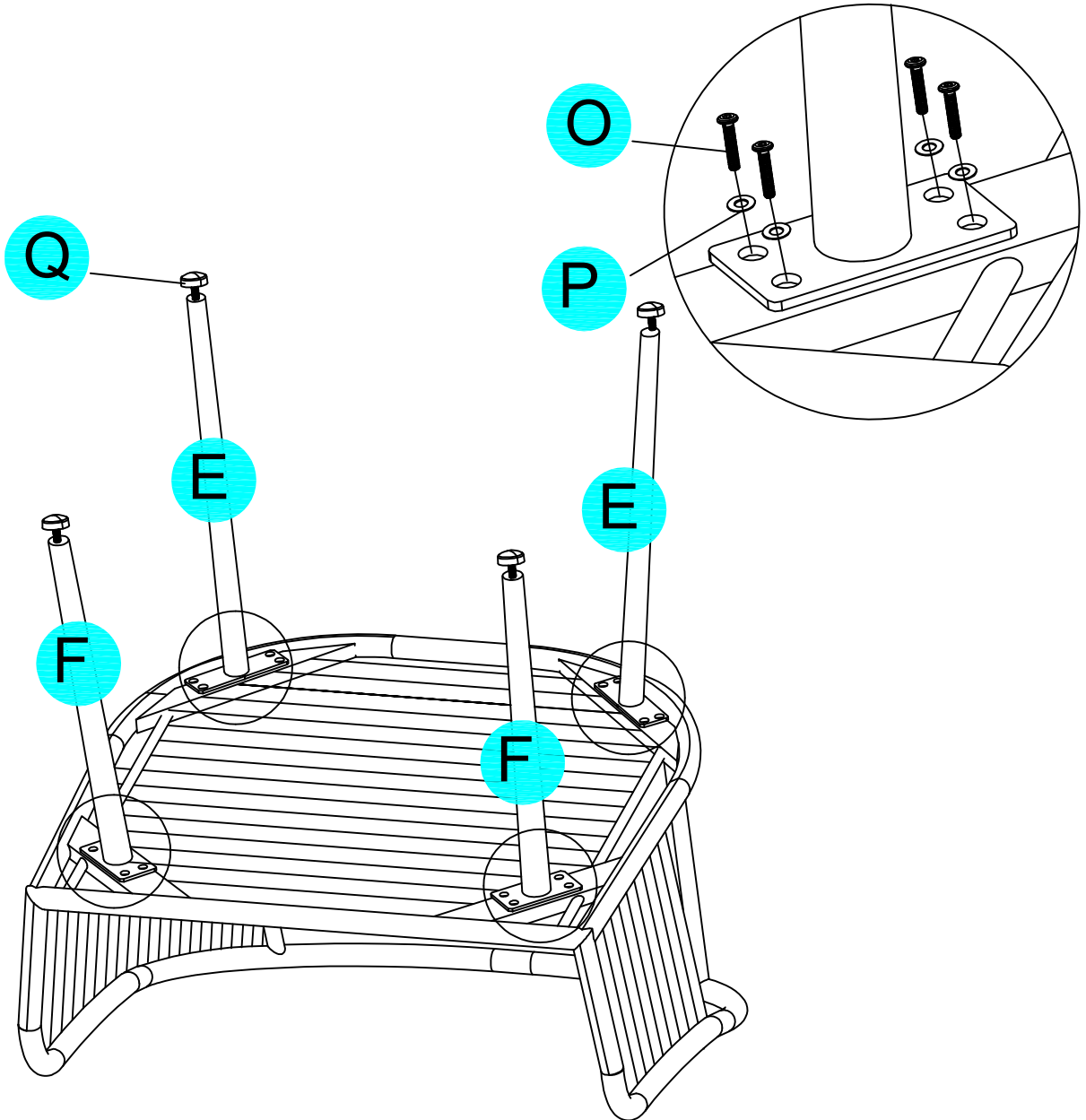
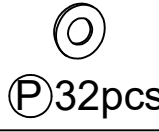
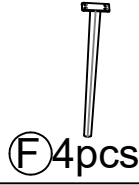

Do not fully tighten screws until all parts are assembled.

3

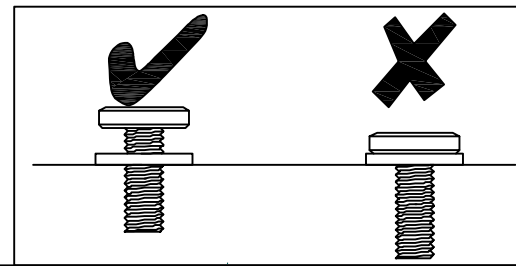

4

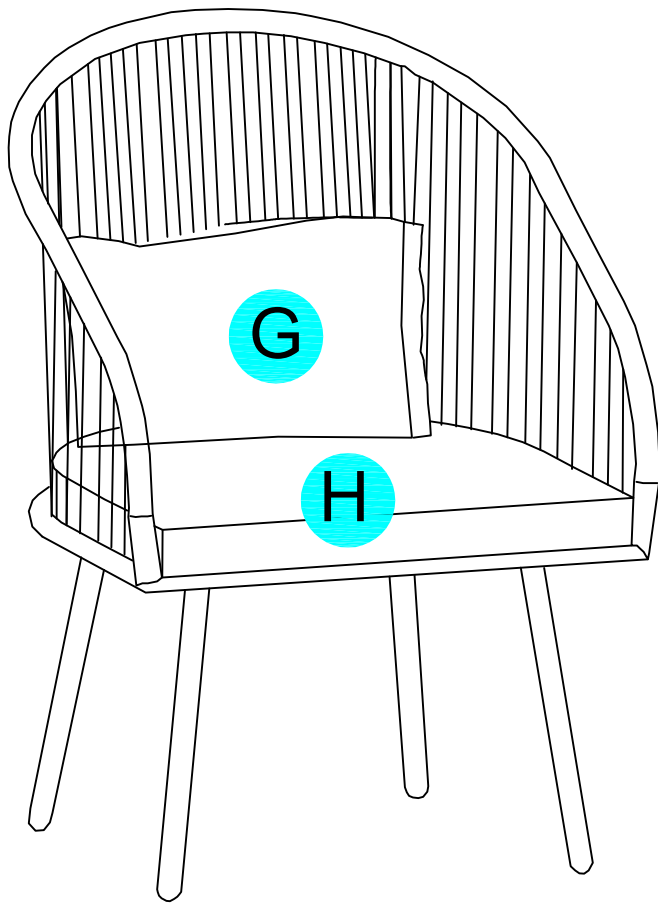
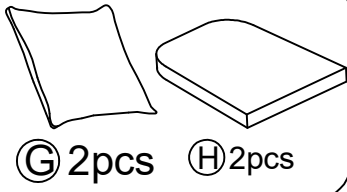



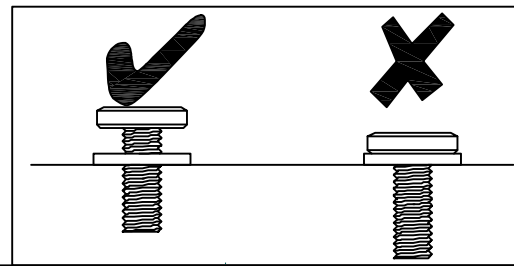

Do not fully tighten screws until all parts are assembled.

4

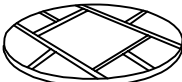

5

-  P 12pcs
-  O 12pcs
-  Q 4pcs
-  K 4pcs
-  I 1pcs

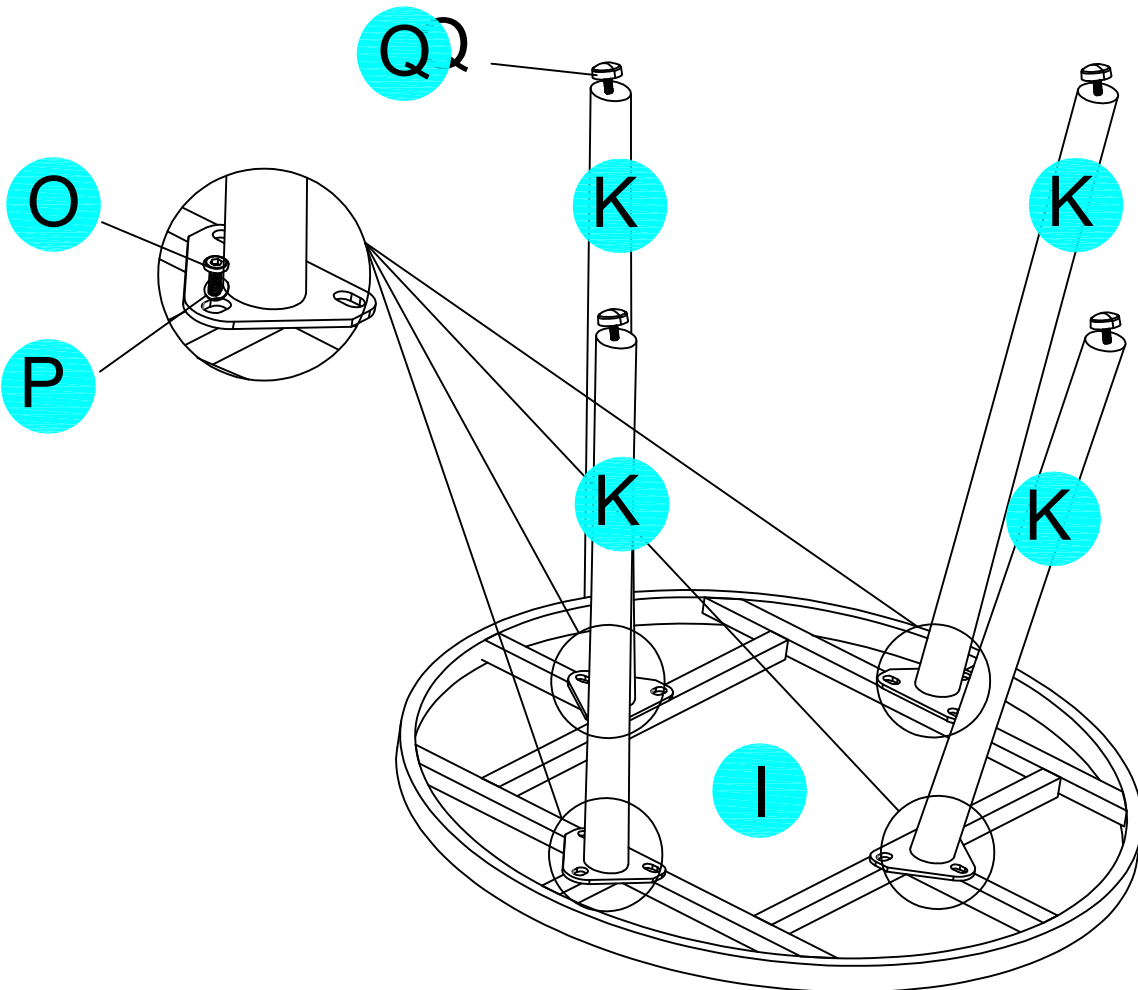

Do not fully tighten screws until all parts are assembled.

5

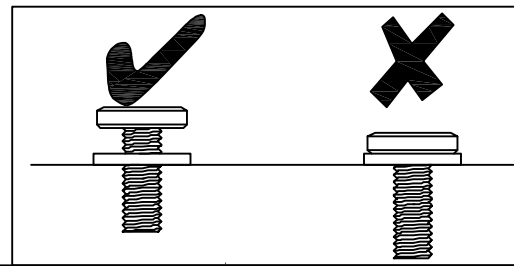

6



ⓐ 1 pcs

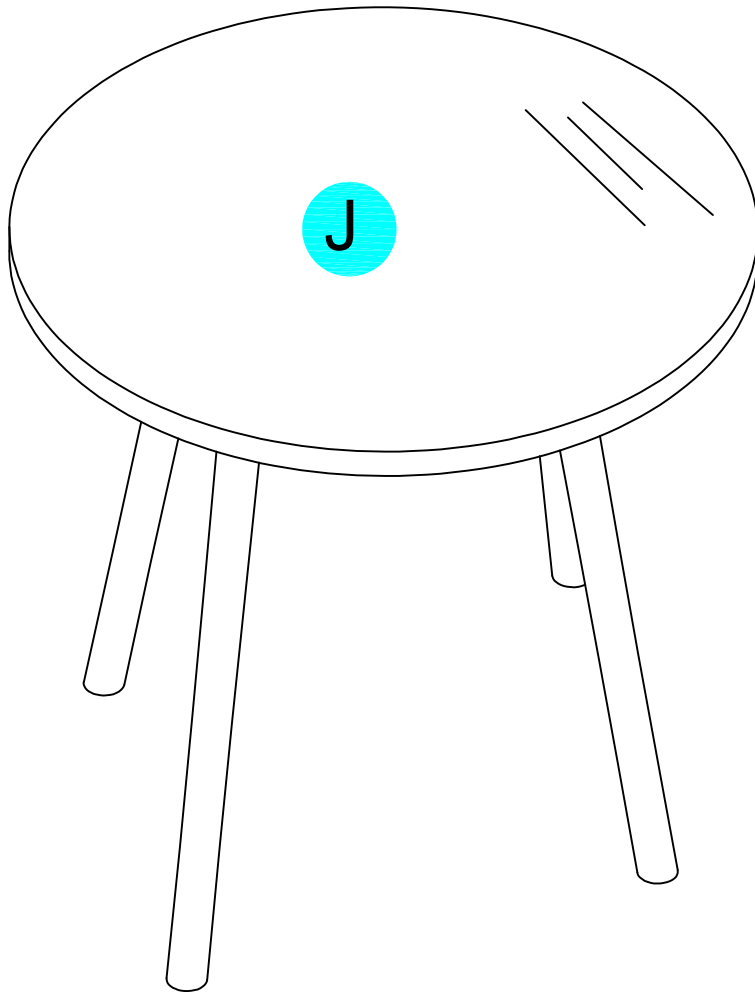

Do not fully tighten screws until all parts are assembled.

6

