

Anleitung

Assenbly Instrustion

Le manuel d'emploi



WF325600

TIPPS

1. Dieses Produkt wird für die Lieferung in 2 Pakete aufgeteilt. Sie kommen möglicherweise nicht gleichzeitig an. Bitte warte geduldig .
2. Wir danken Ihnen für den Einkauf! Wir bemühen uns, Ihnen qualitativ hochwertige Produkte zu bieten. In seltenen Fällen, dass Ihr Produkt beschädigt ist, Teile fehlt oder Sie auf Probleme bei der Montage stoßen, wenden Sie sich damit bitte an unseren Kundendienst, wir werden Ihnen die beste Lösung so schnell wie möglich bieten. Um Ihr Problem schnell zu lösen, bitte stellen Sie uns einige Bilder zur Verfügung, die das Produktproblem deutlich widerspiegeln können. Vielen Dank !
3. Setzen Sie die Schrauben in die Löcher ein und ziehen Sie die Schrauben an, aber nicht zu fest, 70 % ~ 80 % ist genug, und ziehen Sie schließlich alle Schrauben an. Wenn einige Schrauben nicht mit den Löchern ausgerichtet sind oder die Montage einiger Teile schwierig ist, stellen Sie bitte den Straffheitsgrad der Schrauben um.
4. Es wird empfohlen, dass 2 Personen das Produkt installieren.

Tips

1. Please read the instructions fully before assembly. These instructions include important information which could ensure correct assembly. We have been working on providing high quality products for you. However, in the rare instance that your product is defective, missing parts or there are some issues, please don't hesitate to contact our customer service to submit parts requirements, assembly suggestion, or warranty claims, and we will give the best solution as soon as possible. If necessary, we need you to provide some more clear pictures of the issue.
- 2.Thank you for shopping! We strive to provide you with high quality products. In rare cases that your product is damaged, missing parts or you encounter assembly problems, please contact our customer service with it, we will offer you the best solution as soon as possible. In order to solve your problem quickly, please provide us with some pictures that can clearly reflect the product problem. Thanks very much !
3. Insert the screws in holes and tighten the screws, but not too tight, 70%~80% is ok, finally tighten all the screws. If some issues happened that some screws can not target to the hole or some parts are difficult to install, please adjust the tightness of the screws.
4. 2 people are recommended to finish.

Conseils

- 1.Veuillez lire attentivement les instructions avant le montage. Ces instructions contiennent des informations importantes qui pourraient garantir un montage correct. Nous avons travaillé pour vous fournir des produits de haute qualité. Cependant, dans les rares cas où votre produit est défectueux, s'il manque des pièces ou s'il y a des problèmes, n'hésitez pas à contacter notre service client pour soumettre des exigences de pièces, des suggestions d'assemblage ou des réclamations de garantie, et nous vous donnerons la meilleure solution comme dès que possible. Si nécessaire, nous avons besoin que vous fournissiez des images plus claires du problème.
- 2.Merci pour vos achats ! Nous nous efforçons de vous fournir des produits de haute qualité. Dans les rares cas où votre produit est endommagé, des pièces manquantes ou que vous rencontrez des problèmes de montage, veuillez contacter notre service client avec celui-ci, nous vous proposerons la meilleure solution le plus vite possible. Afin de résoudre votre problème rapidement, veuillez nous fournir des images qui peuvent clairement refléter le problème du produit. Merci beaucoup !
- 3.Insérez les vis dans les trous et serrez les vis, mais pas trop serré, 70% ~ 80% est ok, enfin serrez toutes les vis. Si certains problèmes surviennent, certaines vis ne peuvent pas viser le trou ou certaines pièces sont difficiles à installer, veuillez ajuster le serrage des vis.
4. Deux personnes sont recommandées pour le terminer.

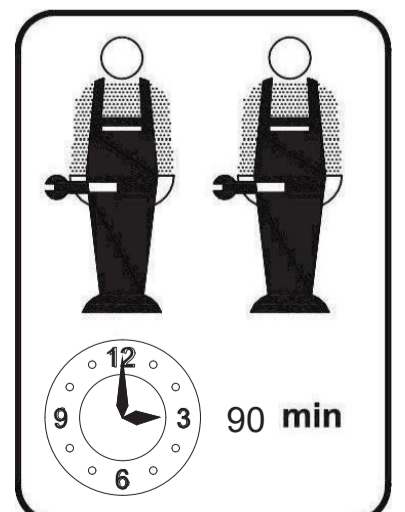

**FR - Notice de montage / EN - Assembly instructions / PT - Instruções de montagem /
ES - Prospecto de montaje / DE - Montageanleitung / IT - Istruzioni di montaggio /
NL - Montagehandleiding**

FR - IMPORTANT! CONSERVER POUR CONSULTATION ULTERIEURE: LIRE ATTENTIVEMENT

- A monter par un adulte. Un adulte doit vérifier le bon assemblage avant l'emploi
- ATTENTION! tenir les vis et petits éléments et sachets hors de portée des enfants
- Bien identifier les éléments avant de commencer le montage
- Ne pas utiliser votre article lorsque l'un de ses éléments est cassé ou manquant
- En cas de problème contactez notre service après-vente
- Toujours suivre les instructions du fabricant
- Entretien: nettoyer avec un chiffon doux et sec. En cas de taches plus grosses, frottez soigneusement avec une éponge légèrement humide et non abrasive
- Ne pas sauter sur le lit

EN - IMPORTANT! KEEP FOR FUTURE REFERENCE: READ CAREFULLY

- To be assembled by an adult. Assembly must be checked by an adult before use
- WARNING! keep all screws, small parts and plastic bags out of the reach of children
- Properly identify all parts before assembling
- Never use your item if any of its parts are broken or missing
- Should any problems arise, please contact our After Sales Service
- Manufacturer's instructions shall be followed at all times
- Care: clean with a soft, dry cloth. In case of larger stains, carefully rub with a slightly damp, non-abrasive sponge
- Do not jump on the bed

PT - IMPORTANTE! GARDE PARA CONSULTA POSTERIOR: LER ESTAS INSTRUÇÕES CUIDADOSAMENTE

- A ser montado por um adulto. Um adulto deve verificar a boa montagem antes da utilização
- Atenção! mantenha os parafusos, acessórios pequenos e saco de plástico fora do alcance das crianças
- Identifique bem os acessórios antes de começar a montagem
- Não utilizar o artigo se um dos elementos está em falta ou danificado
- Para qualquer esclarecimento, contacte os nossos serviços através do telefone
- As instruções do fabricante devem ser sempre cumpridas
- Manutenção: limpe com um pano macio e seco. Em caso de manchas maiores, esfregue cuidadosamente com uma esponja ligeiramente húmida e não abrasiva
- Não salte na cama

ES - IMPORTANTE! CONSERVAR PARA FUTURAS CONSULTAS: LEER DETENIDAMENTE

- A montar por un adulto. Un adulto debe comprobar el buen montaje antes de la utilización
- ¡ADVERTENCIA! mantener los tornillos, los pequeños elementos y bolsitas fuera del alcance de los niños
- Identificar debidamente los elementos antes de empezar el montaje
- No utilizar este artículo si uno de los elementos falta o esta roto
- Si tiene problemas, contactar nuestro servicio postventa
- Deben seguirse siempre las instrucciones del fabricante Cuidados: limpiar con un paño suave y seco. En caso de manchas grandes, frotar con cuidado utilizando una esponja húmeda no abrasiva
- No saltar sobre la cama

DE - WICHTIG! FÜR SPÄTERE BEZUGNAHME AUFBEWAHREN: SORGFÄLTIG LESEN

- Von einem Erwachsenen zu montieren. Die korrekte Montage muss vor Gebrauch von einem Erwachsenen geprüft werden
- Achtung! die Schrauben und kleinen Teile ausserhalb der Reichweite von Kindern lagern
- Vor Montagebeginn alle Teile identifizieren
- Ihren Artikel nicht benutzen, wenn eines seiner Bestandteile beschädigt ist oder fehlt
- Im Problemfall Ihren Kundendienst anrufen
- Stets die Herstelleranweisungen beachten
- Wartung: Mit einem weichen, trockenen Tuch reinigen. Bei größeren Flecken vorsichtig mit einem leicht feuchten, nicht scheuernden Schwamm abreiben
- Nicht auf dem Bett springen

IT - IMPORTANTE! CONSERVARE QUESTE INFORMAZIONI PER ULTERIORI CONSULTAZIONI: LEGGI ATTENTAMENTE

- Il montaggio deve essere eseguito da un adulto. Un adulto dovrà verificare il corretto montaggio prima dell'uso
- ATTENZIONE! tenere le viti ed i componenti di piccole dimensioni lontano dalla portata dei bambini
- Controllare i pezzi prima del montaggio
- L'articolo non deve essere utilizzato in caso di elementi mancanti o danneggiati
- In caso di necessità contattare il nostro servizio post-vendita
- Seguire sempre le istruzioni del costruttore
- Manutenzione: pulire con un panno morbido e asciutto. Per le macchine più grandi, strofinare accuratamente con una spugna leggermente umida e non abrasiva
- Non saltare sul letto



NL - BELANGRIJK! BEWAAR VOOR LATERE RAADPLEGING: LEES AANDACHTIG

- Moet door een volwassene worden gemonteerd. Voor gebruik moet een volwassene controleren dat het product goed in elkaar is gezet
- WAARSCHUWING! schroeven en kleine elementen en zakjes buiten bereik van kinderen houden
- De elementen goed identificeren alvorens met de montage te beginnen
- Uw artikel niet gebruiken wanneer een van de onderdelen kapot is of ontbreekt
- Neem bij problemen contact op met onze klantenservice
- Volg altijd de instructies van de fabrikant
- Onderhoud: maak schoon met een zachte en droge doek. In geval van grotere vlekken, veeg voorzichtig schoon met een licht bevochtigde en niet-schurende spons
- Niet springen op het bed

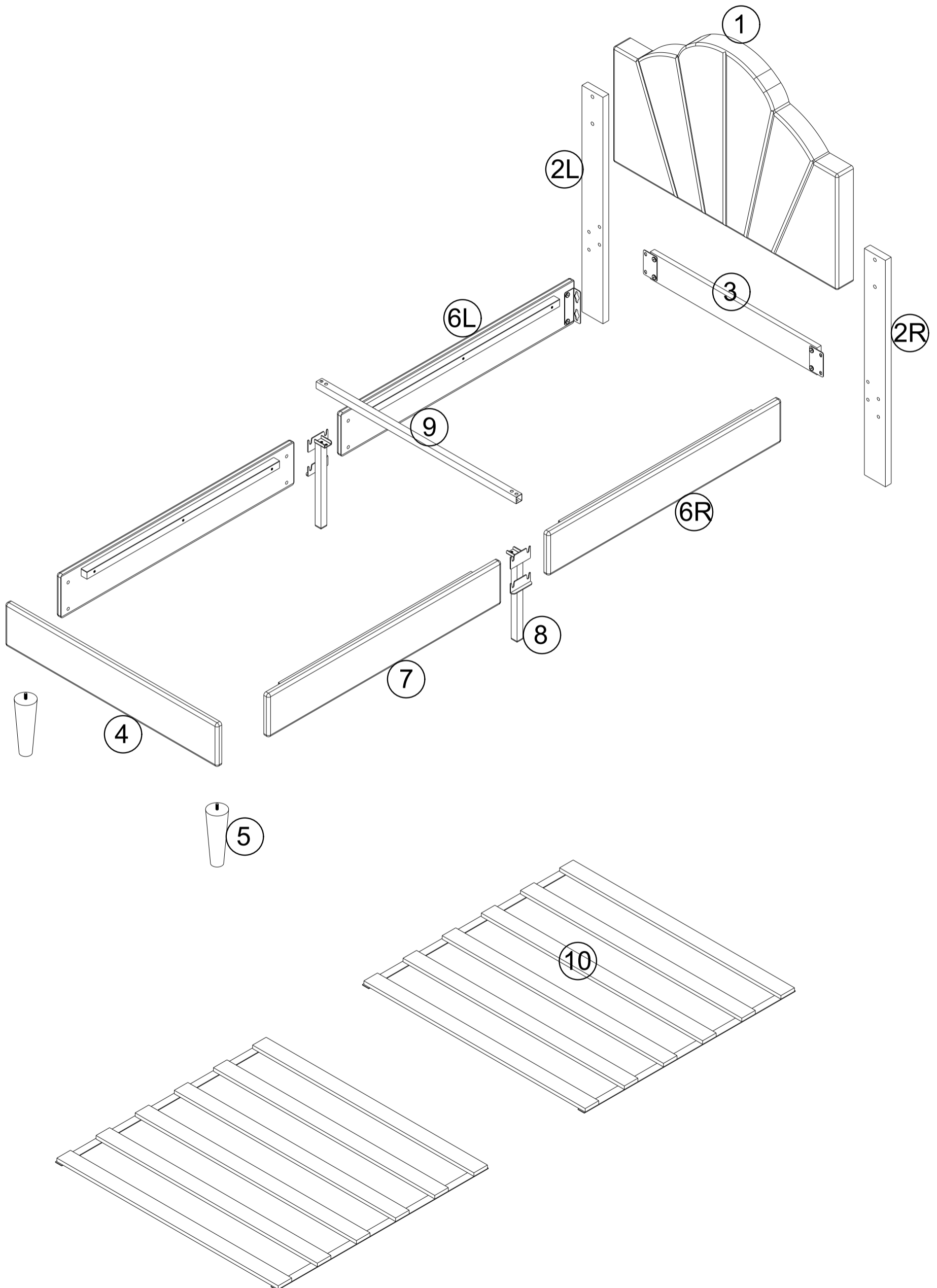
Stückliste



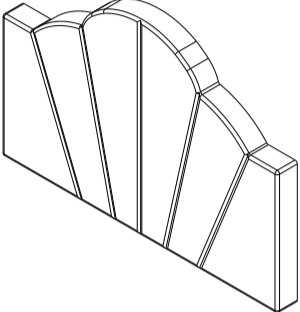

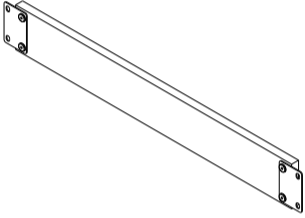
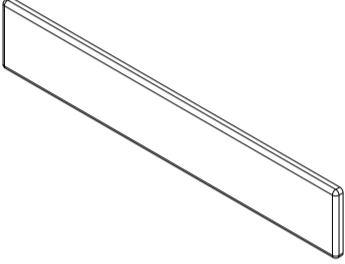
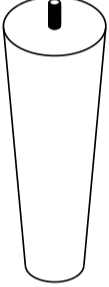
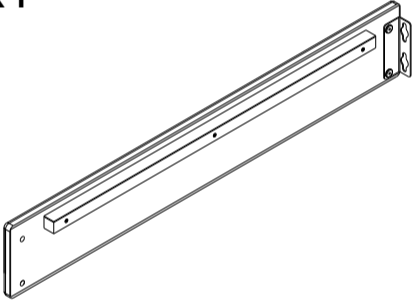
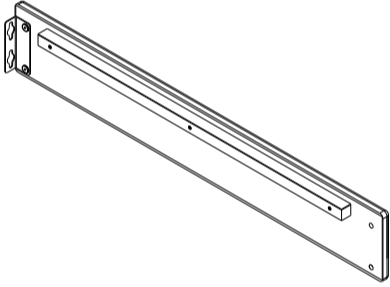
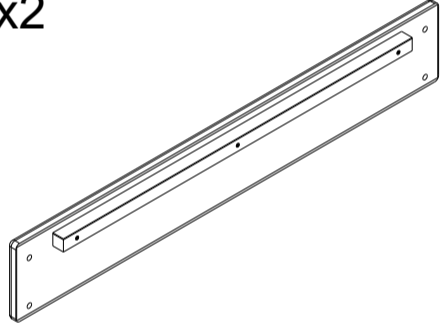
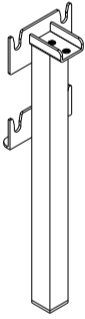
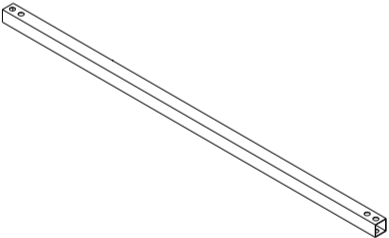
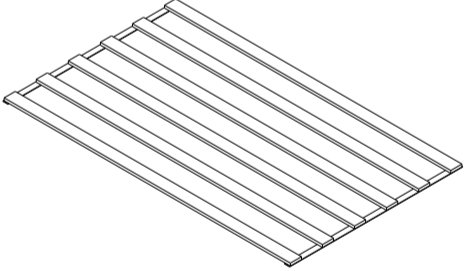
Teileliste-Parts list-Liste des pieces WF325600

<p>① x1</p> 	<p>②L x1</p> 	<p>②R x1</p> 
<p>③ x1</p> 	<p>④ x1</p> 	<p>⑤ x2</p> 
<p>⑥L x1</p> 	<p>⑥R x1</p> 	<p>⑦ x2</p> 
<p>⑧ x2</p> 	<p>⑨ x1</p> 	<p>⑩ x2</p> 

Hardware List-Liste de matériel

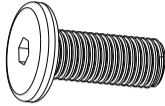
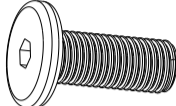
WF325600

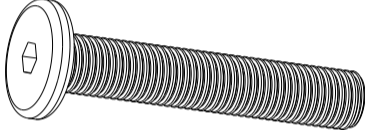
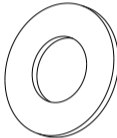
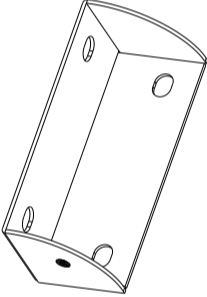

<p>A x1</p> 	<p>B x16</p>  <p>M8x16mm</p>	<p>D x8</p>  <p>M8x25mm</p>
<p>E x4</p>  <p>M8x35mm</p>	<p>F x4</p>  <p>M8x50mm</p>	<p>G x8</p> 
<p>H x2</p> 		

1

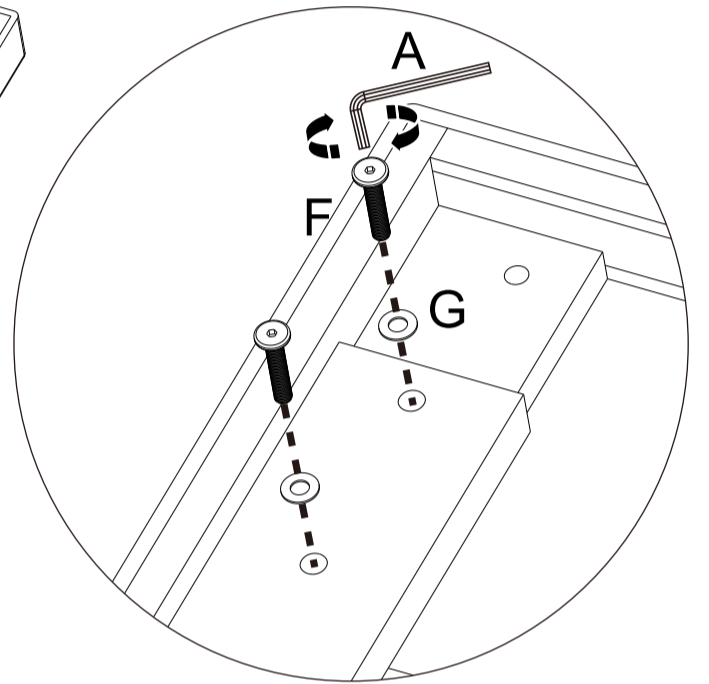
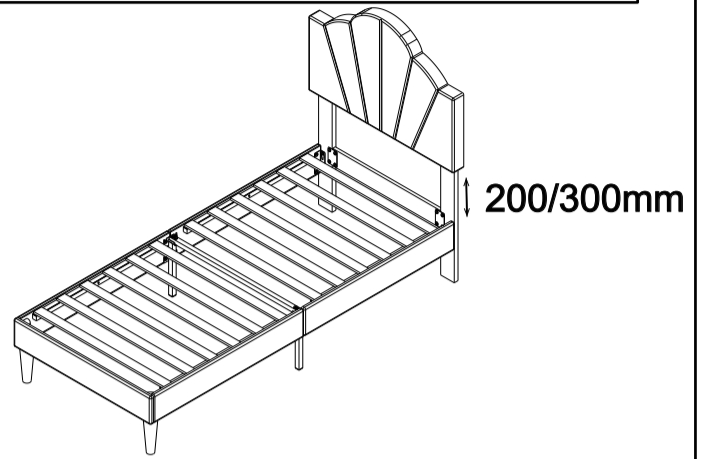
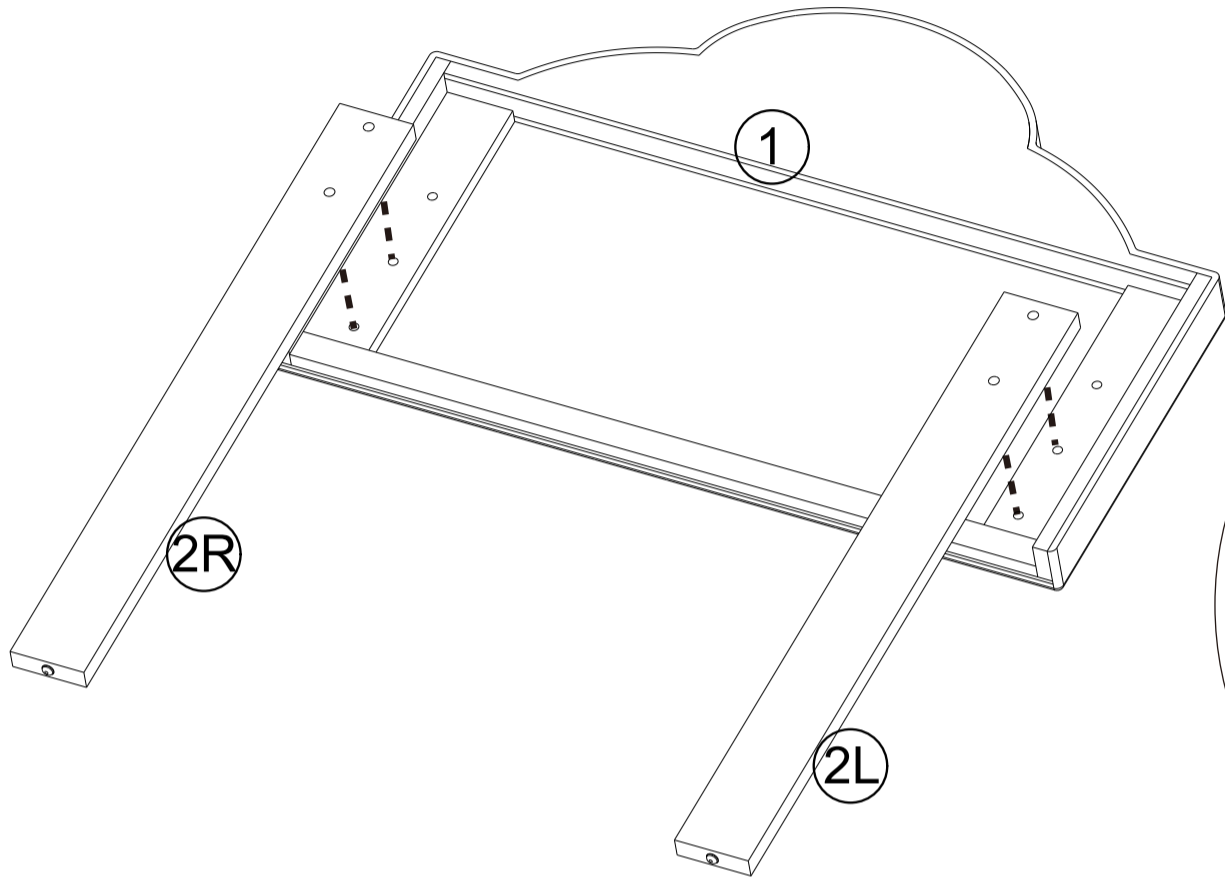
A x 1 	F x 4 M8 x 50mm 	G x 4 	
--	---	---	--



2

A x 1 	D x 4 M8 x 25mm 		
--	---	--	--

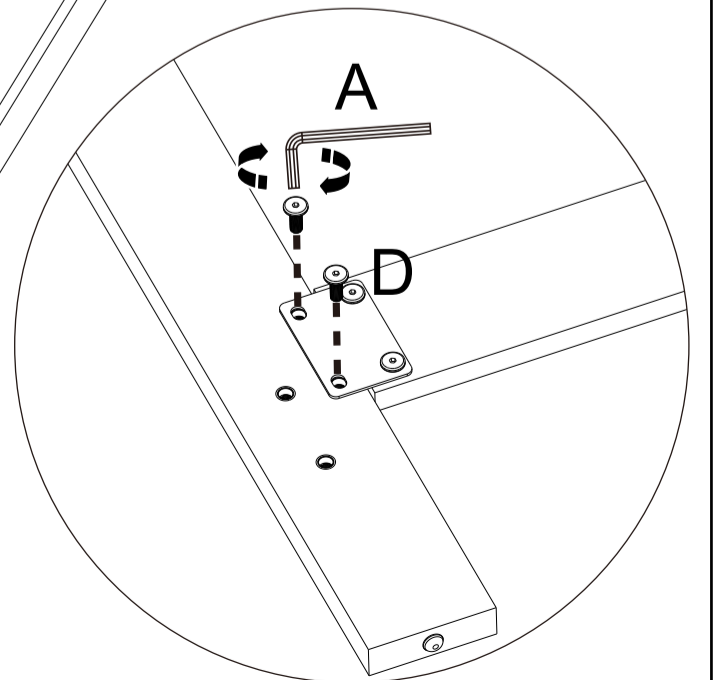
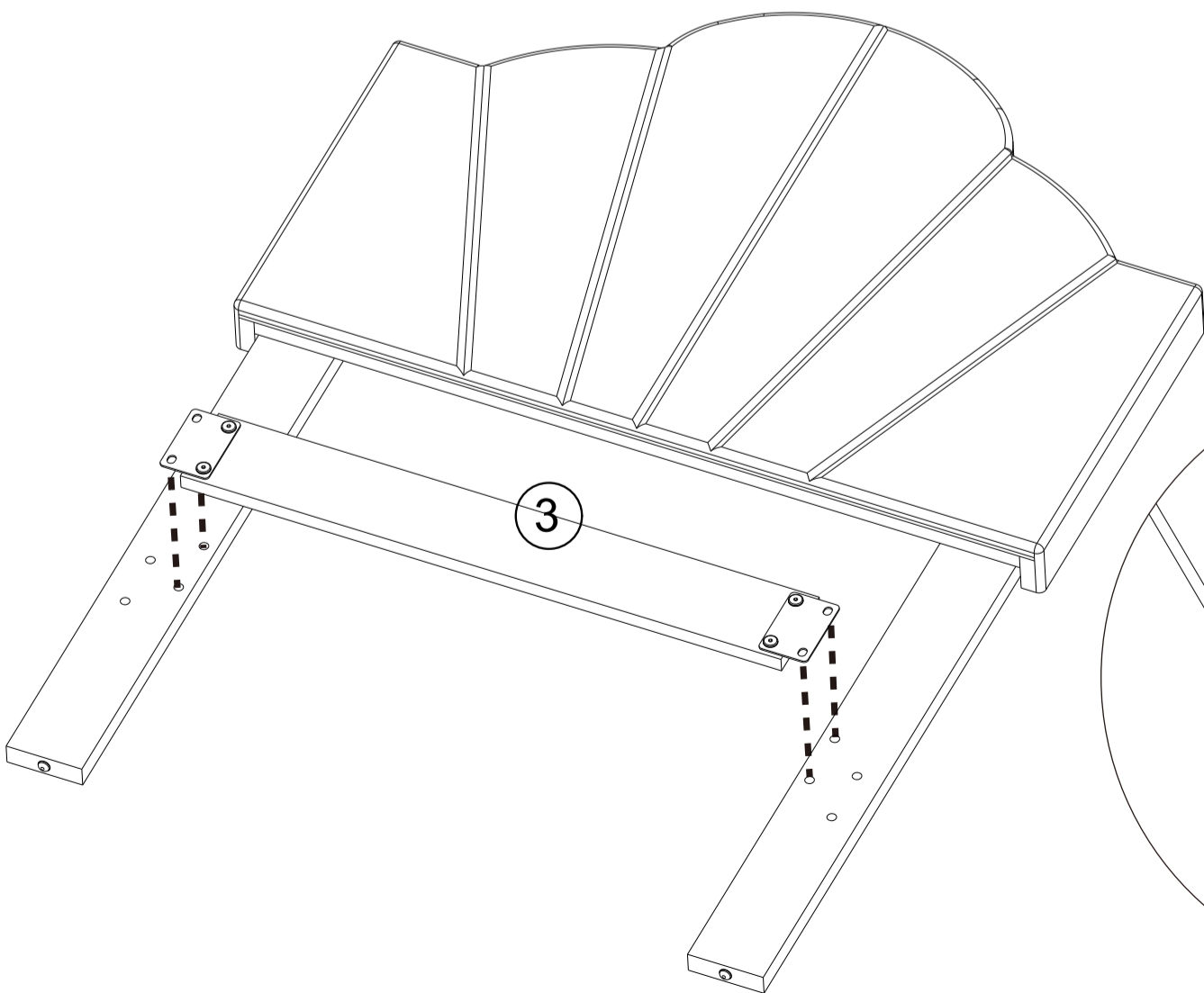

3

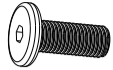
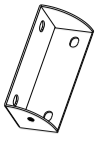
A x 1 	B x 4  M8 x 16mm	H x 2 	
--	---	---	--

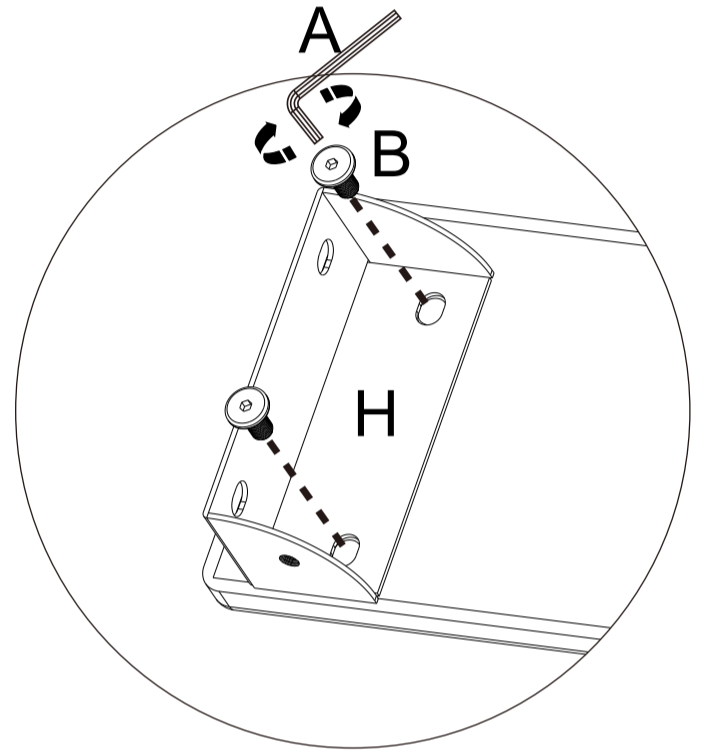
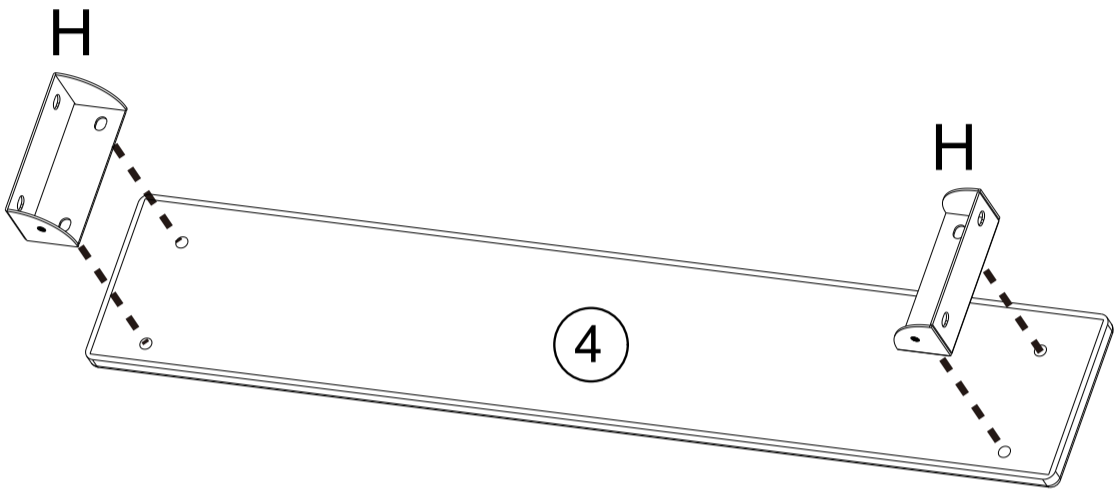

4

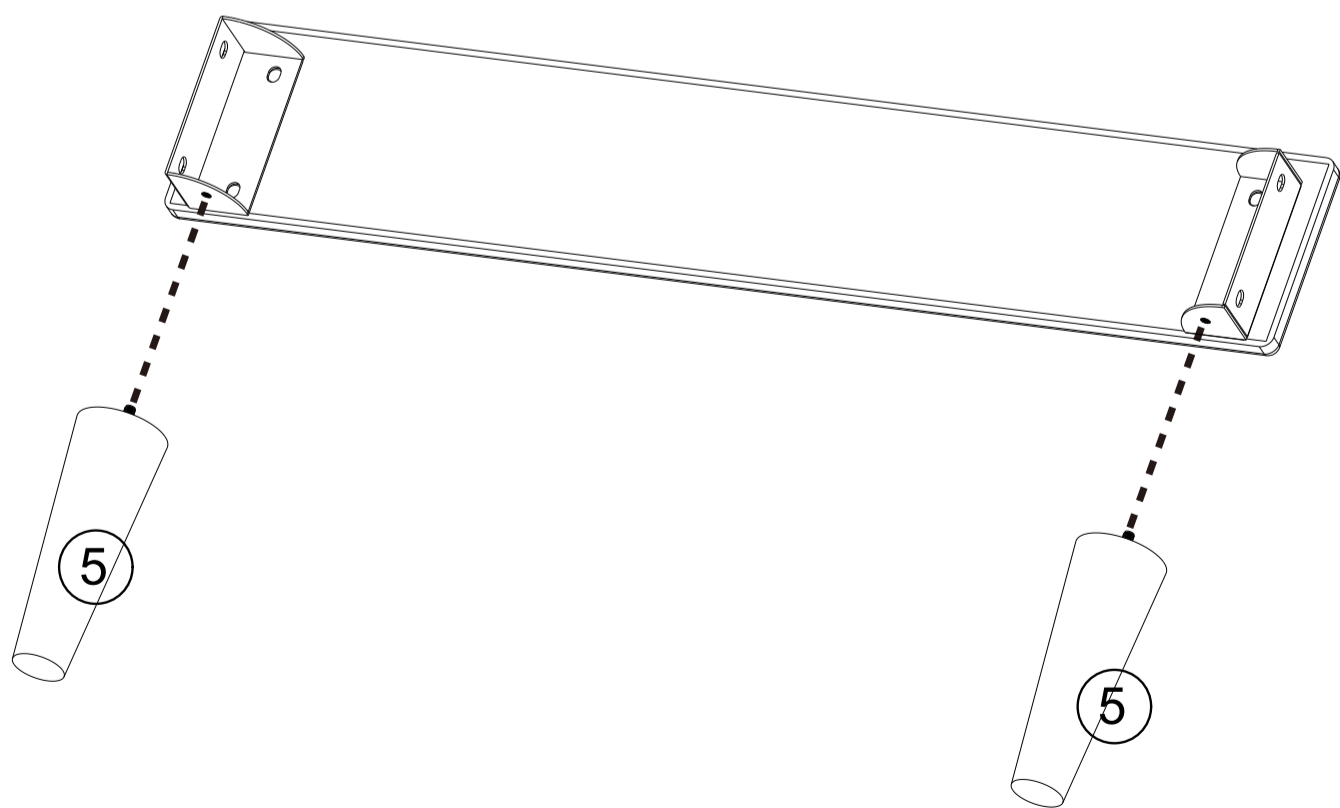

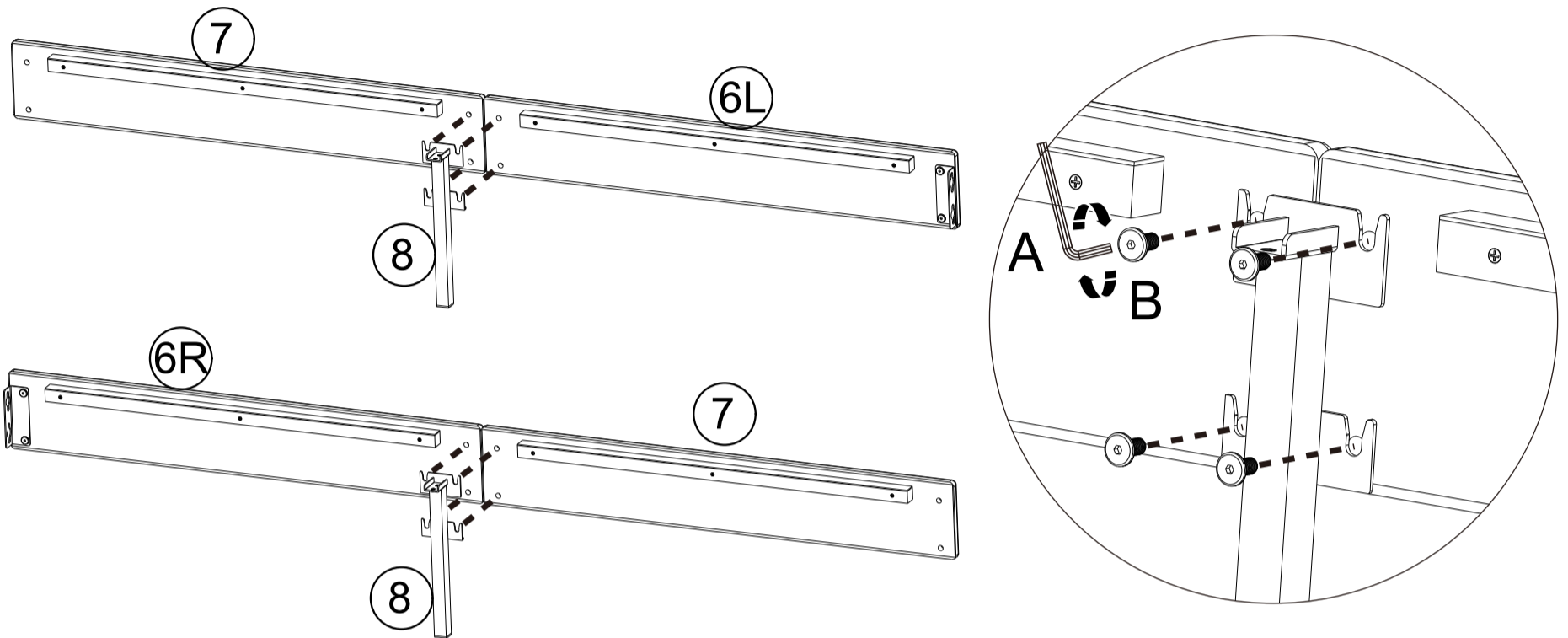

5

A x 1 	B x 8  M8 x 16mm	
--	---	--

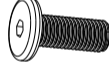

6

A x 1 	B x 4  M8 x 16mm	D x 4  M8 x 25mm	
--	---	--	--

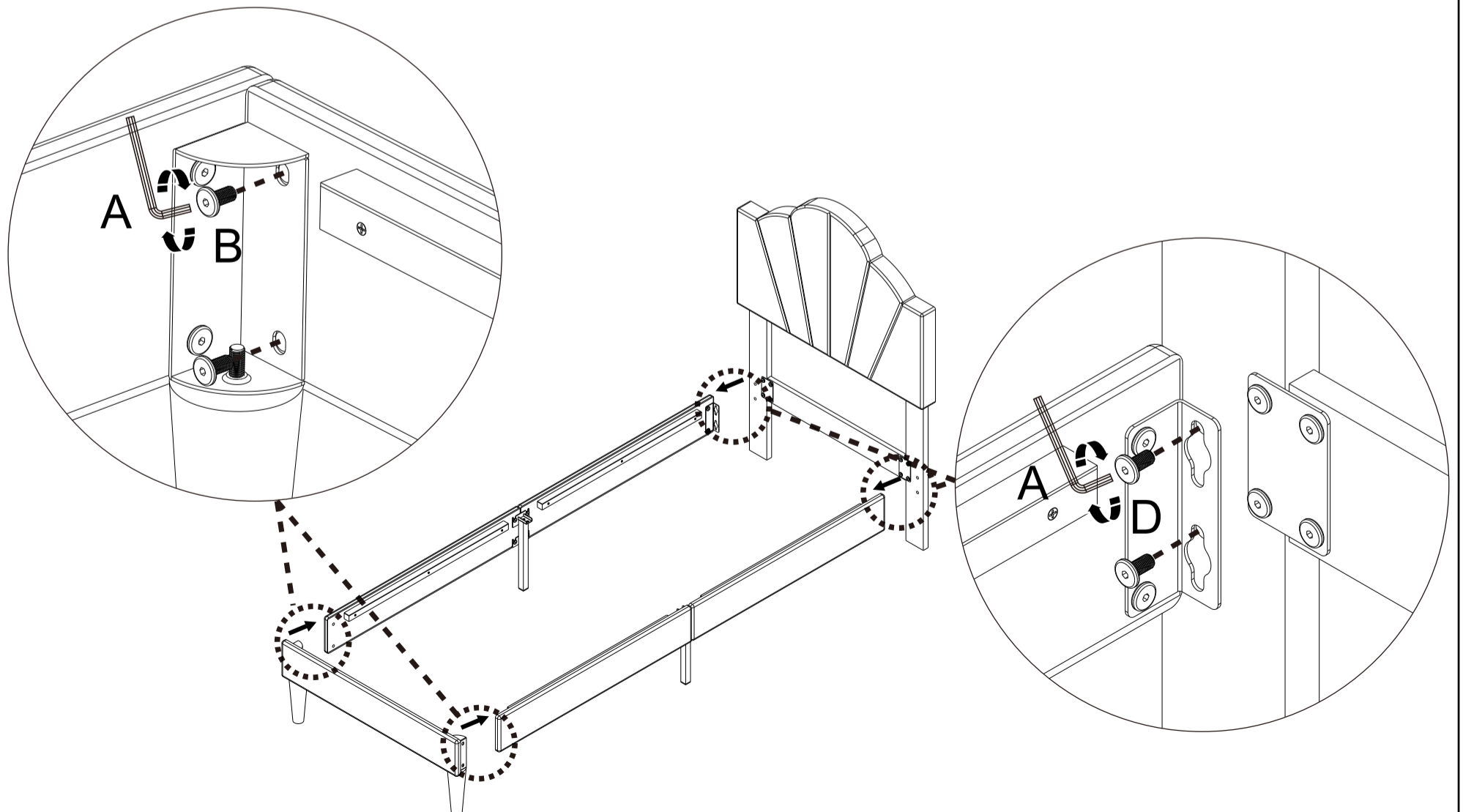

7

A x 1 	E x 4 M8 x 35mm 	G x 4 	
--	---	---	--

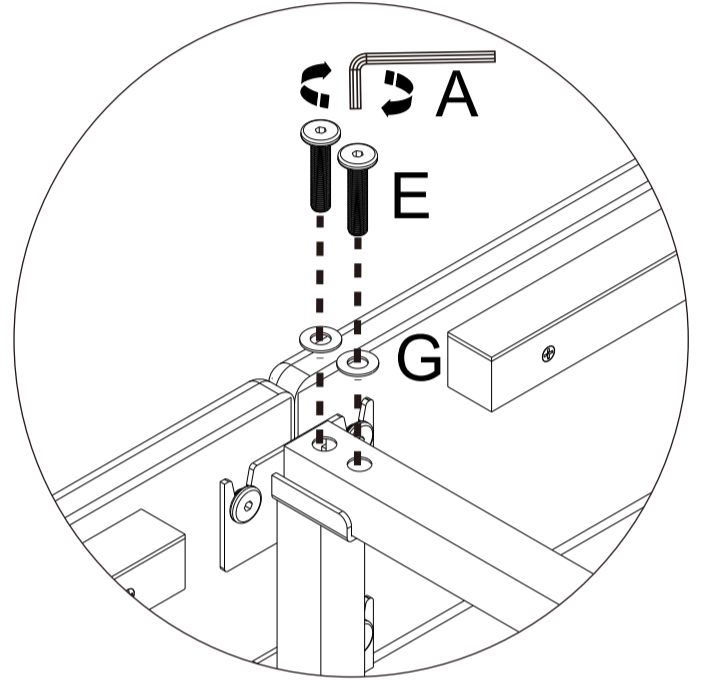
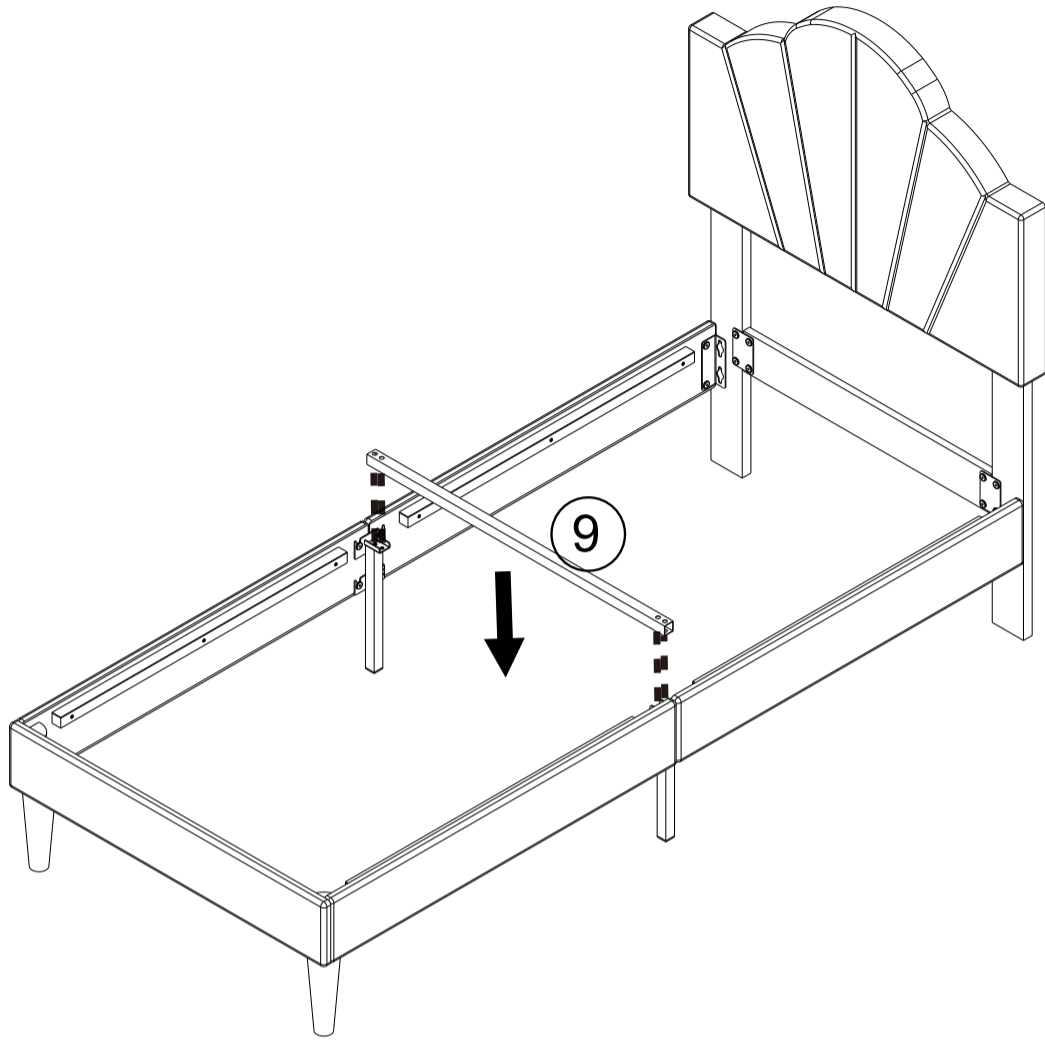

8

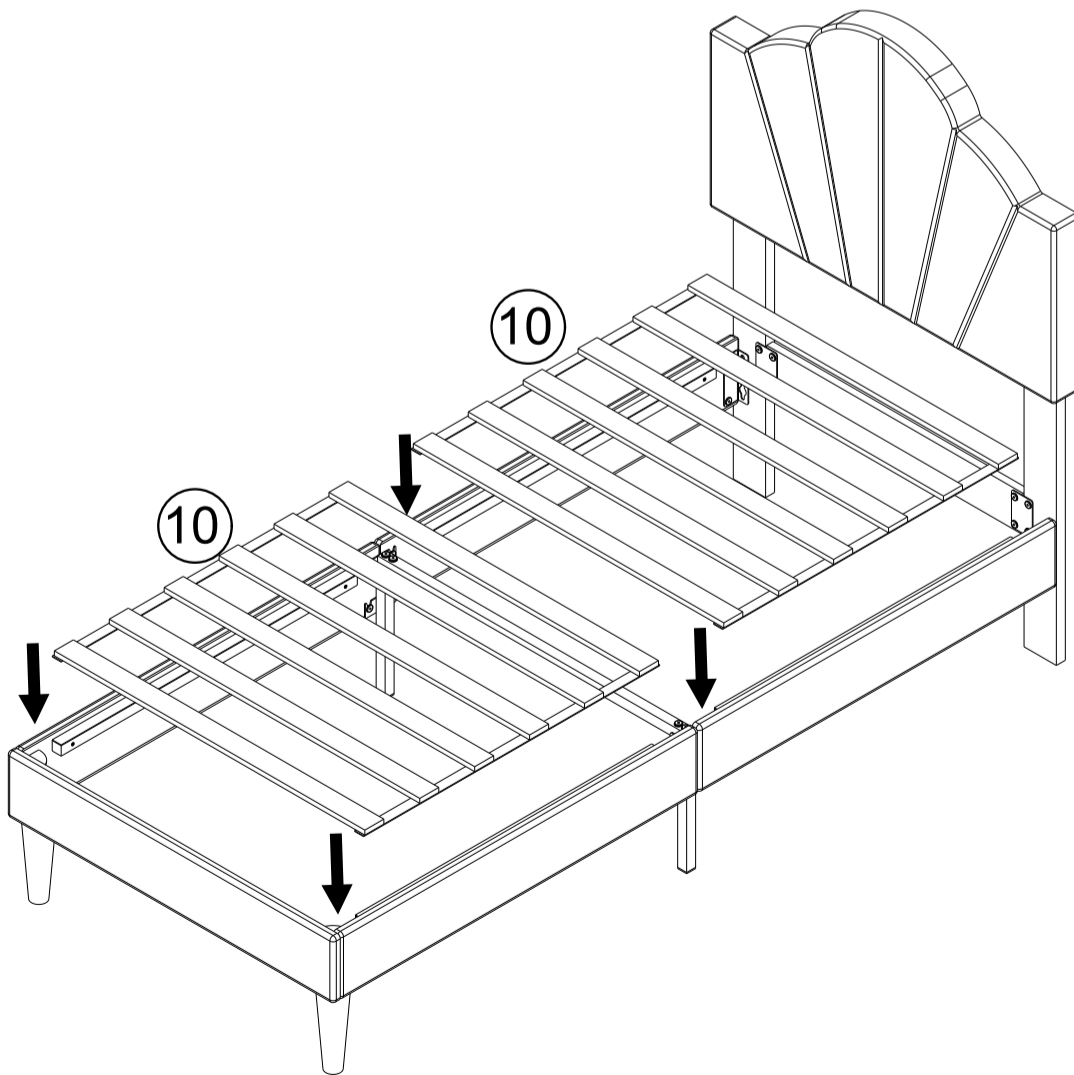

9

