

Assembly Instructions

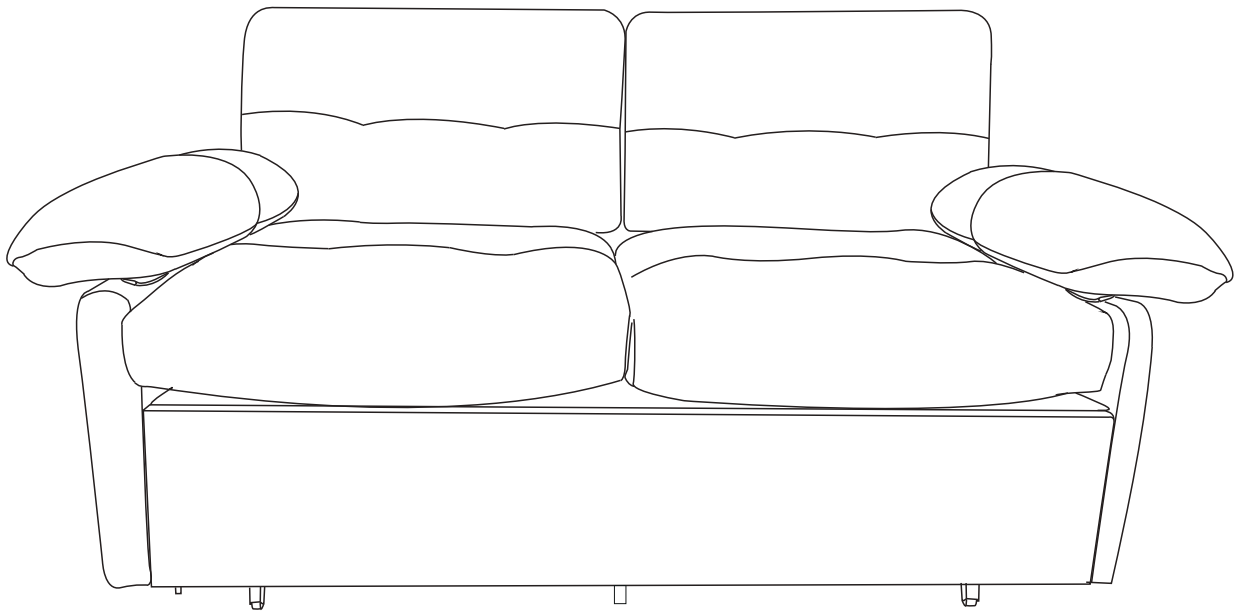



Safety and Care Advice

Important – Please read these instructions fully before starting assembly

Thanks for your purchase. Before the assembly. Please follow the instruction to check if all the spare parts and screws are intact.

- Considering the size and weight of the sofa, we recommend two adults to assemble the sofa, on a carpeted or padded area, in the room that it is intended for. Approximate assembly time: 30 minutes.
- Please do not throw away any of the packaging or the instruction until you have checked all the components and hardware and the furniture is fully assembled. Please ensure that the packaging is disposed in a safe and environmentally friendly way.
- Keep all components and packaging out of reach of children or animals to avoid risk of choking or suffocation.
- Please do not take off the cover, and do not wash.

Your cushions come vacuum packed and sealed for shipping. To restore the cushion's original shape. follow the steps below.

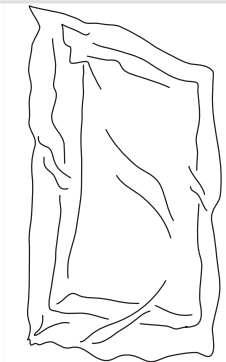

Open the vacuum bag carefully.



Press and tap with both hands from the side to fully inhale air

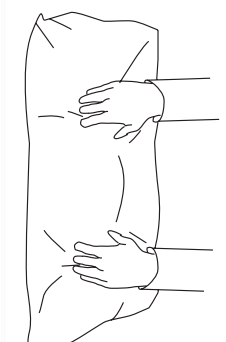

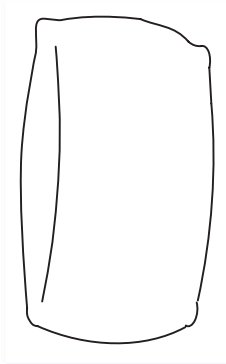

Press and tap with both hands from the front to fully inflate.



Carefully smooth out each section until the surface is even.

After packing up, place them in somewhere dry and ventilated. After about 72-96 hours. It can be restored to the best use condition.

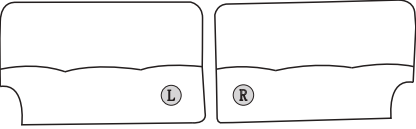
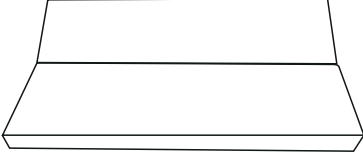
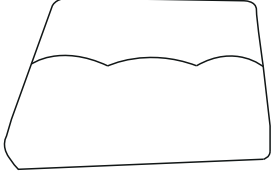
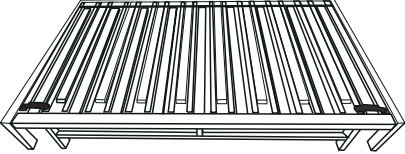
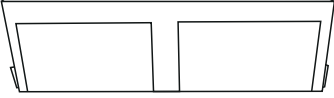
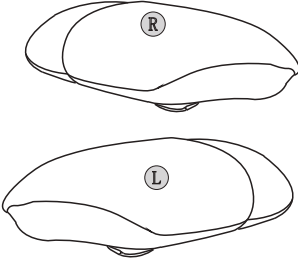
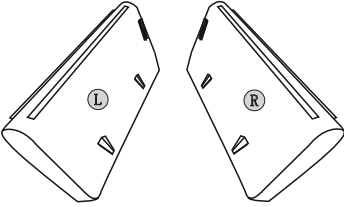
Components List

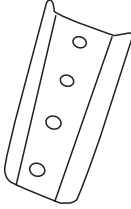
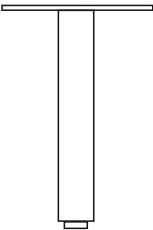
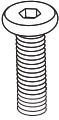
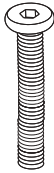
<p>A Back cushion</p>  <p>x2</p>	<p>B Sofa cushion</p>  <p>x1</p>	<p>C Seat cushion</p>  <p>x2</p>
<p>D Seat frame</p>  <p>x1</p>	<p>E Back board</p>  <p>x1</p>	<p>F Armrest bag</p>  <p>x2</p>
<p>G Armrest</p>  <p>x2</p>	<p>H Front board</p>  <p>x1</p>	<p>I Cone slot</p>  <p>x4</p>
<p>J Midfoot support</p>  <p>x1</p>	<p>a Screw M6 × 18mm</p>  <p>x10</p>	<p>b Screw M6 × 55mm</p>  <p>x2</p>

d Allen wrench

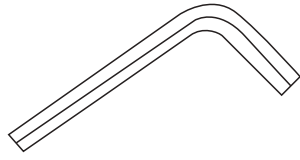

×1

Components Breakdown Diagram

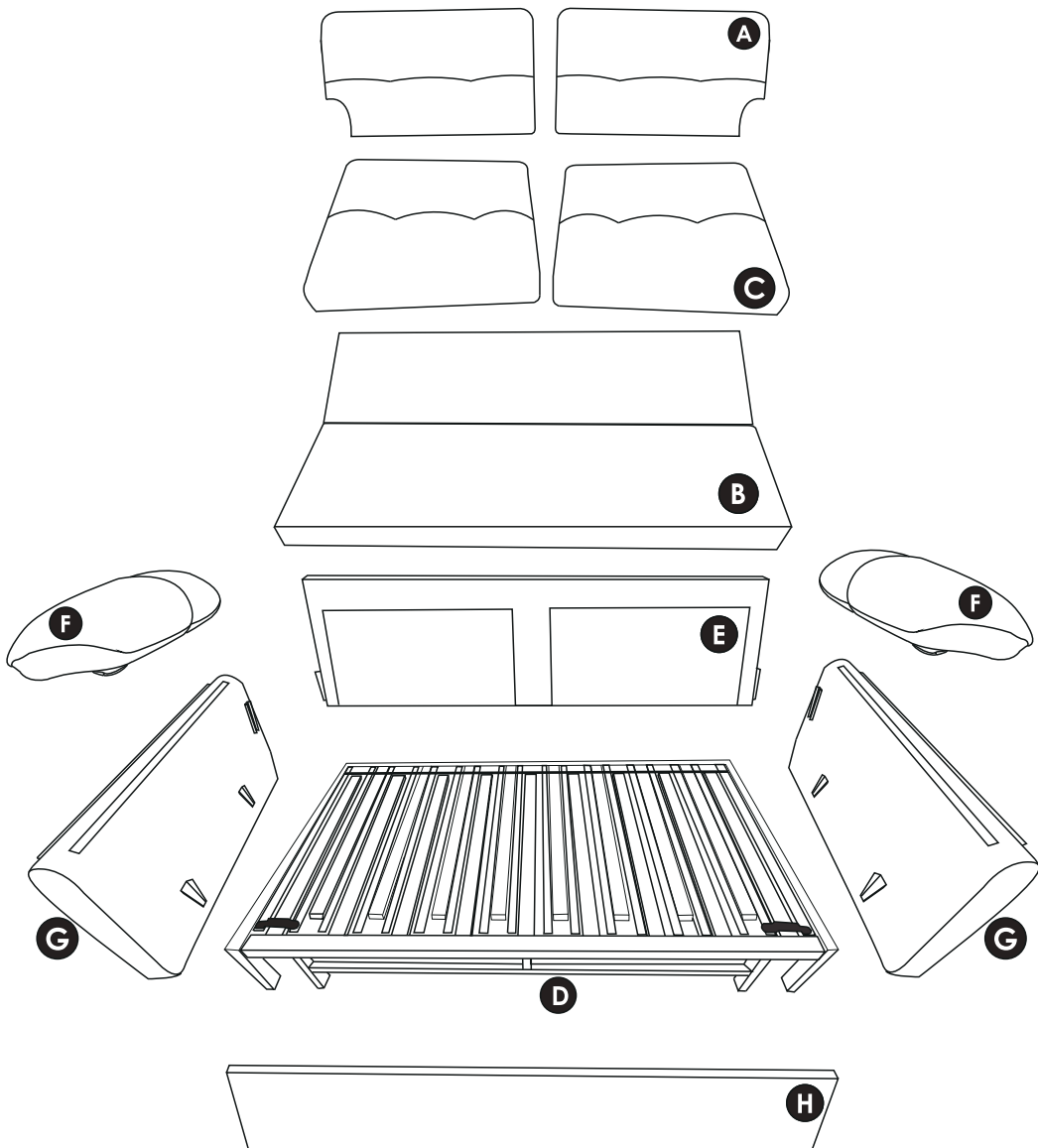

Assembly Instructions

STEP 1

Fix the cone slot separately on the seat frame.

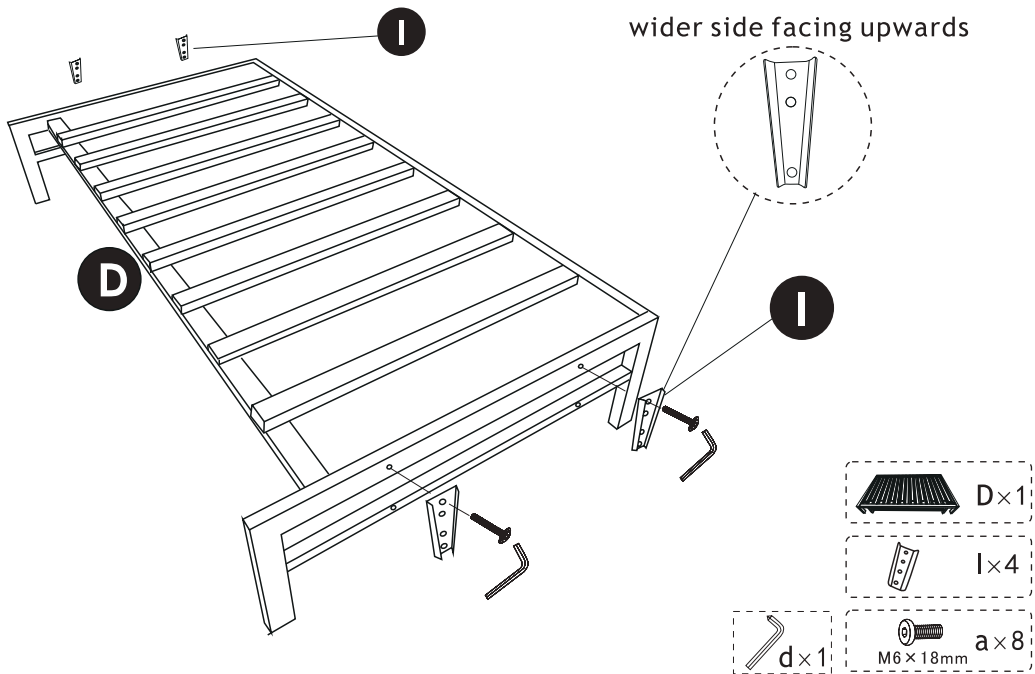

STEP 2

Reverse the seat frame and fix the midfoot support in the screw hole.

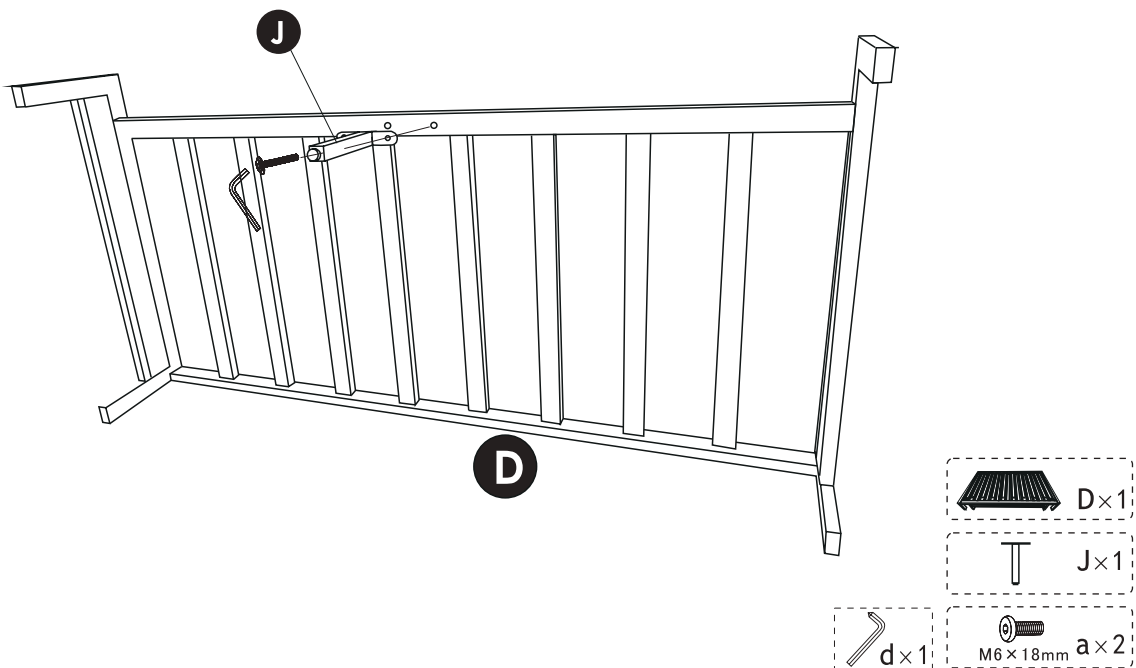

STEP 3

Attach the armrest to both sides of the seat frame.

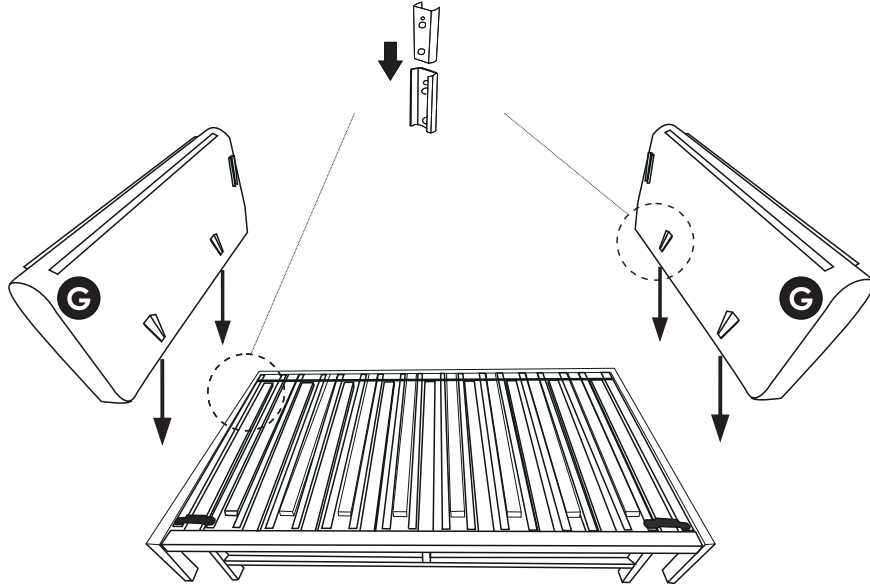

STEP 4

Attach the back board to the armrests.

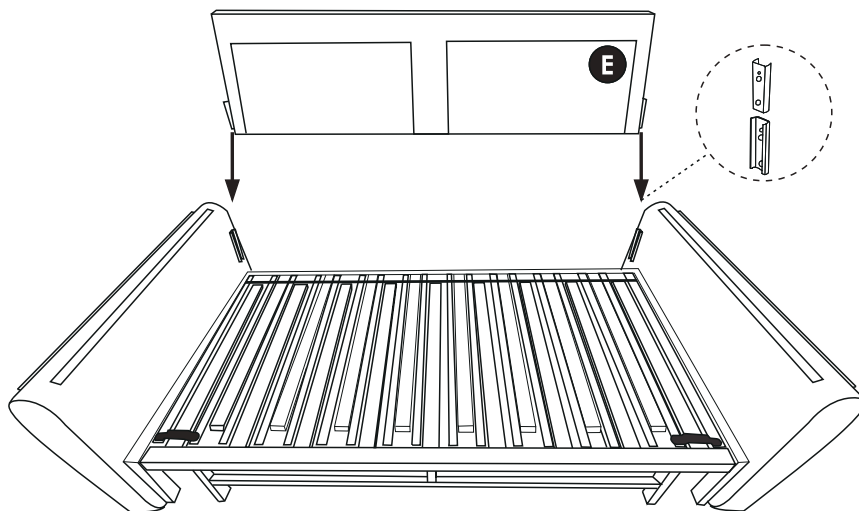

STEP 5

Pull out top two layers of seat frame, attach the front board to the upper lawyer, and place the sofa cushion.

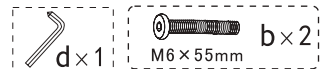
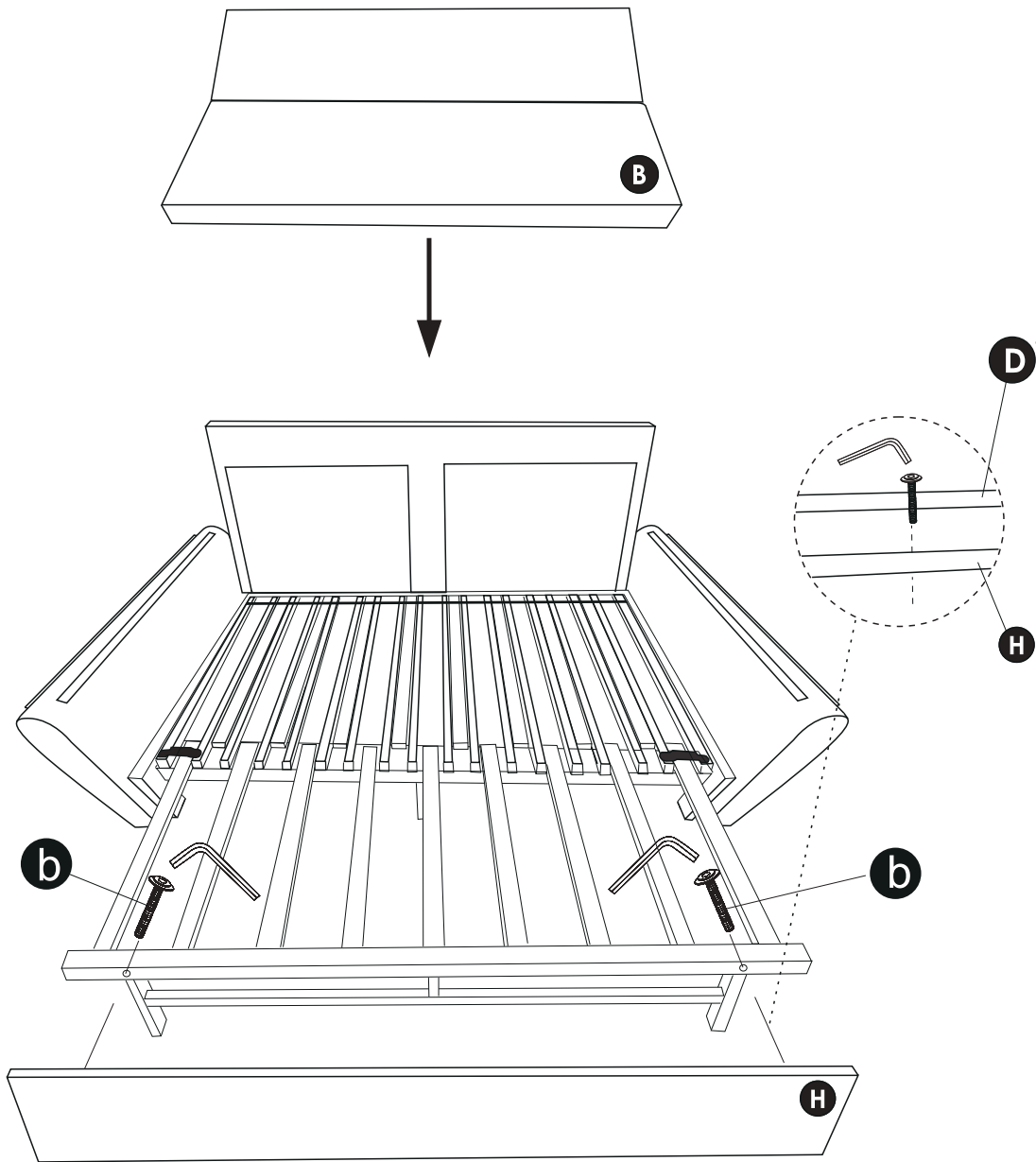

STEP 6

Connect the armrest bag to armrest with zipper and stripe, then sequentially place seat cushion, back cushion.

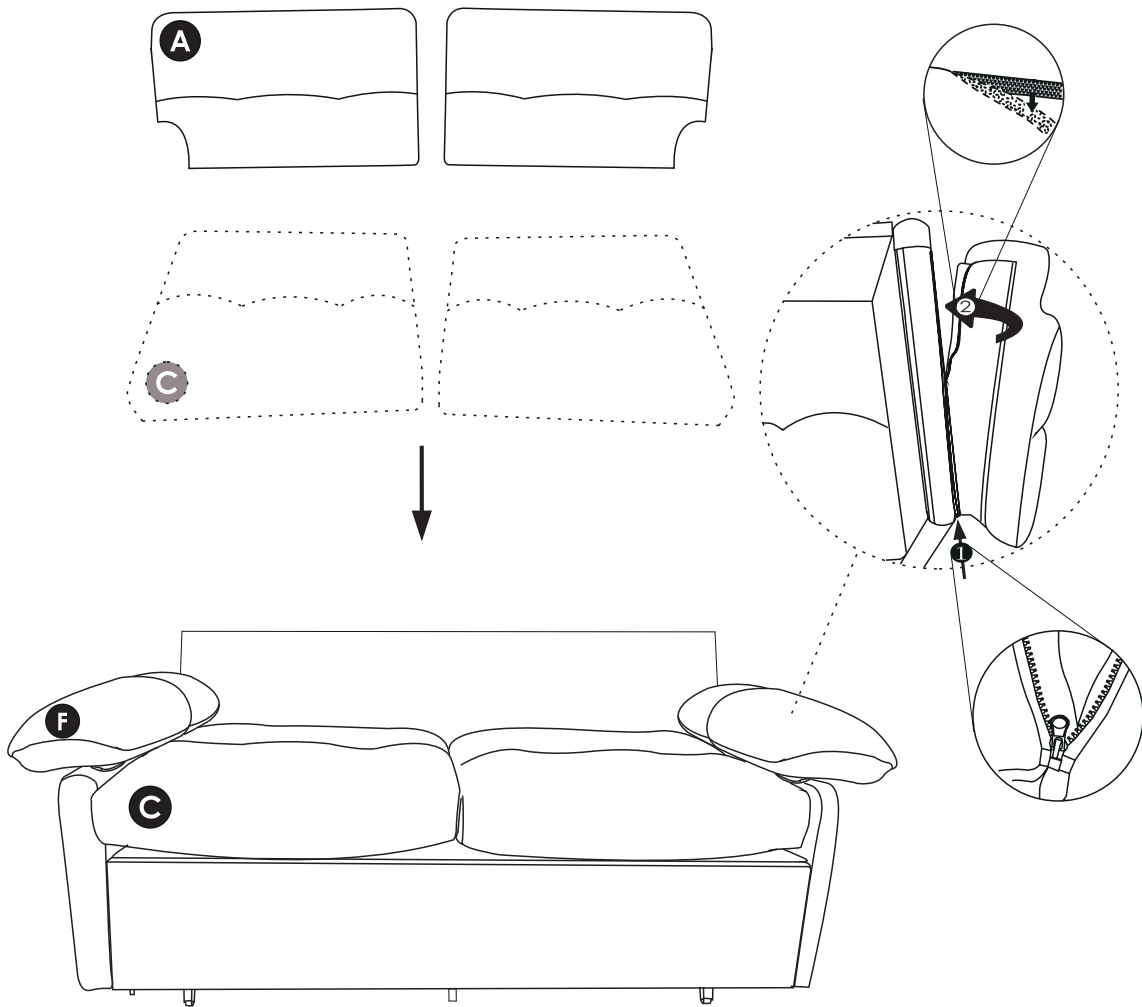

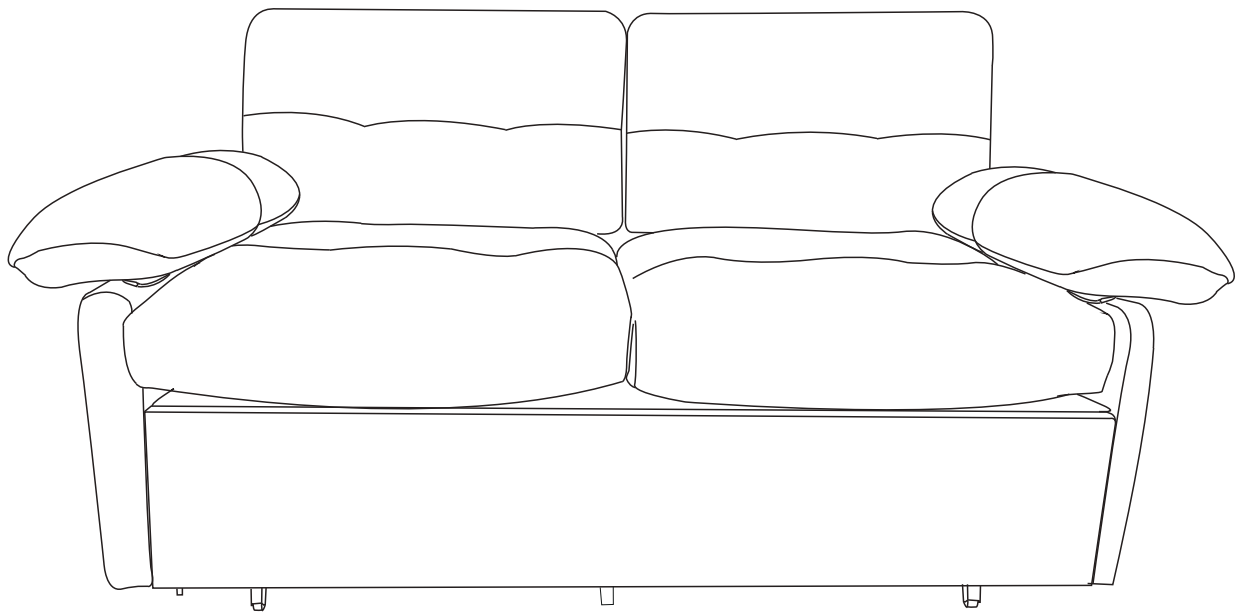
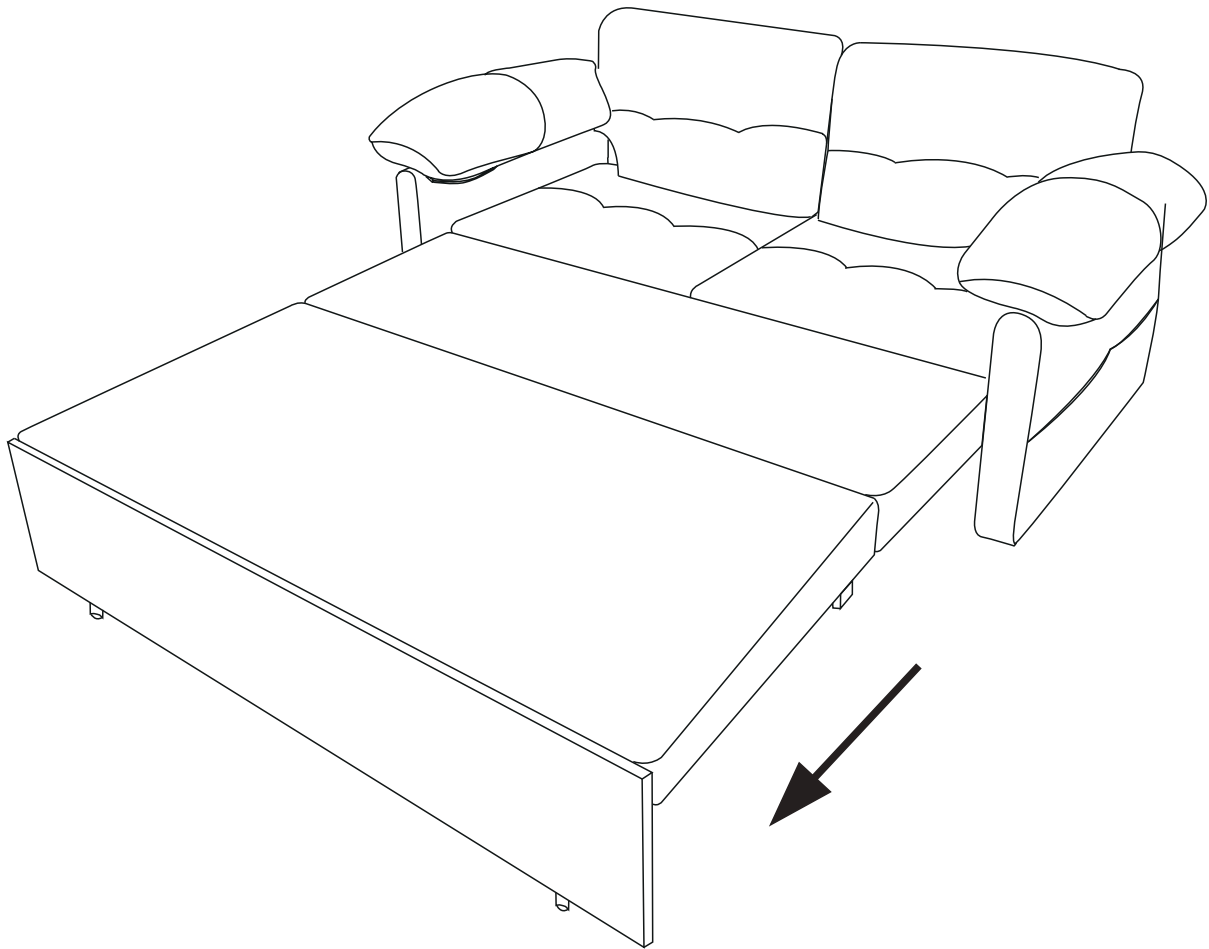

Installation completed after placement.