

Installation Manual

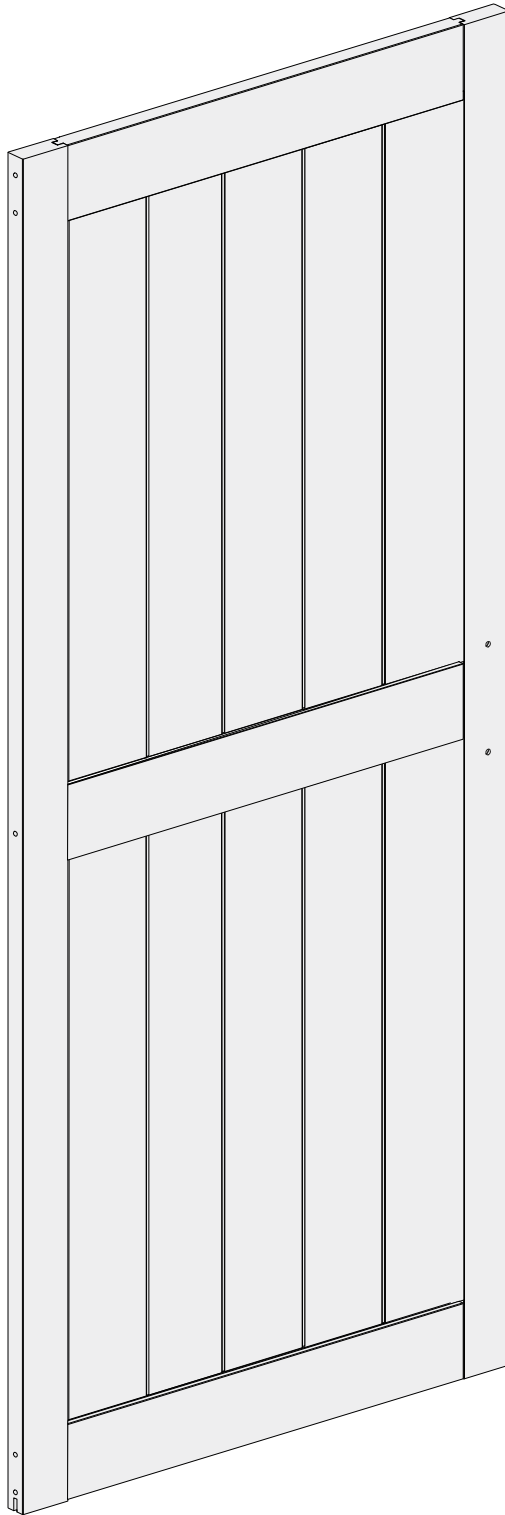

Components list

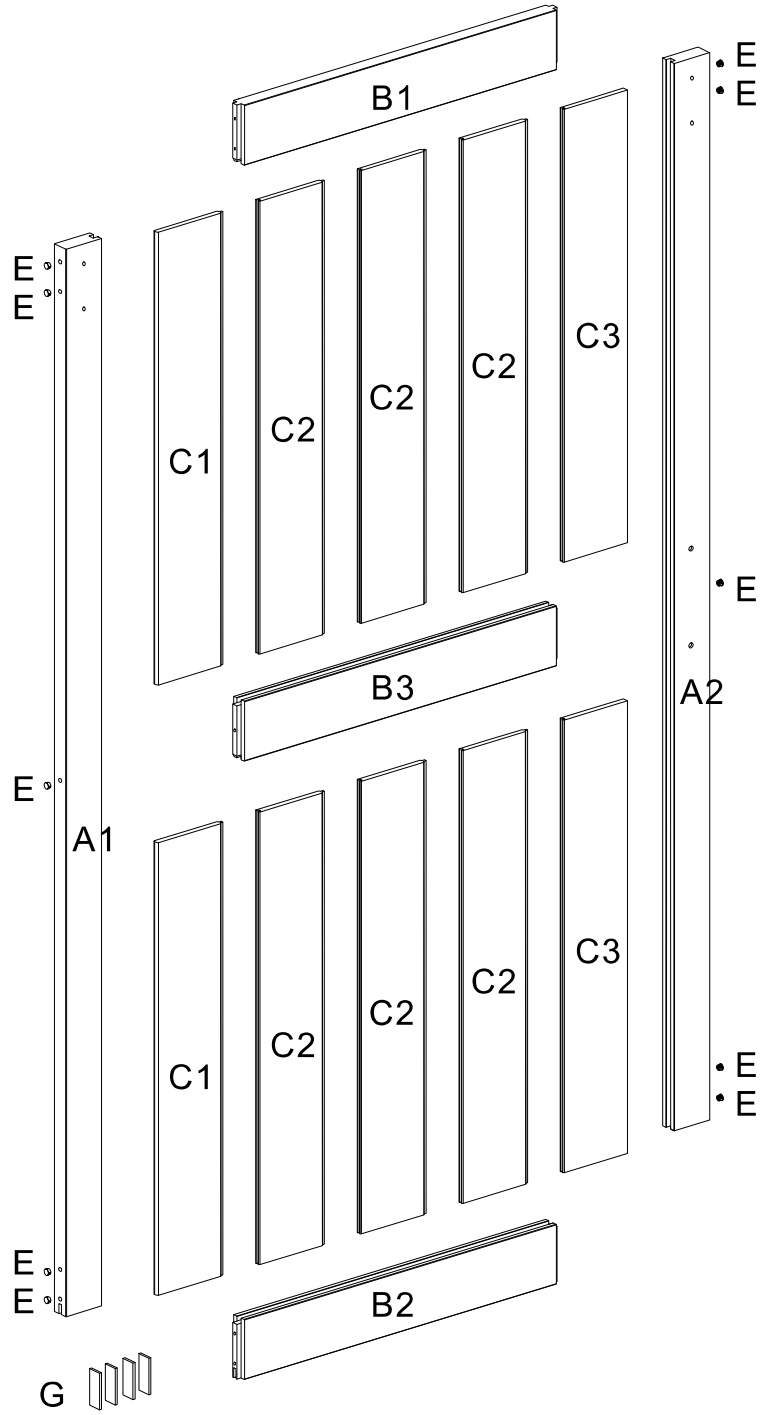

INSTRUCTIONS

H-Barn Door Installation Instruction

Package List

A1	Side Stile	*1
A2	Side Stile	*1
B1	Top Rail	*1
B2	Bottom Rail	*1
B3	Middle Rail	*1
C1	Left Side Slat	*2
C2	Middle Side Slat	*6
C3	Right Side Slat	*2
D	Carriage Bolt	*10
E	Plastic Cap	*10
F	Washer	*10
G	Gasket	*4
	Spanner	

Stile and Slat End Views

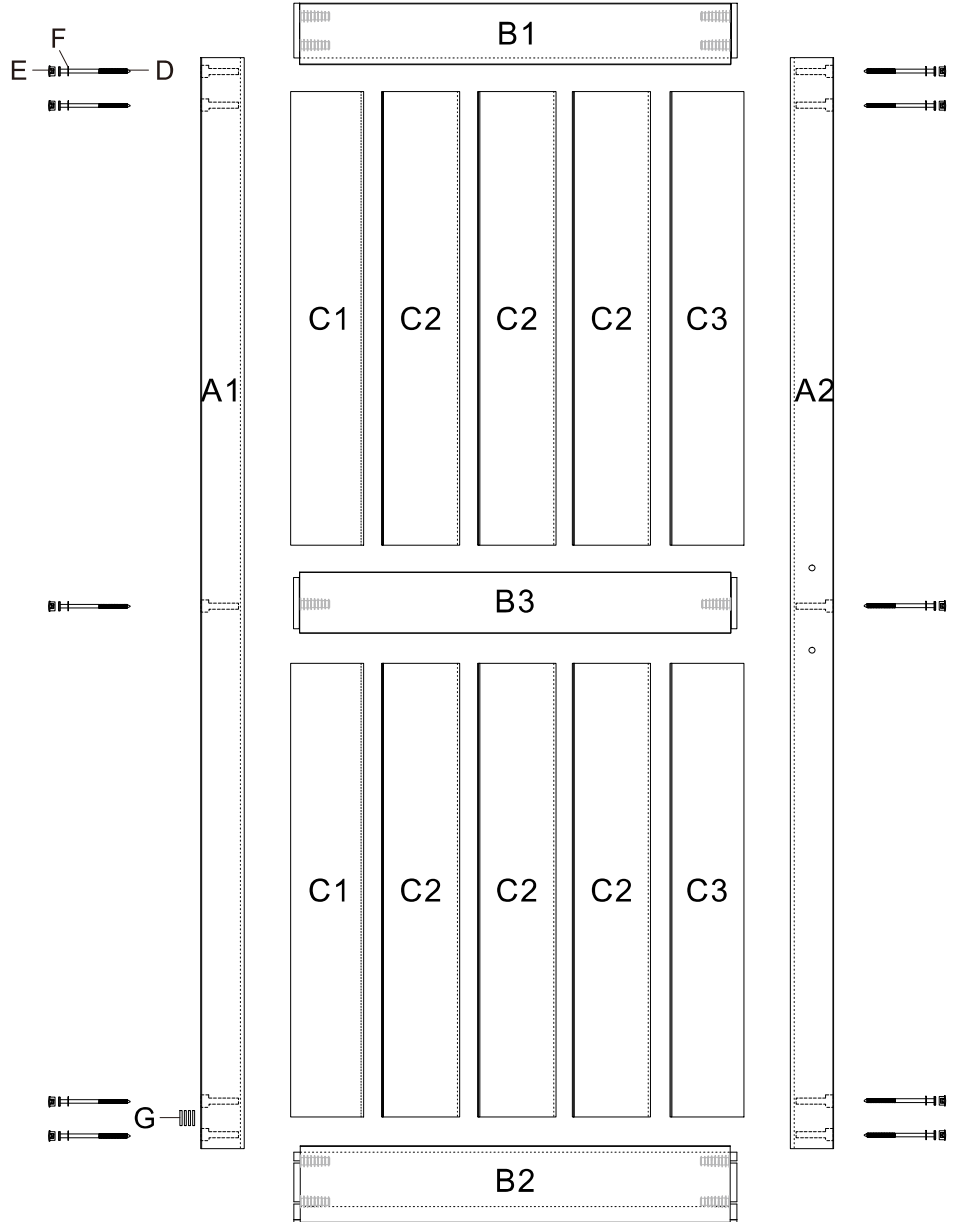
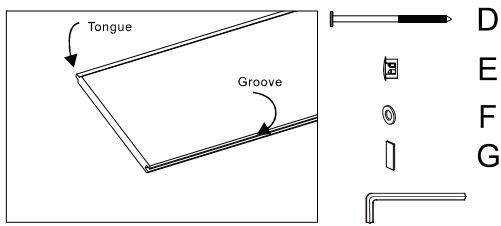
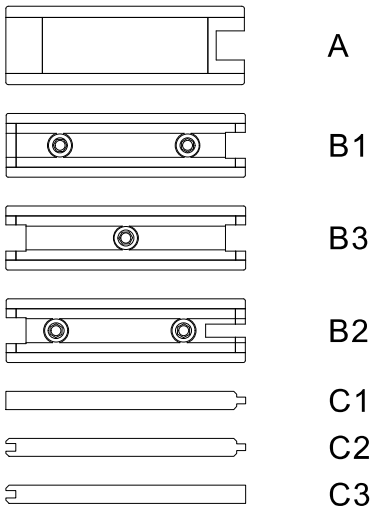

Note: Gasket(H) is spare. If the door core board is loose, add 4 gaskets in the groove at bottom of side stile.

Step 1.

Lay out **Side Stile A1** on flat, clean surface. Make sure the groove side is to the inside.
Attach **B1 Top Rail**, **B2 Bottom Rail** and **B3 Middle Rail** to **Side Stile A1** by inserting the tongues into the groove of A and fasten with carriage bolts.

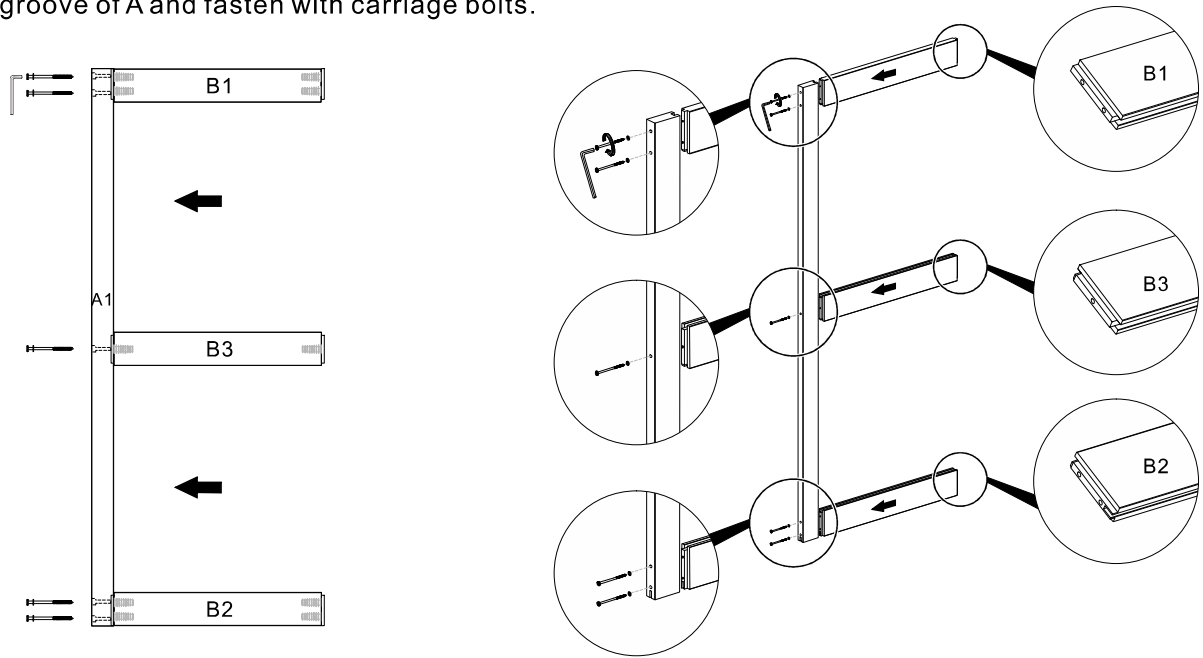

Step 2.

Assemble **C1 Left Side Slat**, **C2 Middle Side Slat**, **C3 Right Side Slat** as shown in figure.
Make sure C1 tongue facing inside, C2 next to C1 with the tongue facing inside,
C3 next to the last C2 with flat side inside.

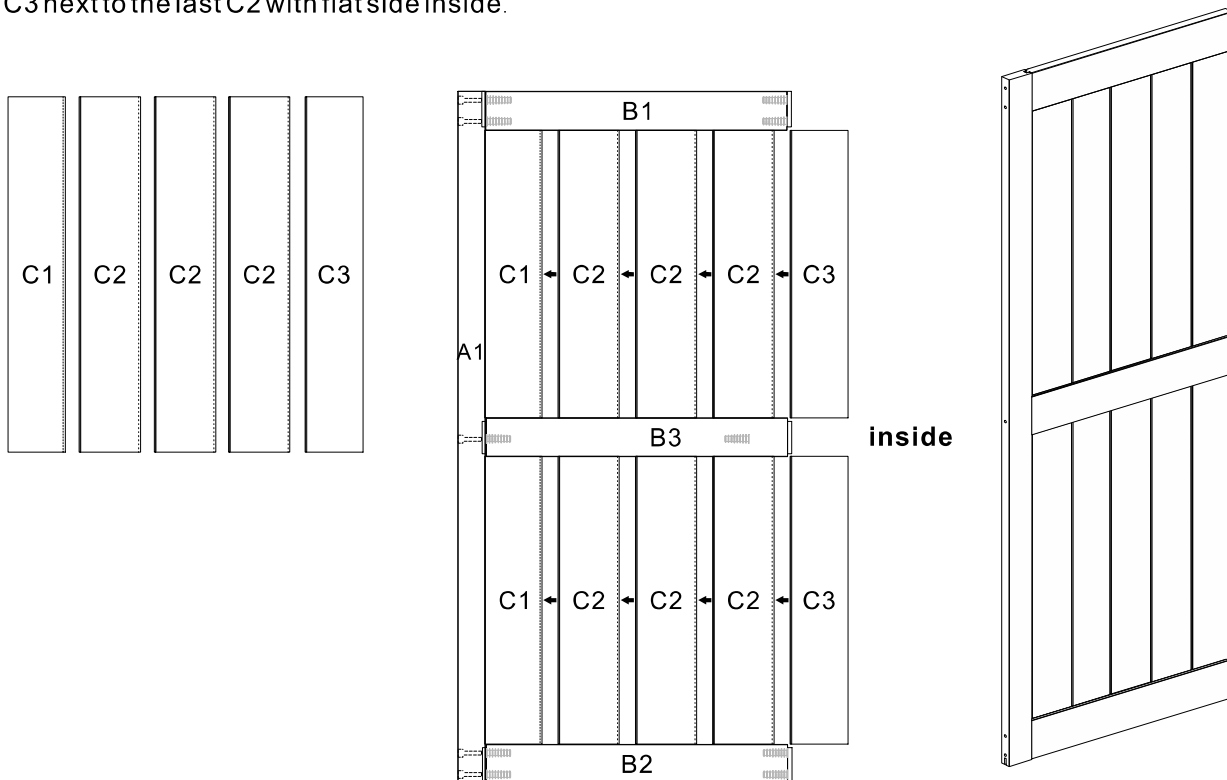

Step 3.

Place the other **Side Stile A2** beside the assembled **Rails** and **Side Slats** by inserting the rails' tongues to the groove of **A2** and fasten with carriage bolts.

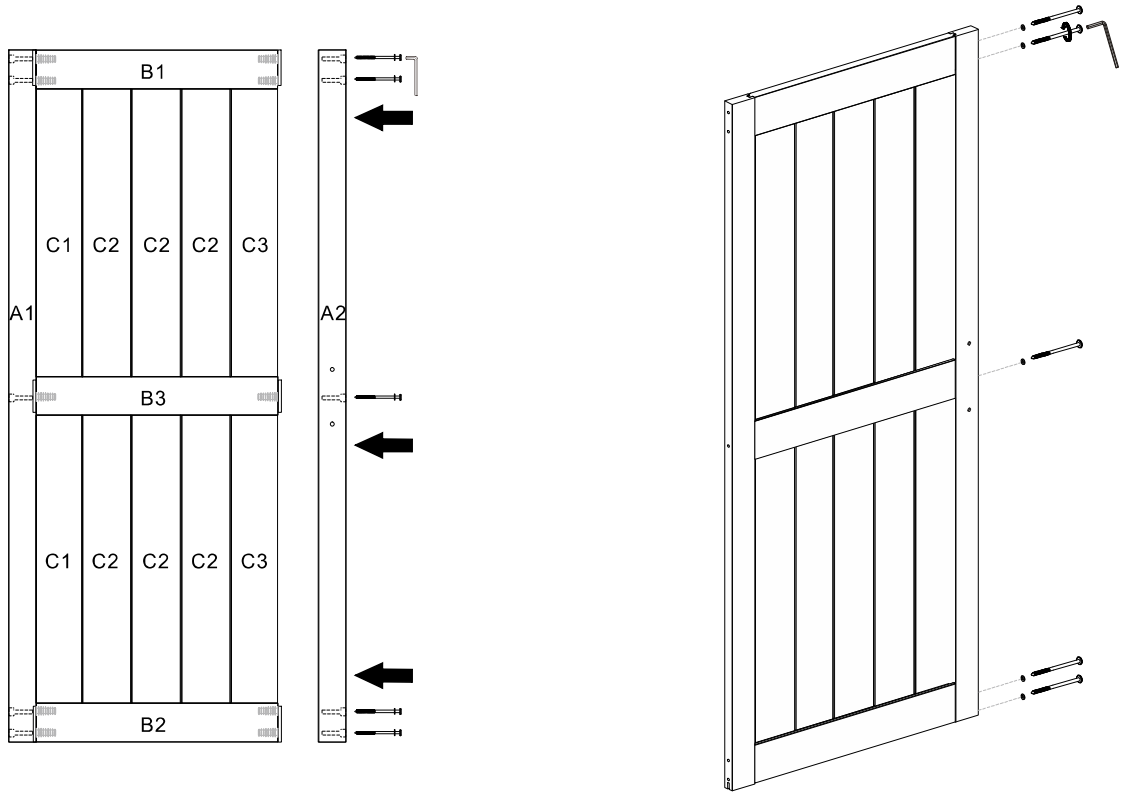

Step 4.

Make sure all bolts are tightened, place **E Plastic Caps** on top of the bolts and flush with Side Stile surface.

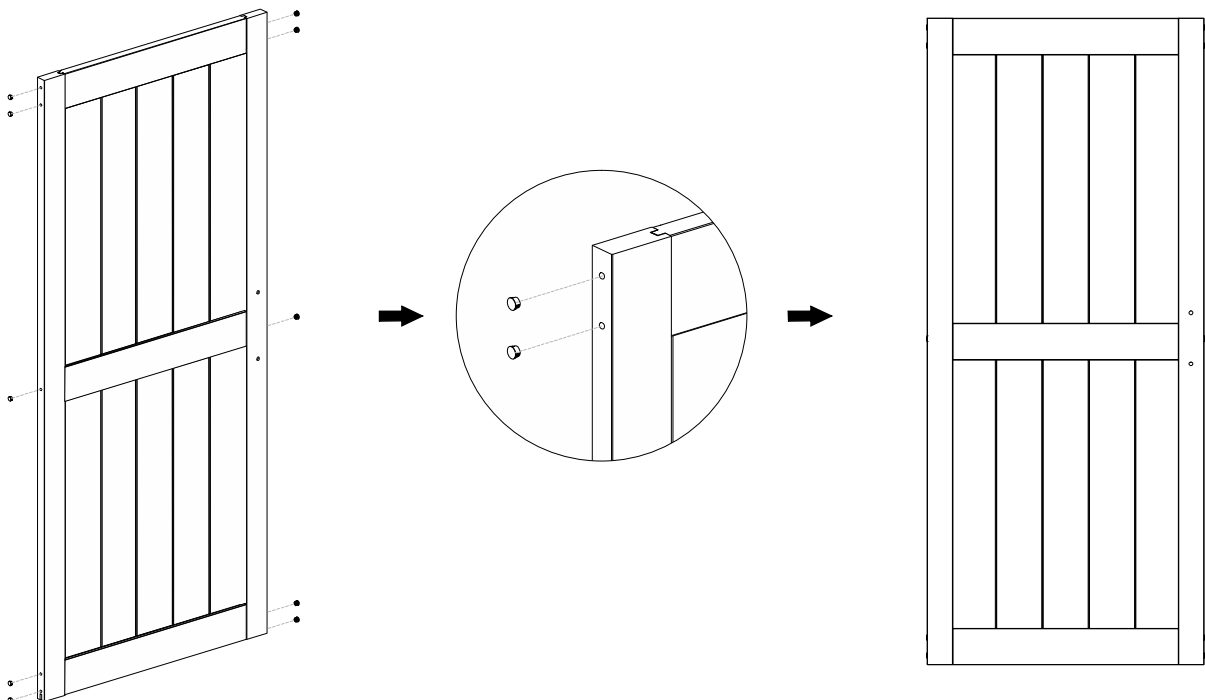

Installation Manual

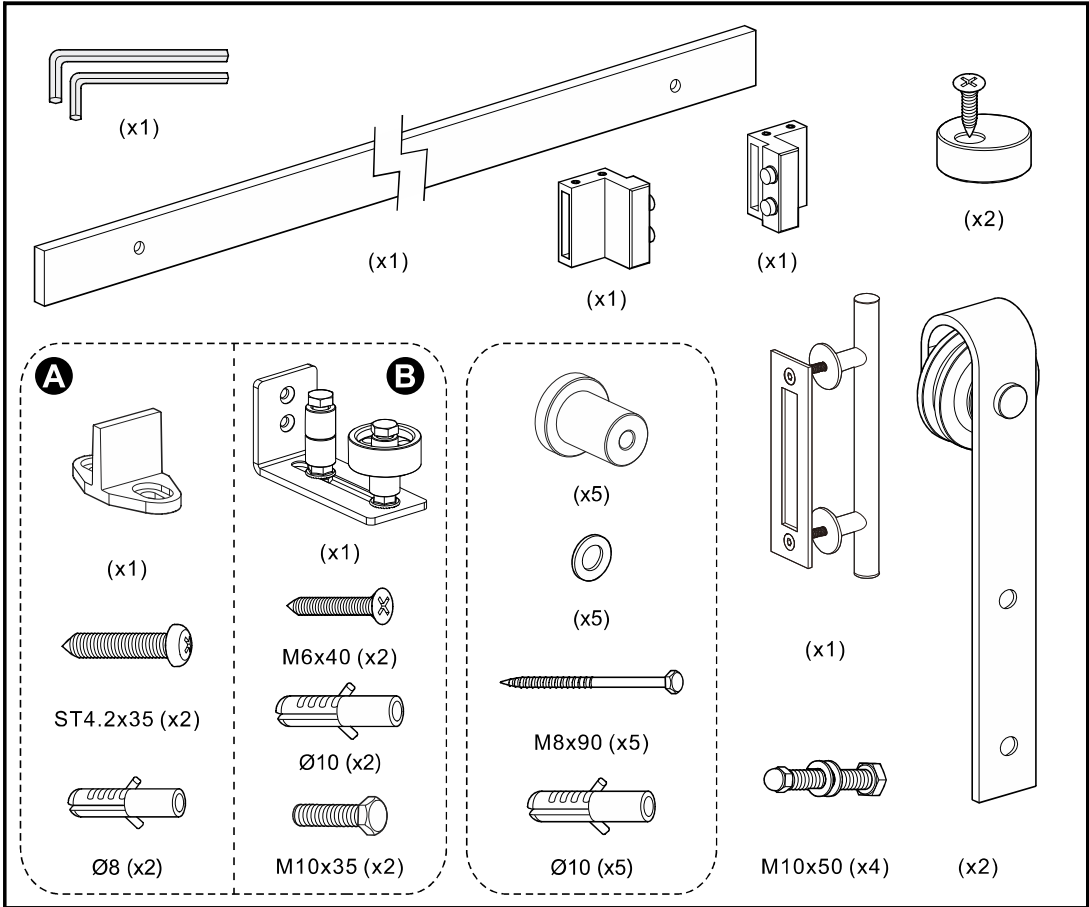
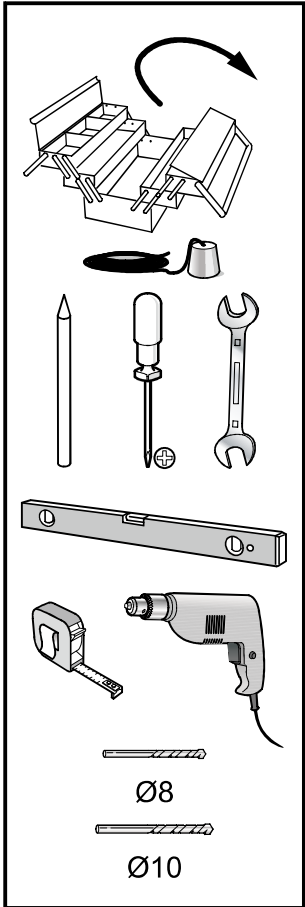
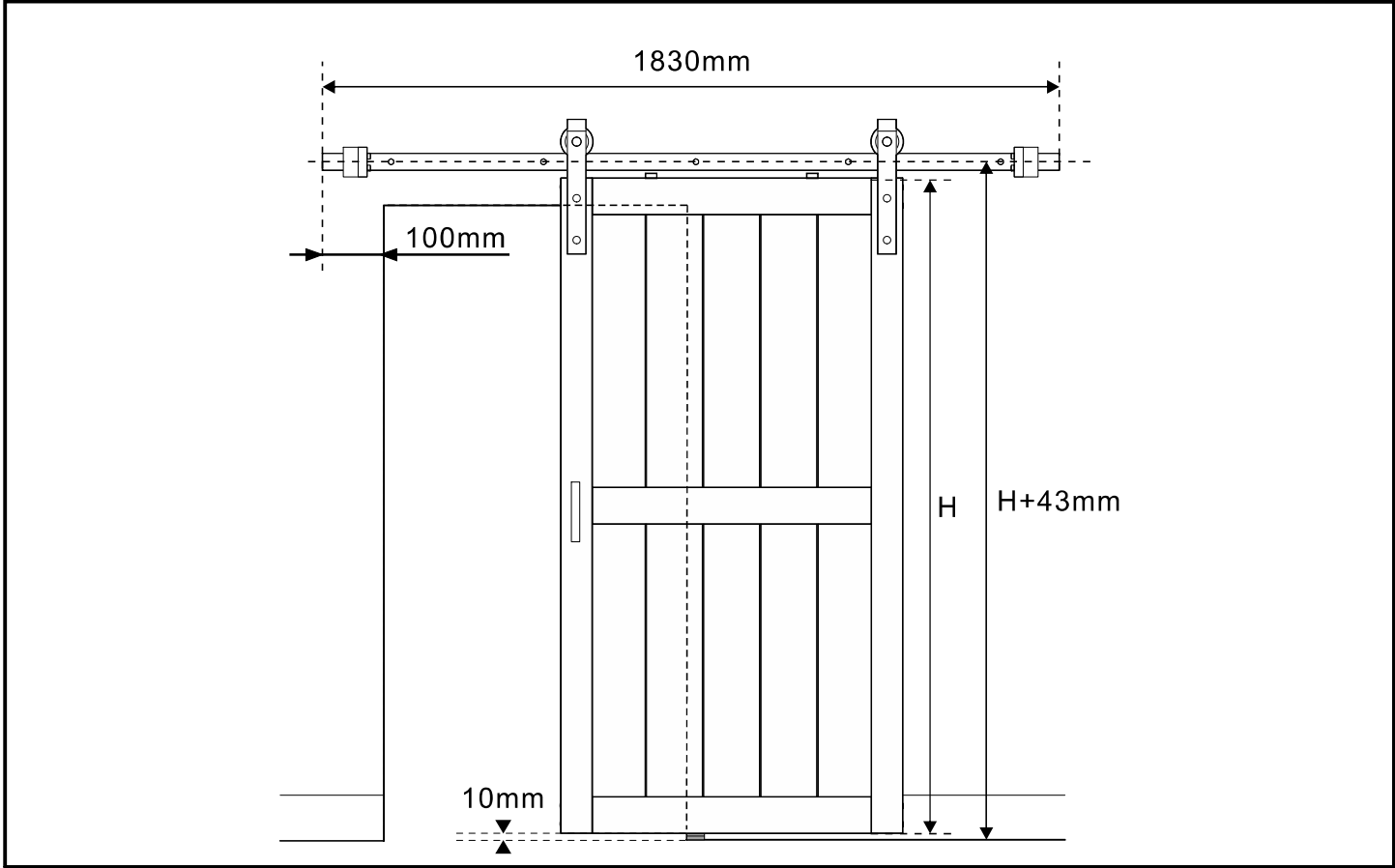

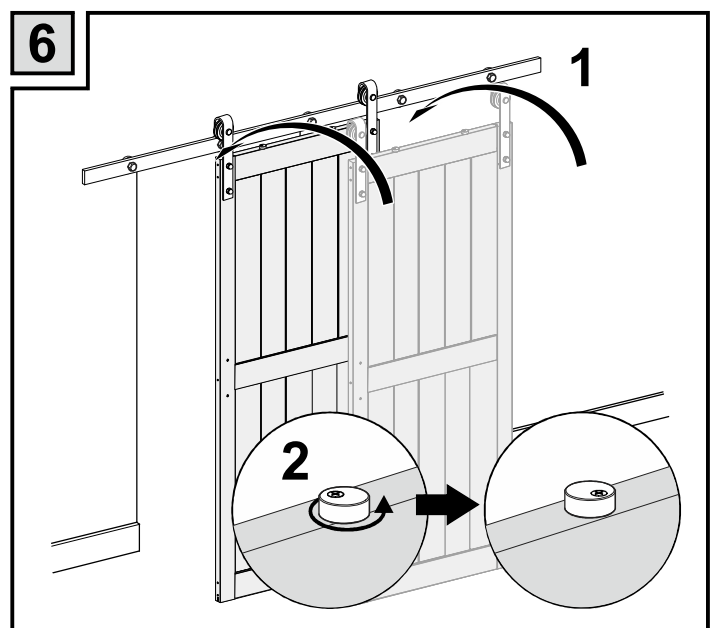
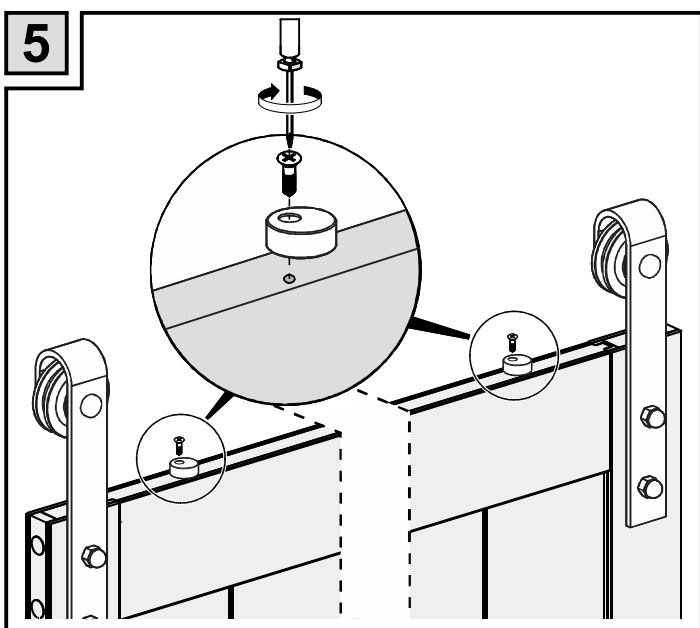
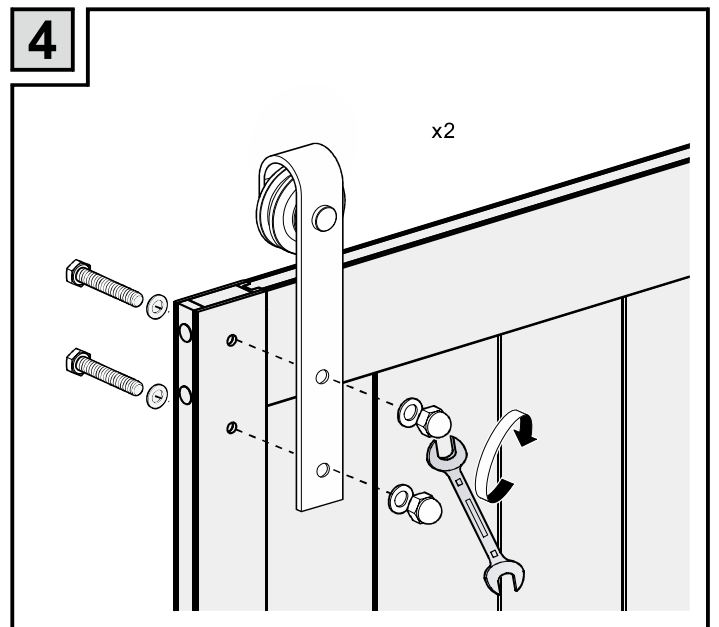
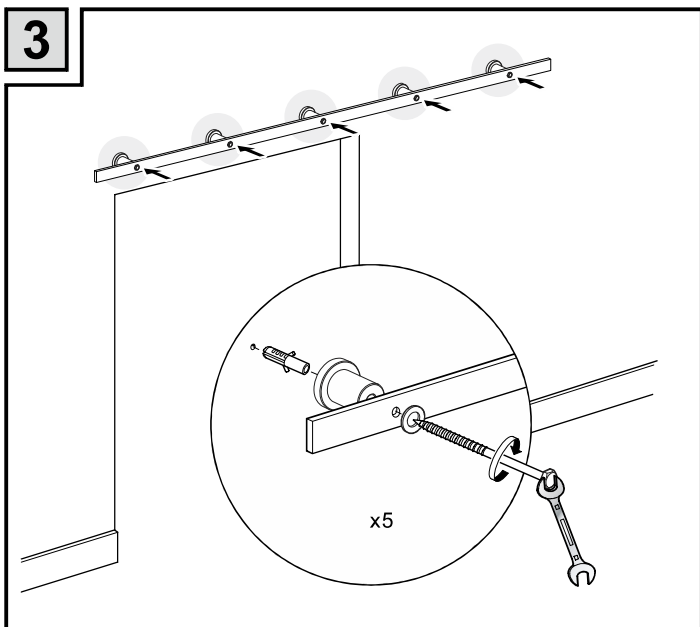
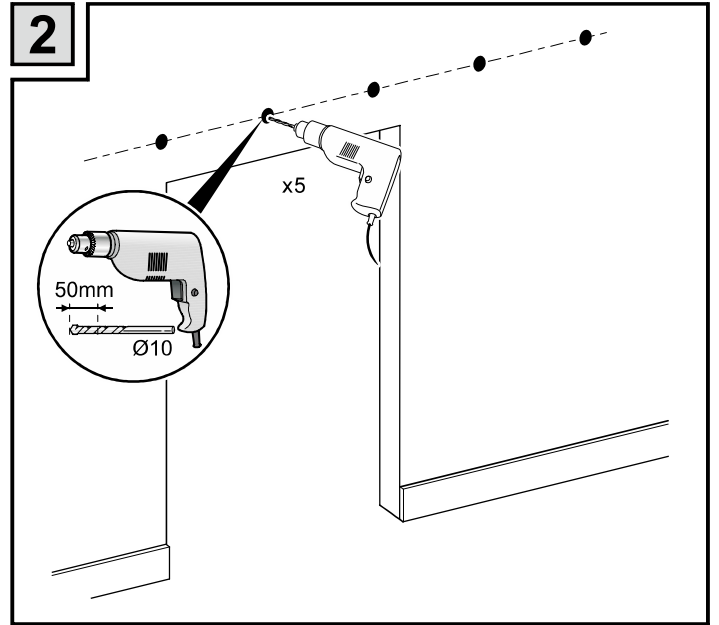
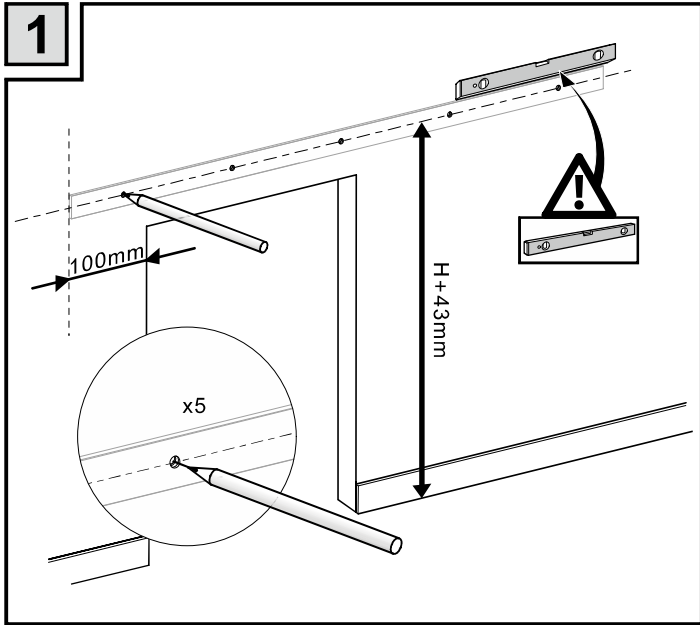

7A

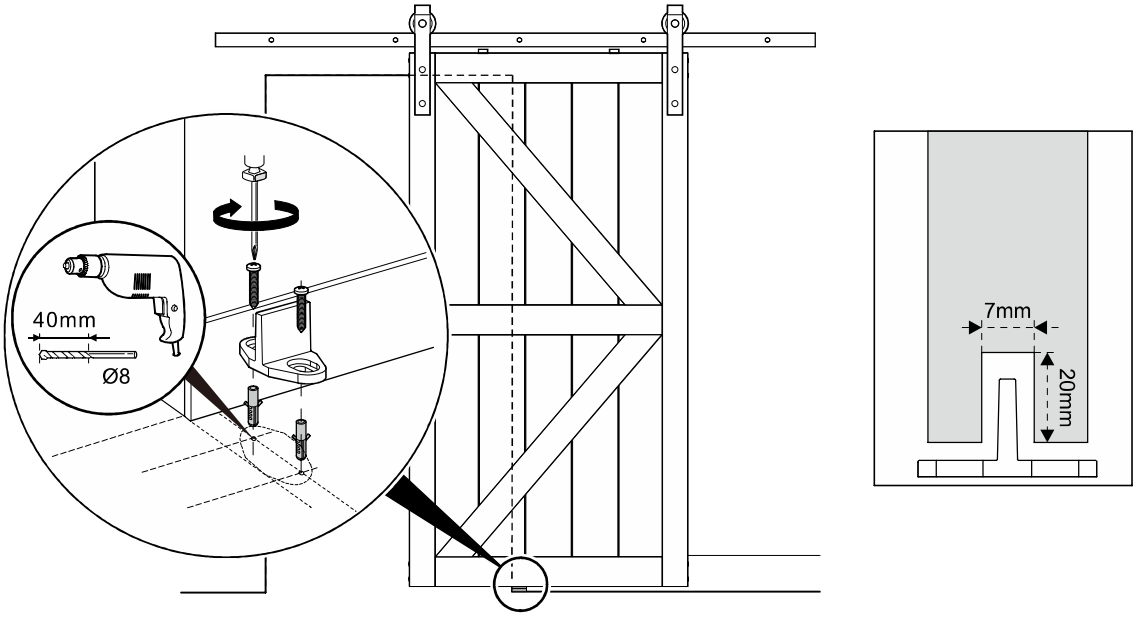

7B

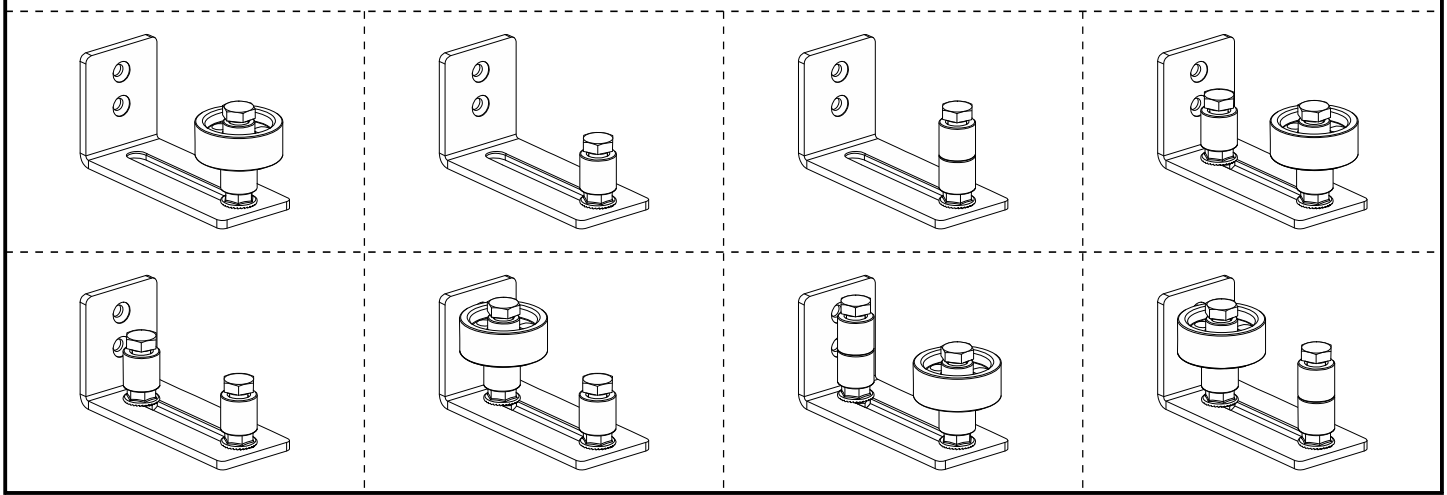
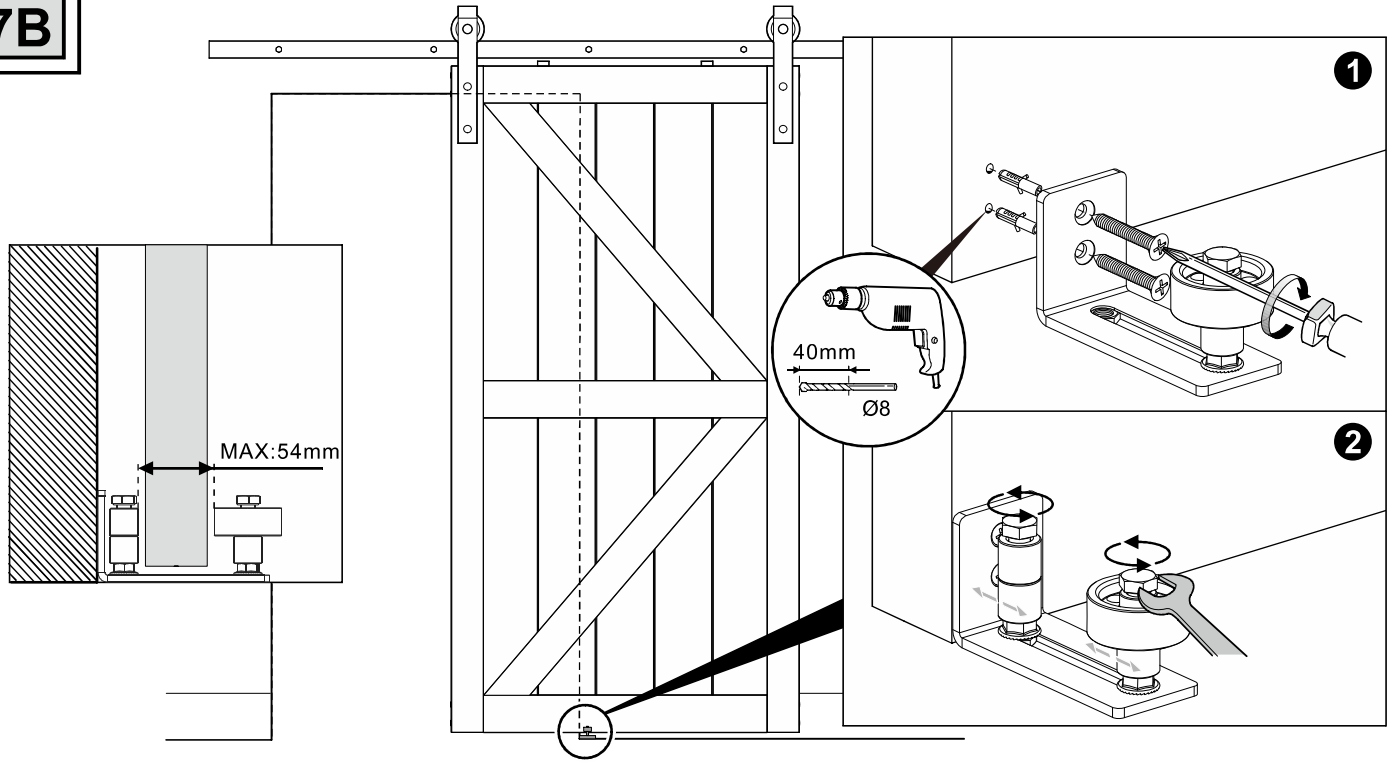

8

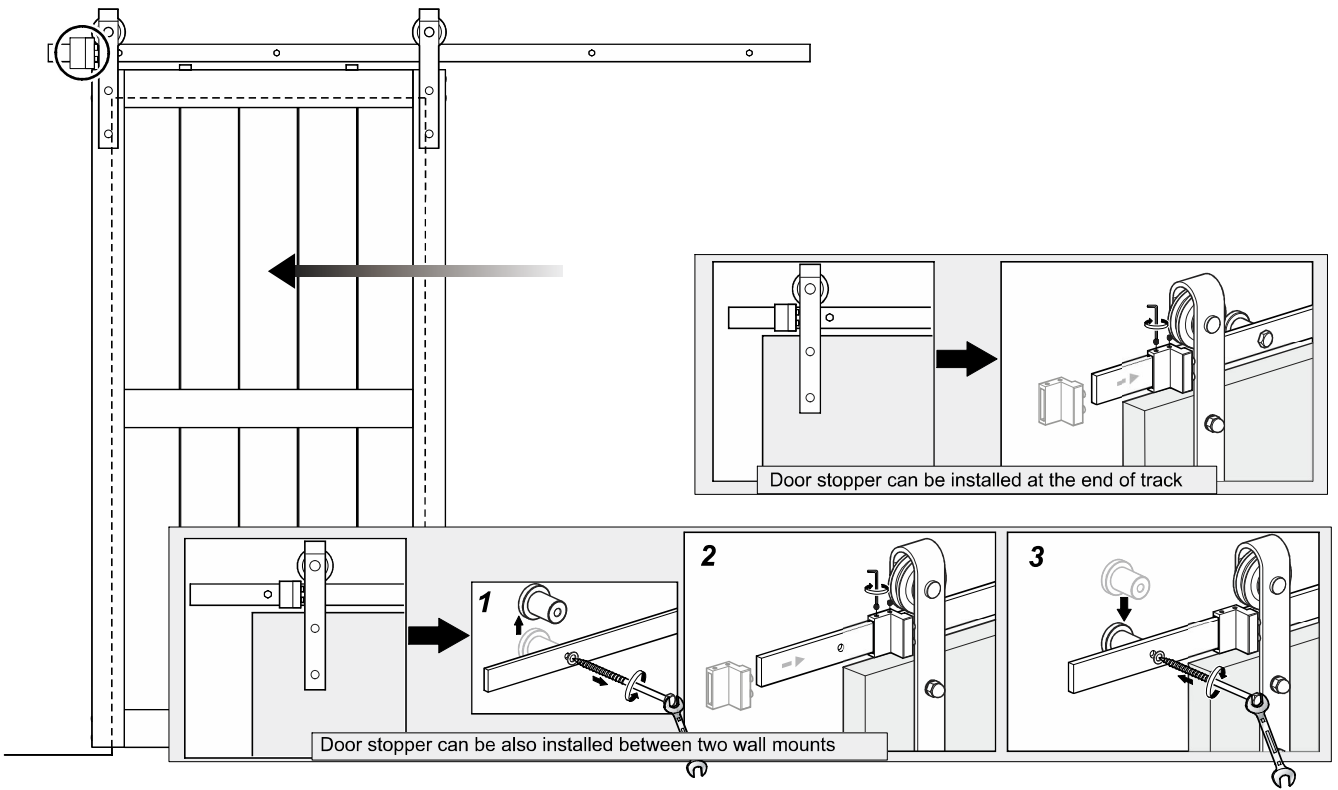

9

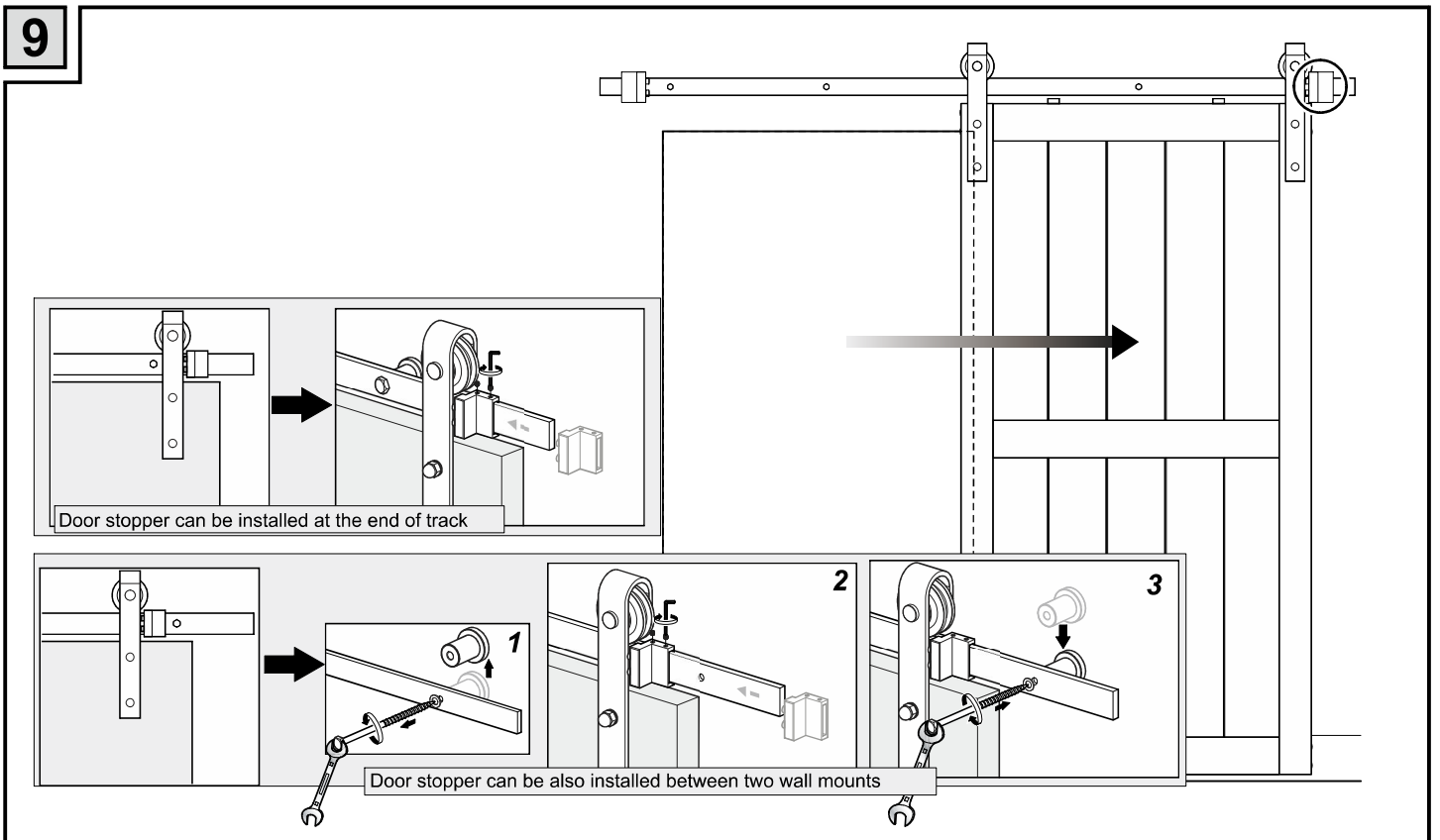

10

