

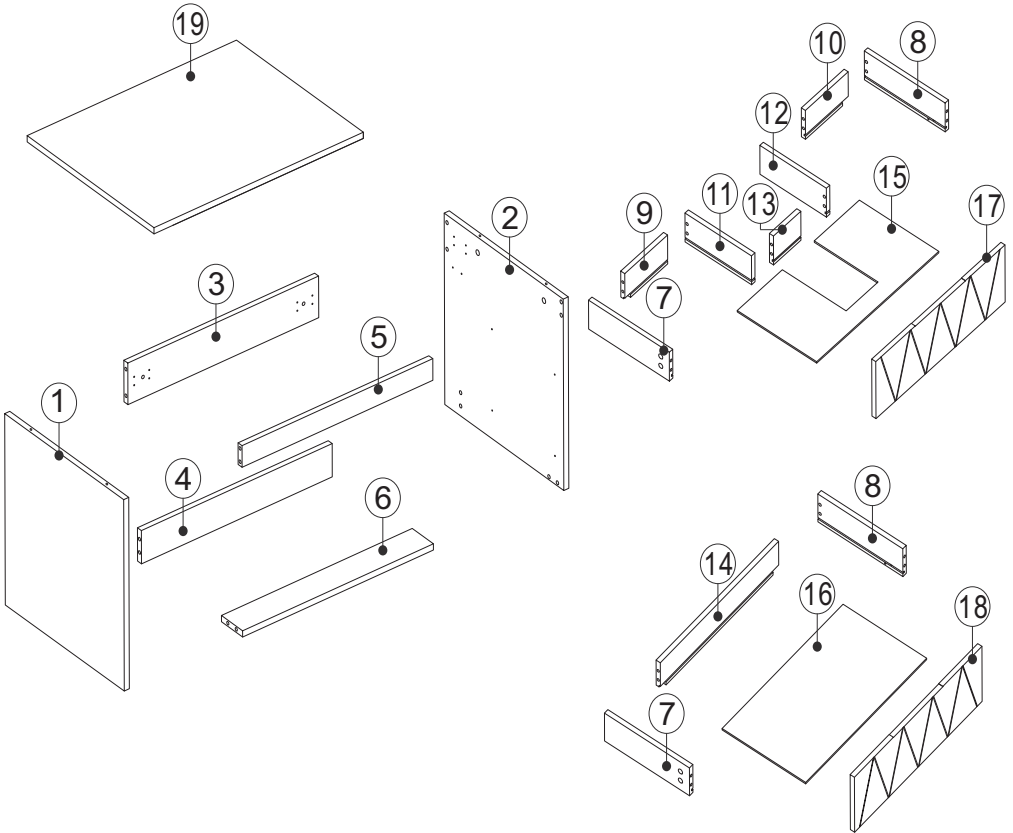



























INSTALLATION INSTRUCTIONS

ASSEMBLY DIAGRAM



PARTS LIST

PARTS LIST			HARDWARE LIST		
No.	Description	QTY	No.	Description	QTY
1		1	20	 Three-in-one Connector	44
2		1	21	 Screws	24
3		1	22	 Handle	2
4		1	23	 R L Slider	2
5		1	24	 Hanger	2
6		1		 ST4×30 Screws	4
7		2		 ST4×50 Screws	6
8		2	25	 Bracket	2
9		1	26	 Screws For Fix On The Wall	2
10		1			
11		1			
12		1			
13		1			
14		1			
15		1			
16		1			
17		1			
18		1			
19					

CAUTION: Please confirm the parts list before installation

YOU MAY NEED (NOT SUPPLIED)

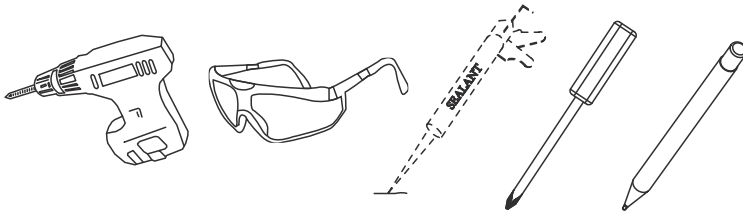

INSTALLATIONS

STEP 1

HARDWARE LIST

20		44 PCS	
----	---	--------	--

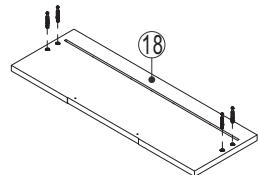
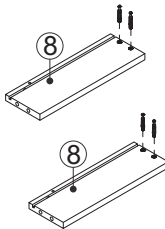
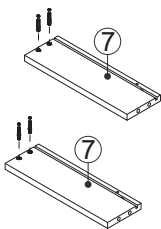
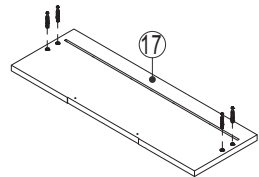
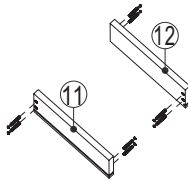
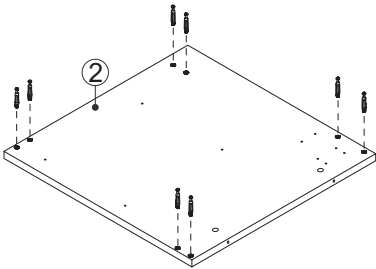
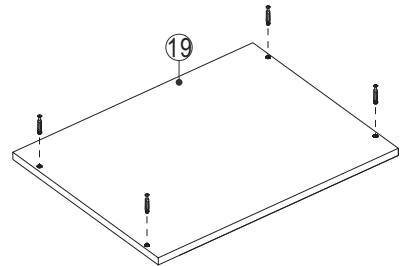
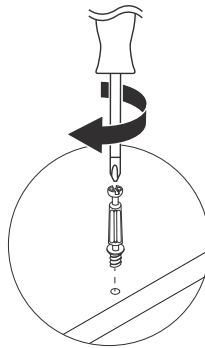
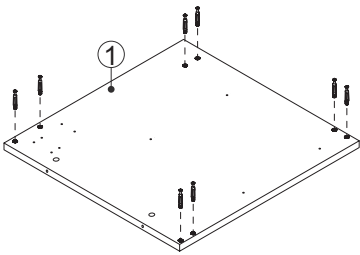

● Insert the Cam Screw into the shelves above.

STEP 2

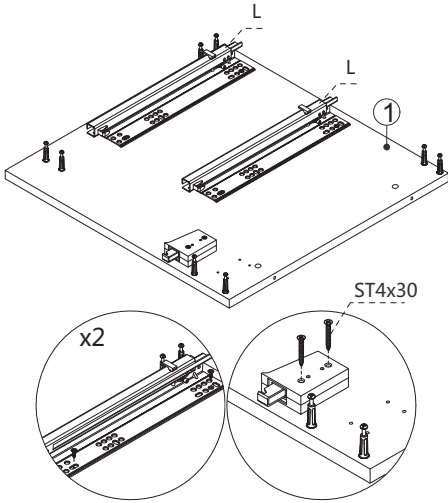

HARDWARE LIST	
⑳	8 PCS
㉓	2 PCS
㉔	2 PCS
㉔ (ST4x30)	4 PCS

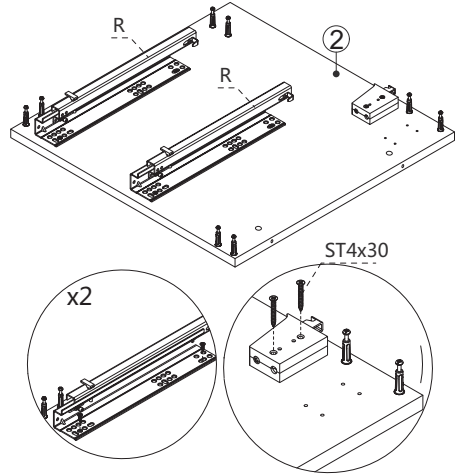

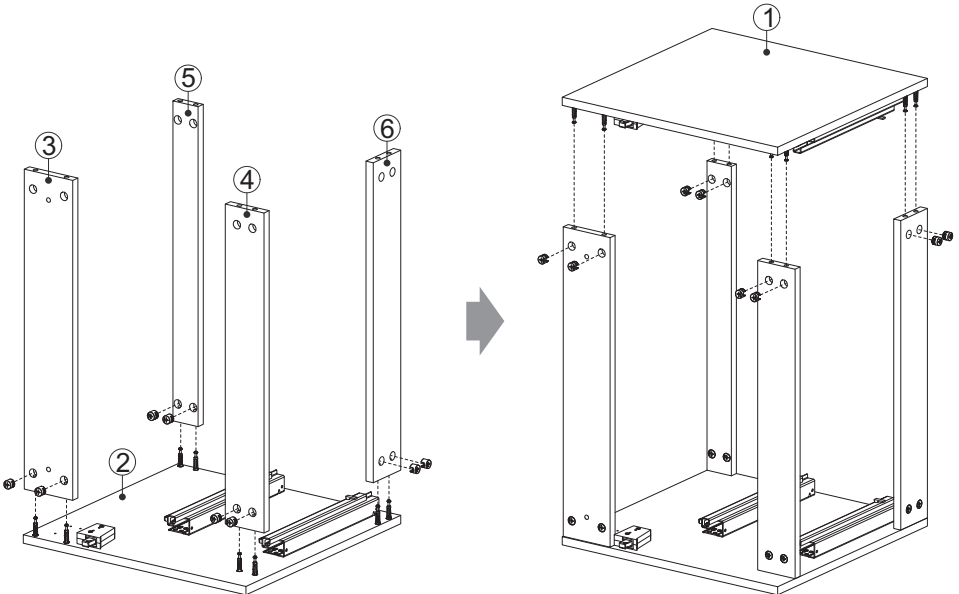

STEP 3

HARDWARE LIST	
㉔	16 PCS





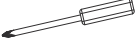
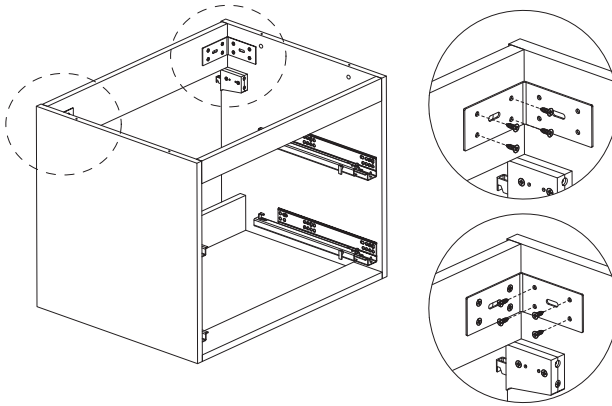

STEP 4

HARDWARE LIST		
25		2 PCS
21		16 PCS

STEP 5

HARDWARE LIST		
20		16 PCS
22		2 PCS
22		1 PCS

STEP 6

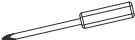
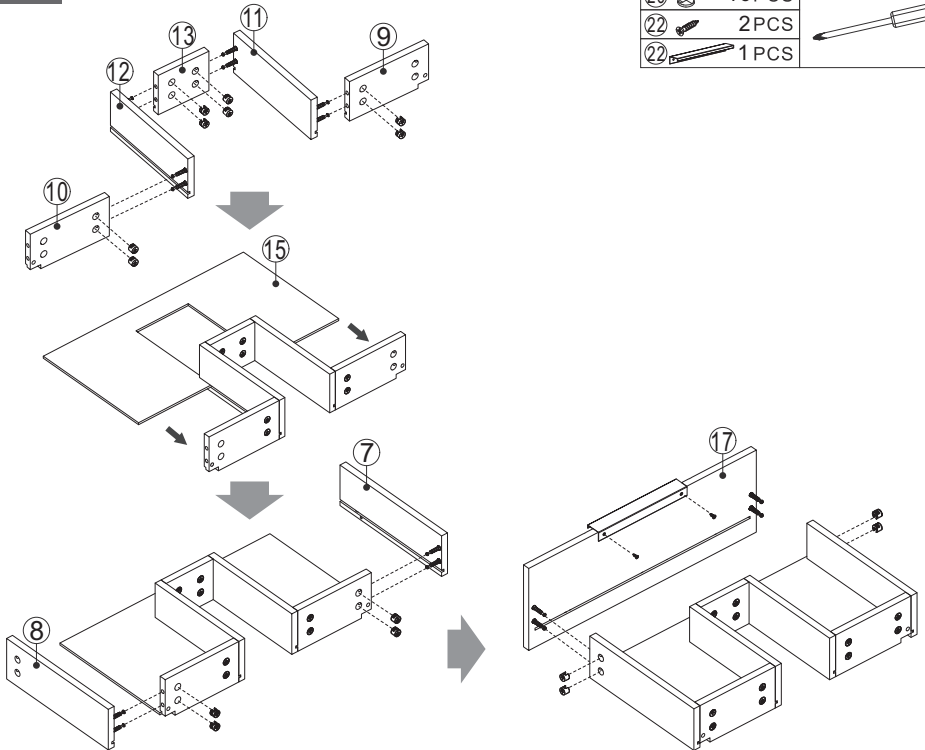
HARDWARE LIST			
20		8 PCS	
22		2 PCS	
22		1 PCS	

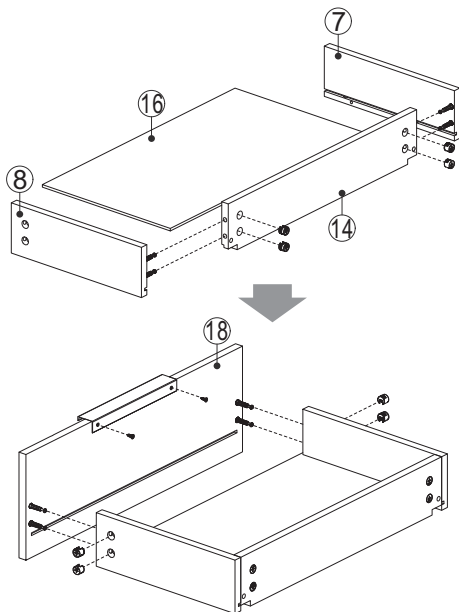

STEP 7

HARDWARE LIST			
24		2 PCS	
24		6 PCS	
24		6 PCS	
26		2 PCS	

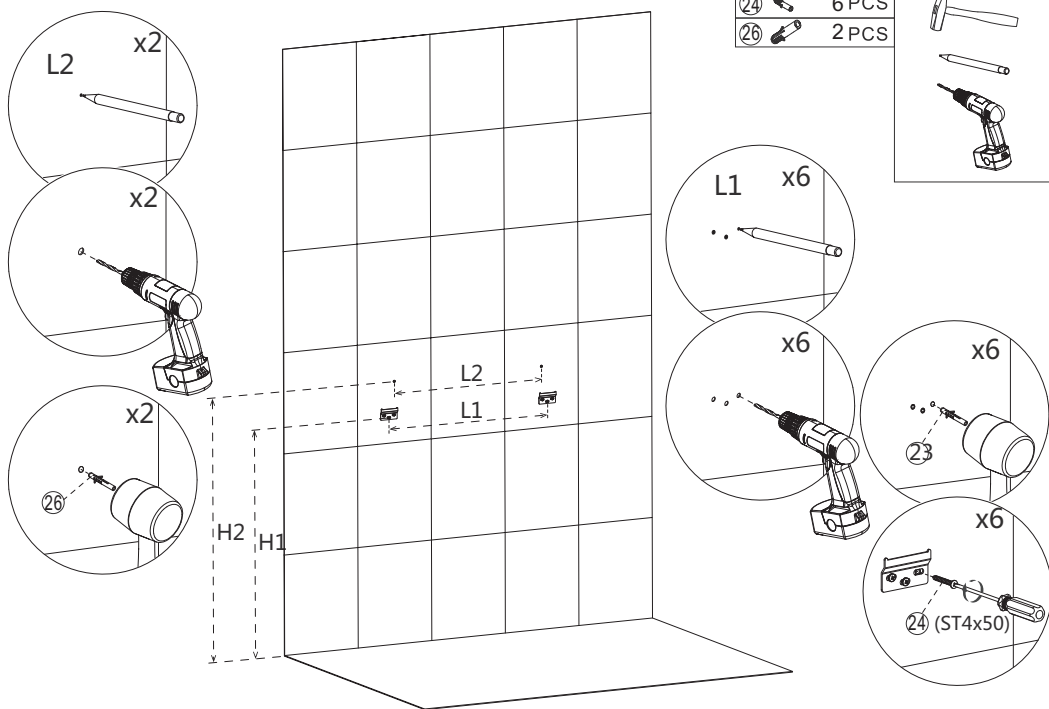

STEP 8

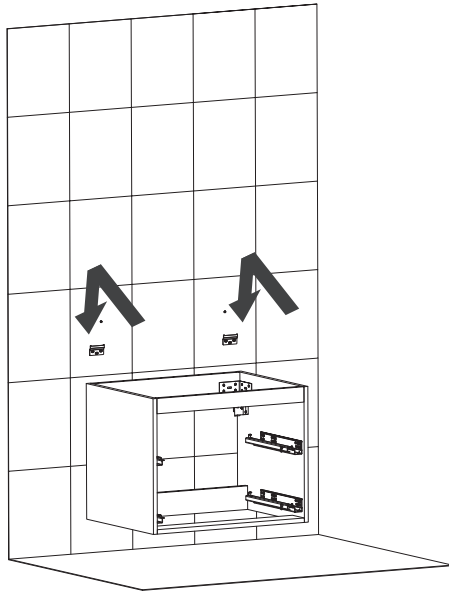

STEP 9

HARDWARE LIST		
26		2PCS
		

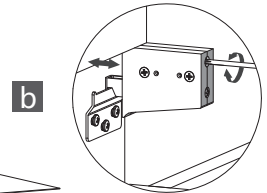
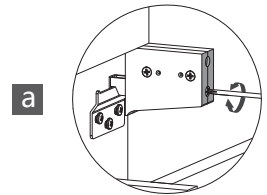
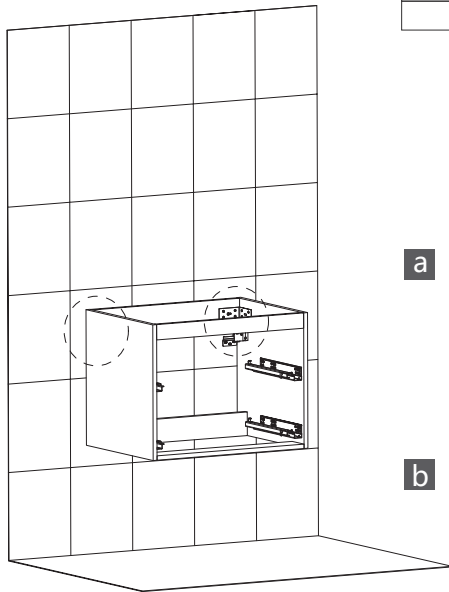
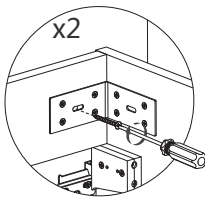

● Through the screw to adjust position of the hange

a up and down

b front and back

STEP 10

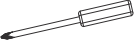
HARDWARE LIST		
20		4 PCS
		

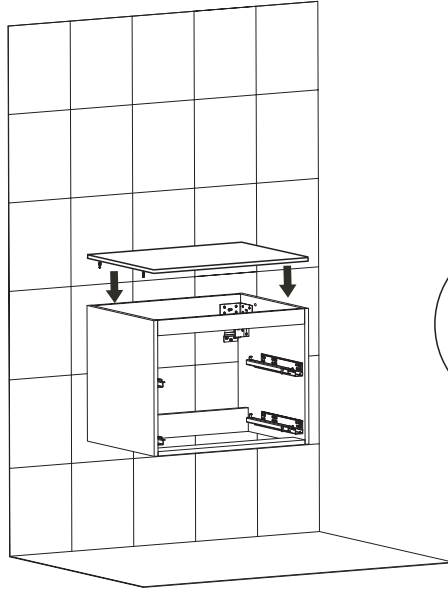

STEP 11

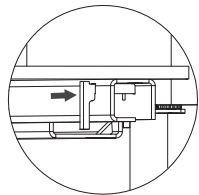
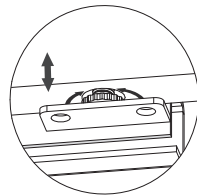
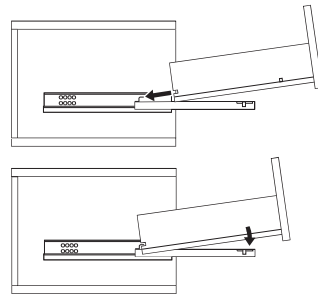
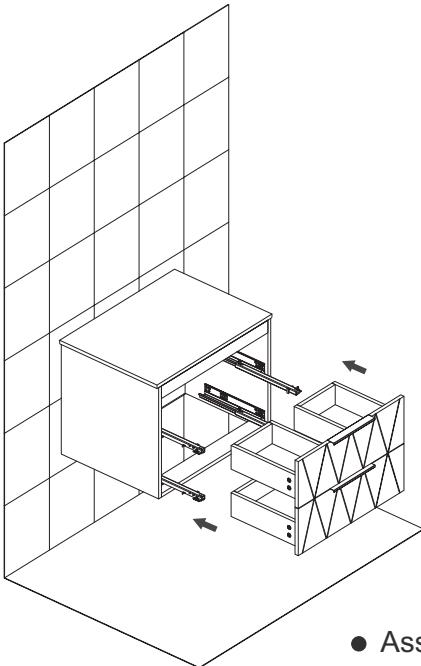

● Assembled drawers are loaded onto cabinets.

CARE AND CLEANING

1. Many cleansers contain abrasive and chemical substance which is not suitable for cleaning stainless steel, enamel, plating or plastic products. You may use mild cleansers or soaps to clean the surfaces. Wipe any splashes of cleaner solutions from the surface with a clean soft cloth.
2. Maintain ventilation in the bathroom and separate the dry area from the damp one if conditions permit. Try to open the door and windows of the bathroom to maintain adequate ventilation.
3. This cabinet is built to withstand normal bathroom humidity. For best results, keep this vanity dry and take necessary steps to minimize bathroom humidity by opening windows and doors and using the exhaust fan (if available).
4. To maintain the cabinet door, clean and wipe the door regularly with a soft cloth. Wipe condensation with a dry, soft cloth. Keep away from high temperatures.
5. Please do not sit, lean or step on the basin cabinet.



Thank you very much for purchasing from us.

We have always been trying to provide the best service and reliable products for every customer.

We sincerely hope you will be satisfied with our products and leave us FIVE STARS and POSITIVE feedback/ review in our page.

However, accident may happen sometimes, please contact us to resolve any issue before leaving a negative feedback.

Many thanks and welcome to our shop again!