

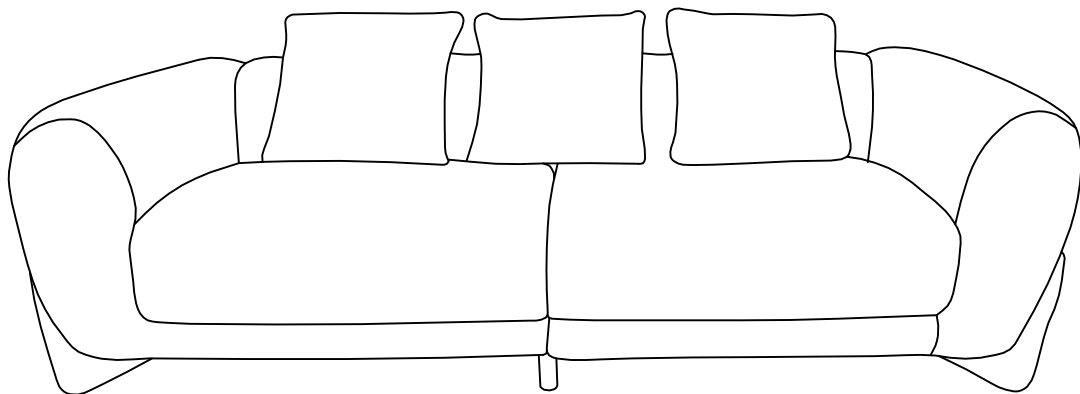

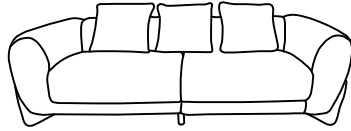







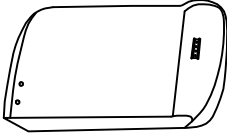

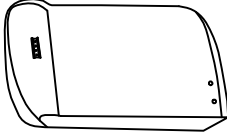
CLOUD SOFA

ASSEMBLY INSTRUCTIONS





ASSEMBLY INSTRUCTIONS





ARM PACKAGE								
ID	PARTS IDENTIFICATION	QTY	ID	HARDWARE PACKING	QTY	ID	HARDWARE PACKING	QTY
A	 LEFT ARM	1 PC	1	 Ø1/4**35mm	2 PCS	8	 Ø5/16" NUT	9 PCS
B	 RIGHT ARM	1 PC	2	 Ø1/4**35mm	9 PCS	9	 Ø5/16"	9 PCS
C	 PILLOW	3 PCS	3	 Ø5/16**60mm	9 PCS	10	 Ø5/16**15mm	9 PCS
			4	 ALLEN KEY	1 PC	11	 ALLEN KEY	1 PC
			5	 Ø5/16**17mm	9 PCS			
			7	 Ø5/16**90mm	9 PCS			

LEFT SEATER PACKAGE

D	 LEFT BACK FRAME	1 PC	F	 LEG	2 PCS
E	 LEFT SEAT	1 PC			

RIGHT SEATER PACKAGE

G	 RIGHT BACK FRAME	1 PC	F	 LEG	2 PCS
H	 RIGHT SEAT	1 PC			

Step 1

Remove the pillows from the bottom of the armrests before assembly.

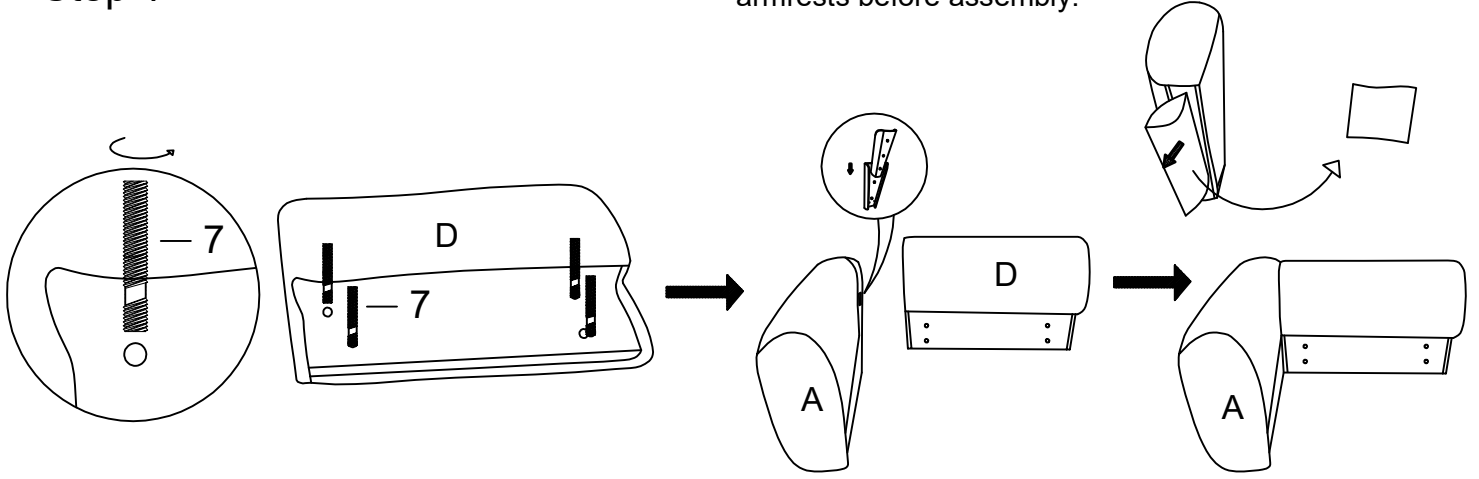

Step 2

Assemble the bench on a soft, scratch-free surface (e.g., a carpet), then tighten the seat back screws with an allen key after the assembly is complete.

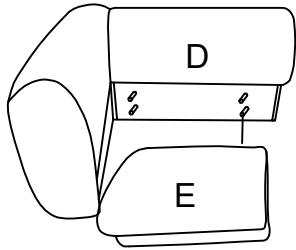

Remove the bolt to ensure the hook can latch onto the bolt on the armrest.

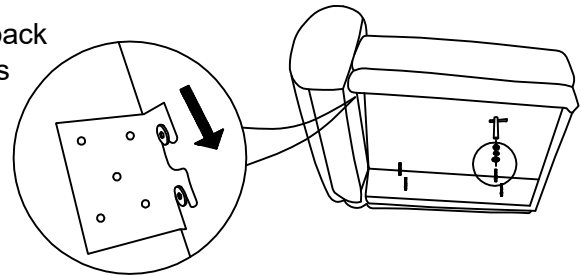

When assembling the screws, fix the two diagonal ones first. This will help align the parts more easily. Fasten the four screws to the seat base using bolts and an Allen key. Partially tighten them first to ensure alignment with the nuts, and then fully tighten.

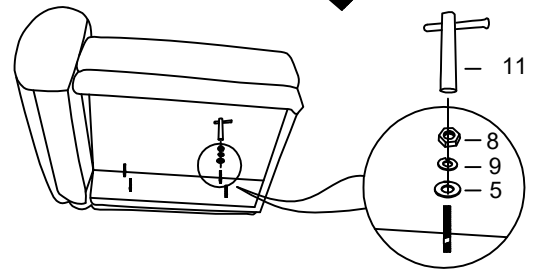

Step 3

Assemble the bench on a soft, scratch-free surface (e.g., a carpet), then tighten the seat back screws with an allen key after the assembly is complete.

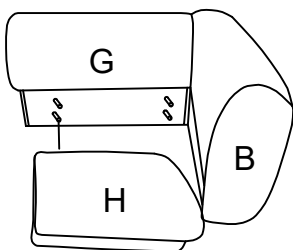

Remove the bolt to ensure the hook can latch onto the bolt on the armrest.

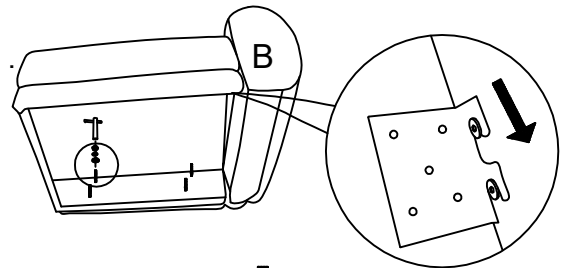

When assembling the screws, fix the two diagonal ones first. This will help align the parts more easily. Fasten the four screws to the seat base using bolts and an Allen key. Partially tighten them first to ensure alignment with the nuts, and then fully tighten.

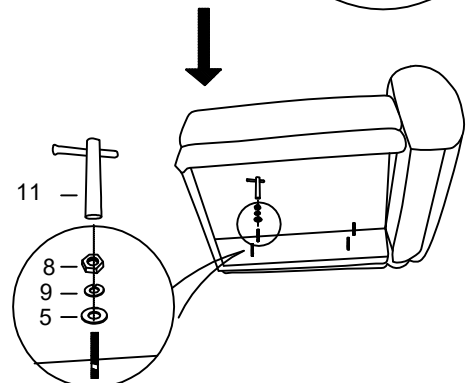

Step 4

Insert the bracket halfway and leave some space. After locating the screw positions, secure the bracket and fully tighten all bolts.

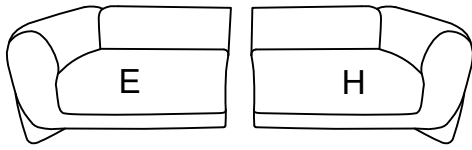

Pre-assemble the center leg bolts, but do not tighten them yet.

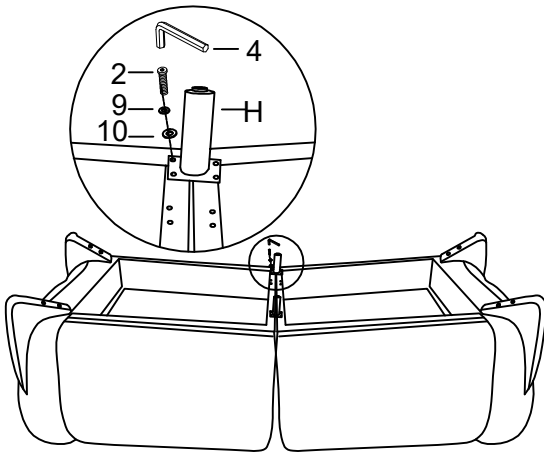
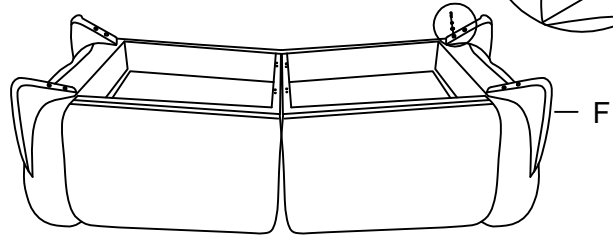
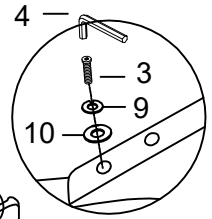

Step 5

Pre-assemble the screws A, but do not tighten yet.

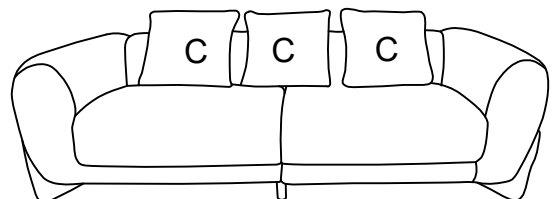
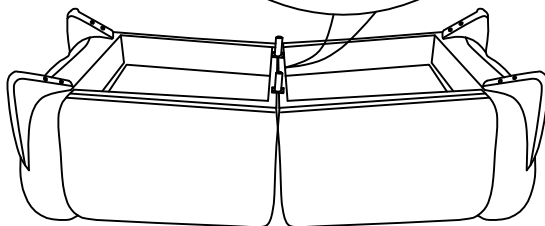
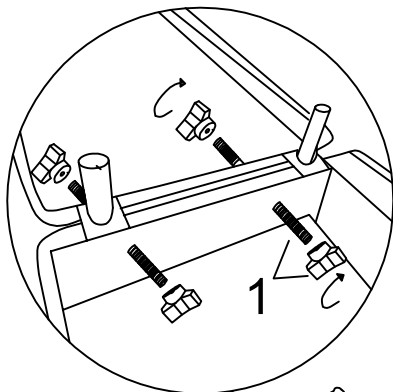

ITEM: CLOUD CHAIR

ASSEMBLY INSTRUCTIONS

ASSEMBLY TIPS

1. Remove hardware from box and sort by size.
2. Please check to see that all hardware and parts present prior to start of assembly.
3. Please follow attached instruction in the same sequence as numbered to assure fast & easy assembly.

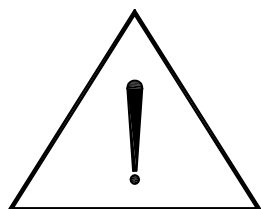

WARNING !

1. Don't attempt to repair or modify parts that are broken or defective. Please contact the store immediately.
2. This product is for home use only and not intended for commercial establishments.

ASSEMBLY TIME : 15-30 MINUTES

