

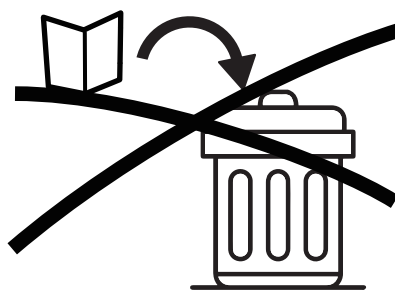

ASSEMBLY INSTRUCTIONS

NOTICE

IMPORTANT, RETAIN FOR FUTURE REFERENCE: READ CAREFULLY
WICHTIG, FÜR SPÄTERE NACHSCHLAGE AUFBEWAHREN: SORGFÄLTIG LESEN
IMPORTANTE, GUARDAR PARA REFERENCIA POSTERIOR: LEER ATENTAMENTE
IMPORTANTE, CONSERVARE PER RIFERIMENTI FUTURI: LEGGERE ATTENTAMENTE
IMPORTANT, À CONSERVER POUR RÉFÉRENCE FUTURE : LIRE ATTENTIVEMENT

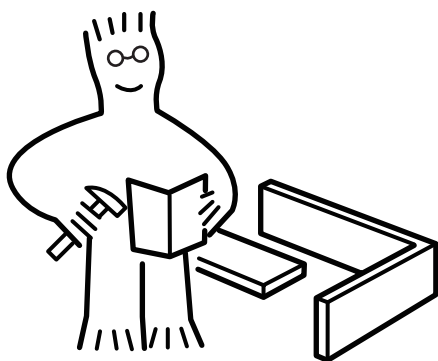

Assemble on a flat, clean and soft surface.
Auf einer flachen, sauberen und weichen Oberfläche zusammenbauen.
Assembler sur une surface plate, propre et douce.
Assemblare su una superficie piatta, pulita e morbida.
Ensamblar sobre una superficie plana, limpia y suave.

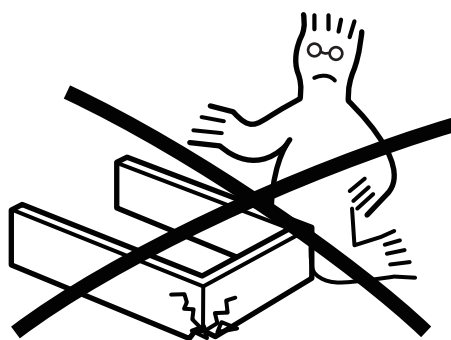
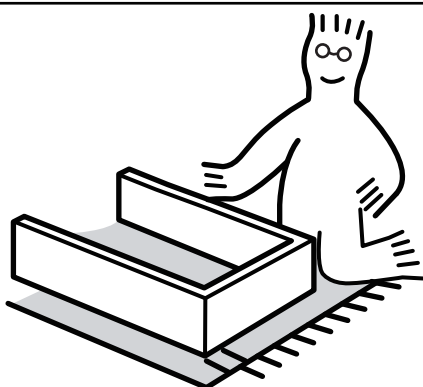

Professional installation is highly recommended.
Eine professionelle Installation wird dringend empfohlen.
Une installation professionnelle est fortement recommandée.
Si raccomanda vivamente l'installazione professionale.
Se recomienda altamente la instalación profesional.



Periodically Check That All Components Are Tightly Secured.
Überprüfen Sie Regelmäßig, Dass Alle Komponenten Fest Gesichert Sind.
Vérifiez Périodiquement Que Tous Les Composants Sont Bien Fixés.
Controllare Periodicamente Che Tutti I Componenti Siano Ben Fissati.
Verifique Periódicamente Que Todos Los Componentes Estén Bien Asegurados.

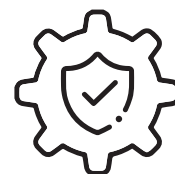

It is recommended that multiple people assemble this product.

Es wird empfohlen, dass mehrere Personen dieses Produkt zusammenbauen.







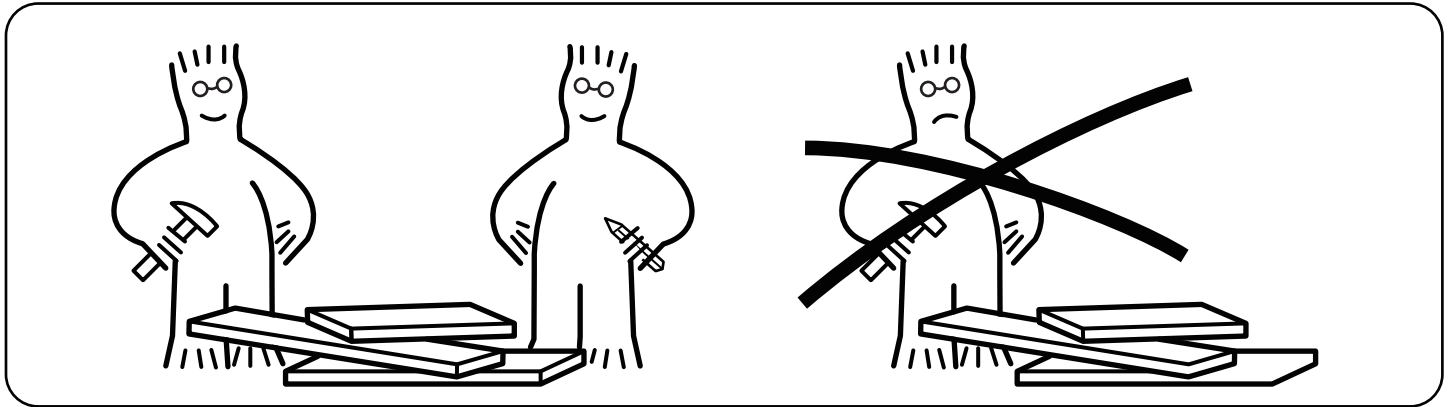



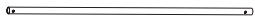







Il est recommandé que plusieurs personnes assemblent ce produit.







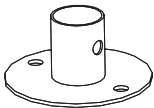
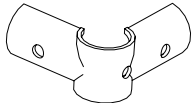
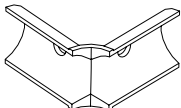
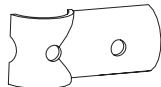

Si raccomanda che più persone assemblino questo prodotto.

Se recomienda que varias personas ensamblen este producto.

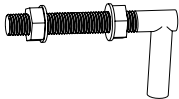
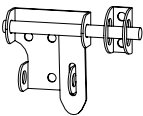
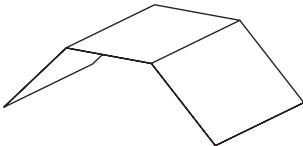
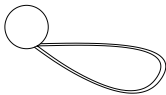

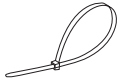
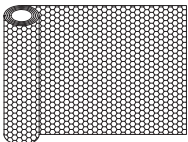
PARTS

Item no. Nr. N° d'article Articolo No. Artículo No.	Reference Image Referenzbild Image de référence Immagine di riferimento Imagen de referencia	Qty. Menge Qté. Qtà Cant.	Item no. Nr. N° d'article Articolo No. Artículo No.	Reference Image Referenzbild Image de référence Immagine di riferimento Imagen de referencia	Qty. Menge Qté. Qtà Cant.
1	 L:990mm	X12	2	 L:990mm	X12
3	 L:1497mm	X1	4	 L:1497mm	X1
5	 L:1497mm	X1	6	 L:1497mm	X1
7	 L:1158mm	X8	8	 L:1158mm	X8
9	 L:1005mm	X4	10	 L:1005mm	X6
11	 L:1005mm	X6	12	 L:907mm	X1
13	 L:987mm	X1	14	 L:907mm	X1
15	 L:987mm	X1	16	 L:500mm	X4
17	 L:900mm	X2	18	 L:900mm	X2

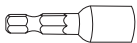
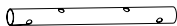



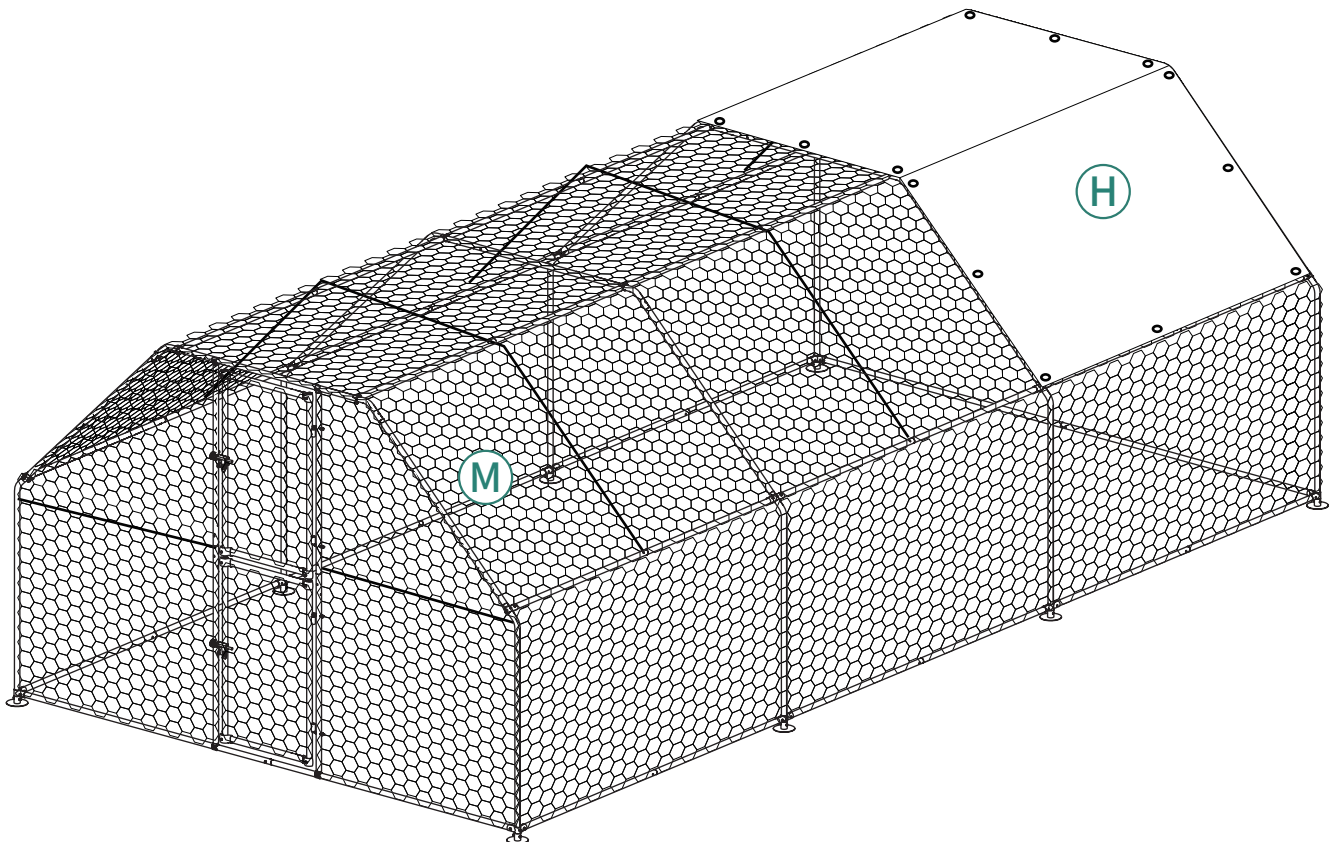
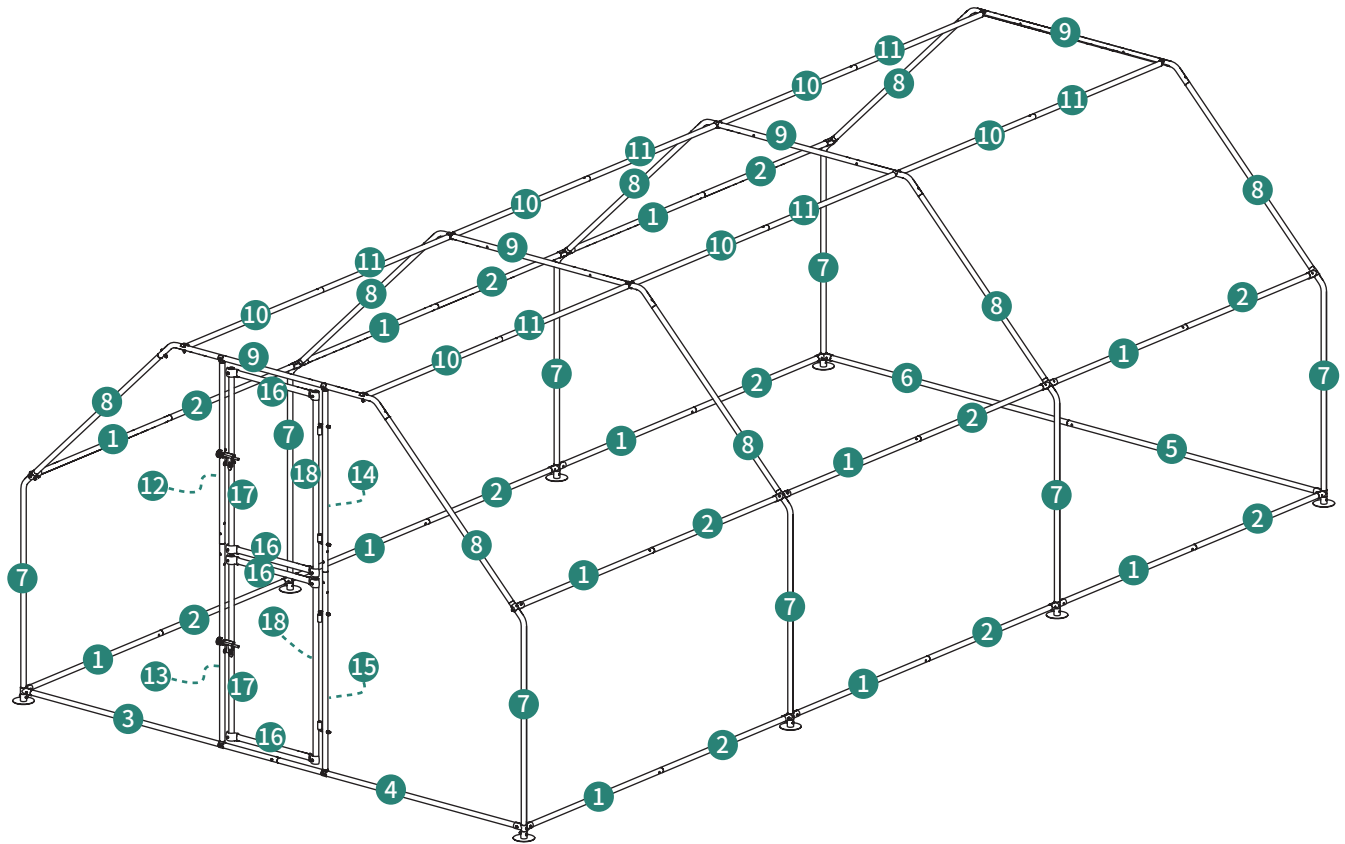



Item no. Nr. N° d'article Articolo No. Artículo No.	Reference Image Referenzbild Image de référence Immagine di riferimento Imagen de referencia	Qty. Menge Qté. Qtà Cant.	Item no. Nr. N° d'article Articolo No. Artículo No.	Reference Image Referenzbild Image de référence Immagine di riferimento Imagen de referencia	Qty. Menge Qté. Qtà Cant.
A		X8	B		X4
C		X4	D		X8
E		X16	F		X4
G		X2	H		X1
J		X20	K	 M6X40mm	X116
L		X52	M		X1
N		X1	P		X1
Q		X2	R		X8
S		X1	T		X2

EXPLODED VIEW

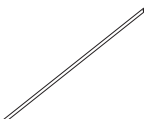
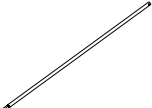

ASSEMBLY

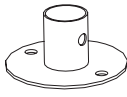
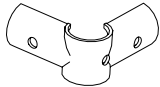
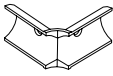
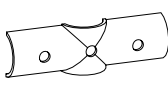
1

- | | | | | | | |
|---|---|---|---|---|---|---|
| L:990mm | L:990mm | L:1497mm | L:1497mm | L:1497mm | L:1497mm | L:1497mm |
|  |  |  |  |  |  |  |
| ①6pcs | ②6pcs | ③1pc | ④1pc | ⑤1pc | ⑥1pc | ⑦8pcs |
|  |  |  |  |  | | |
| Ⓐ8pcs | Ⓑ4pcs | Ⓒ4pcs | Ⓔ8pcs | Ⓚ40pcs | | |

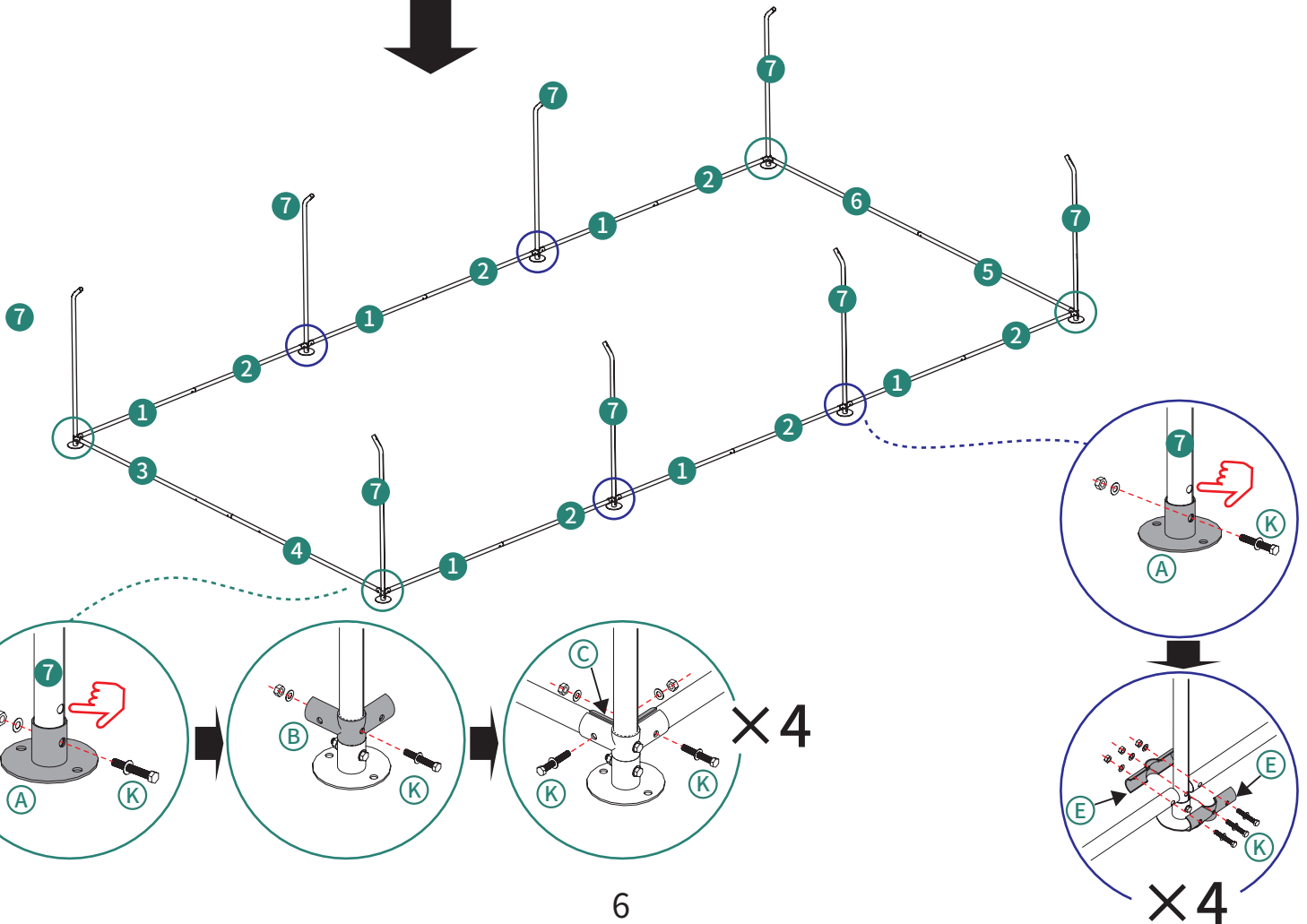
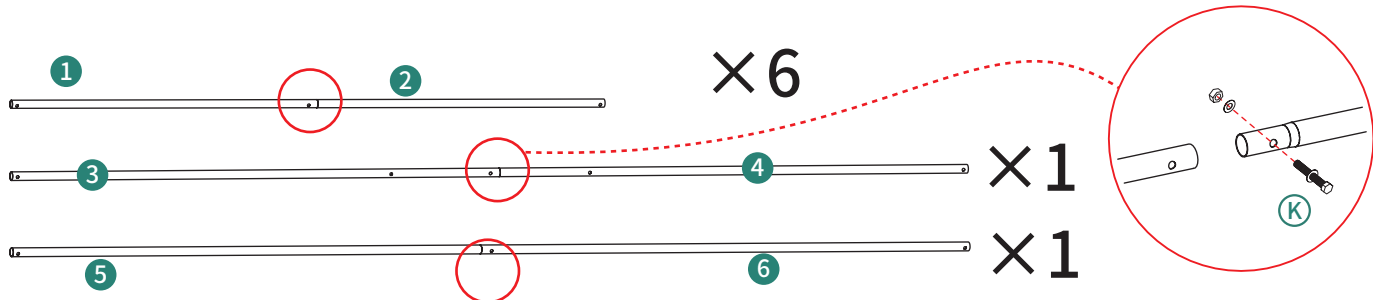

2

L:1158mm

⑧ 8pcs

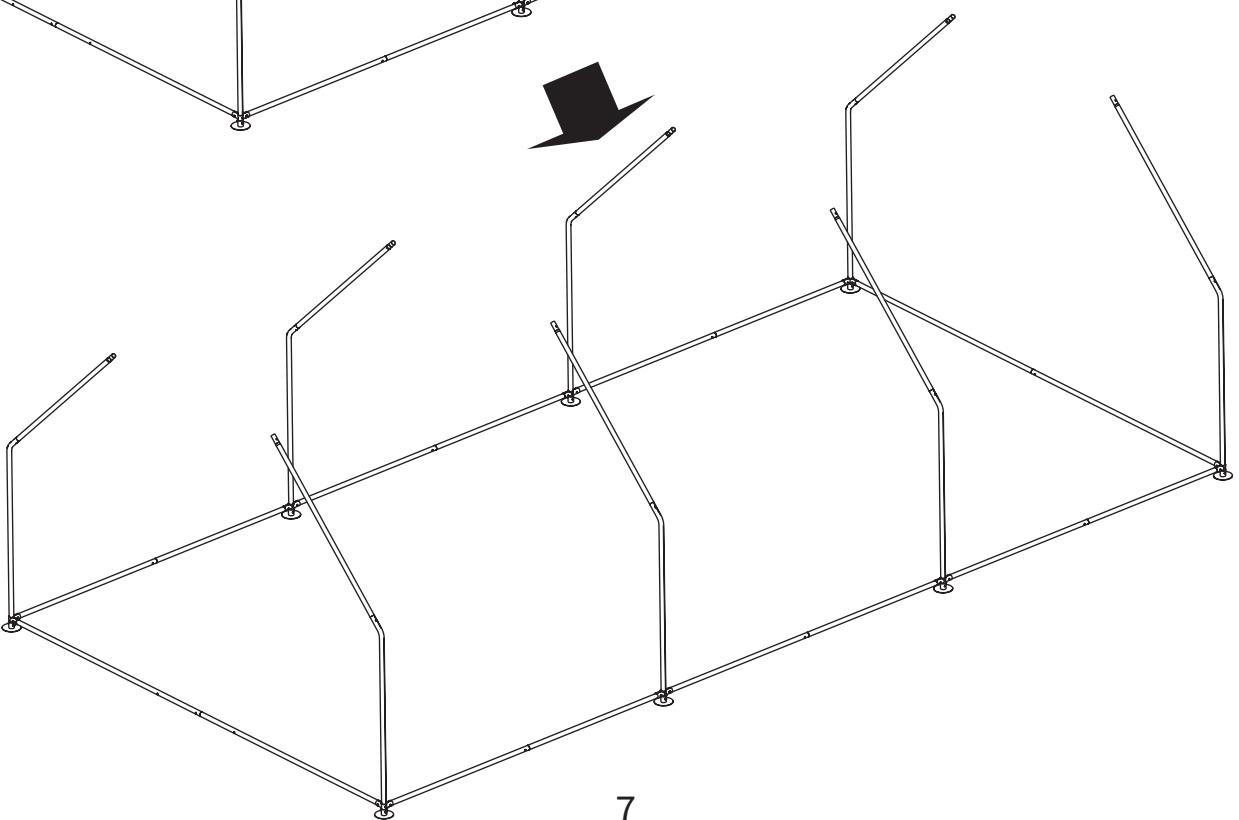
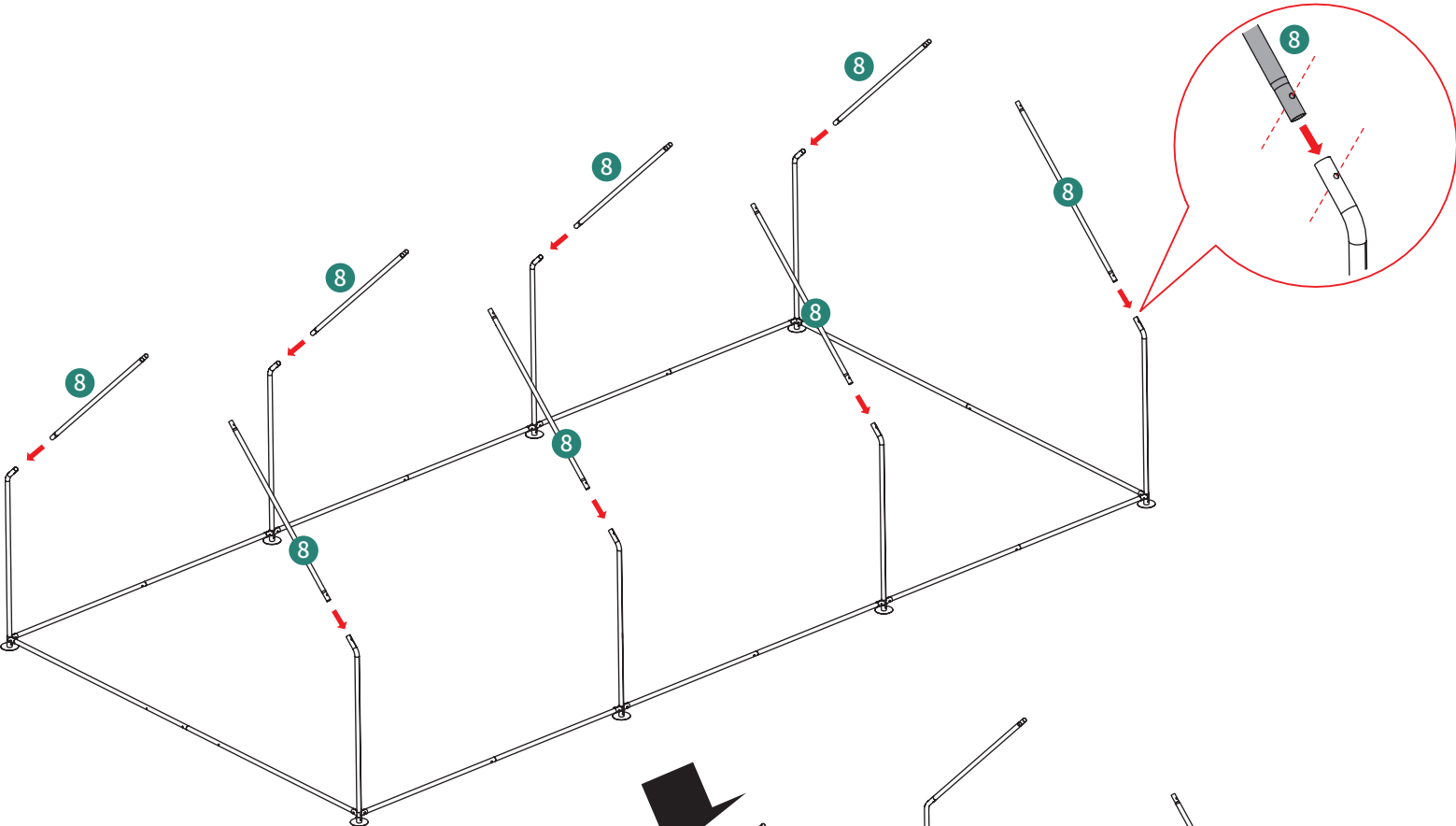

3

L:990mm

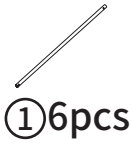

①6pcs

L:990mm

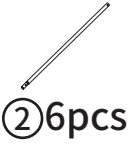

②6pcs

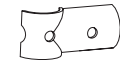

④8pcs

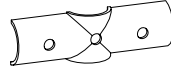

⑤8pcs

M6X40mm



⑥26pcs

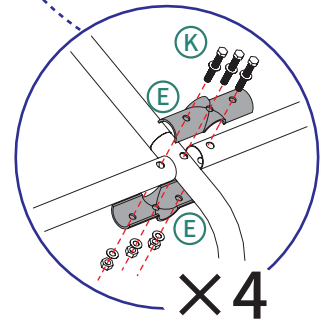
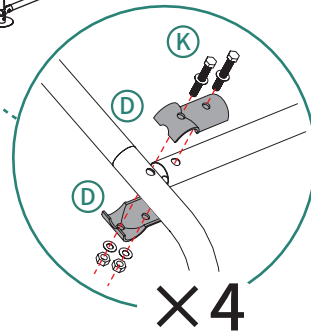
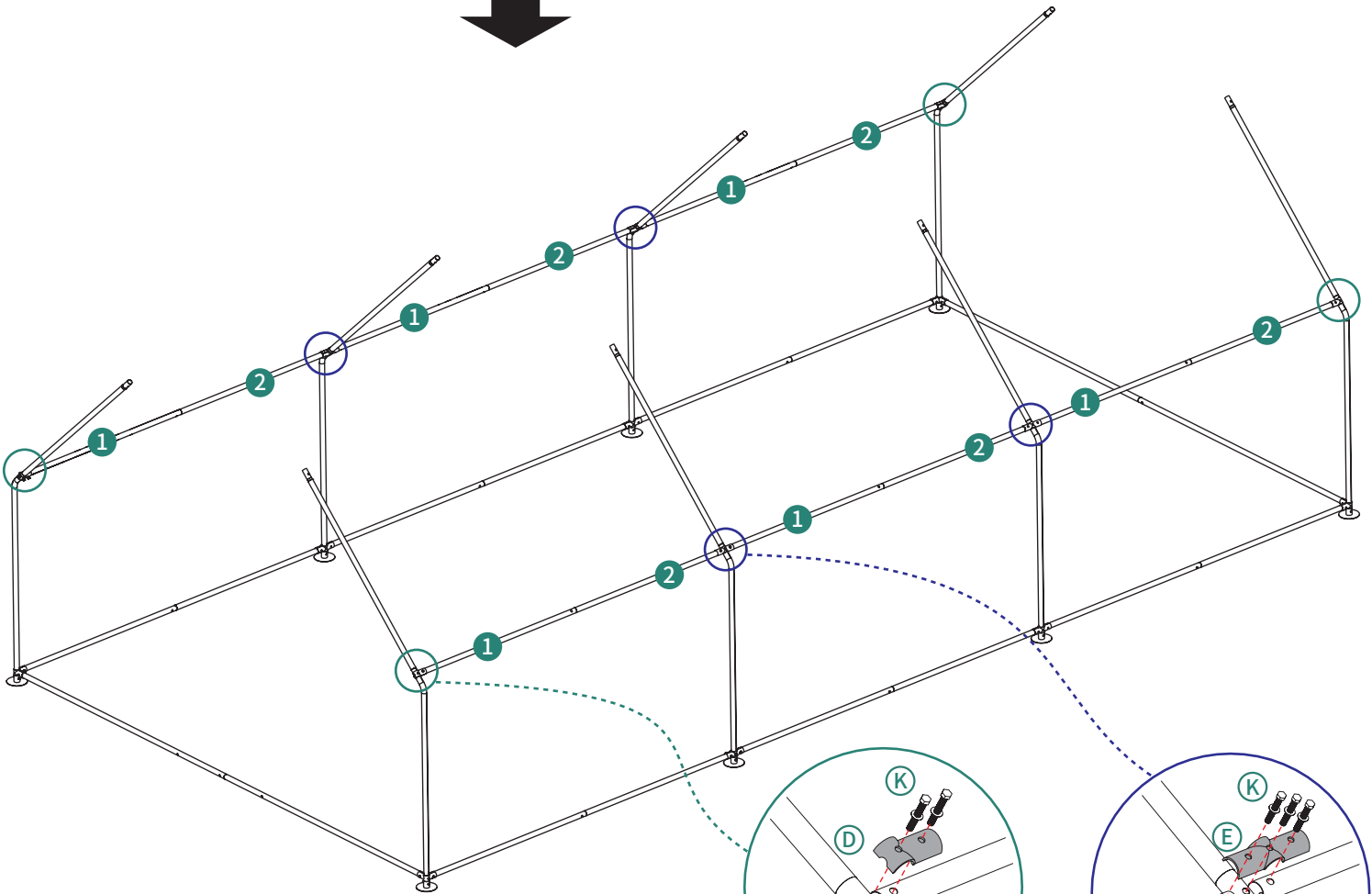
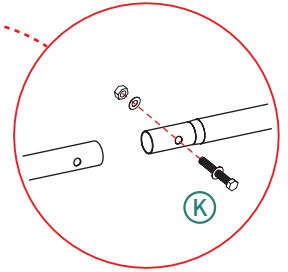

4

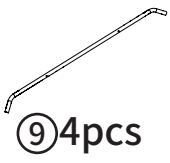

M6X40mm

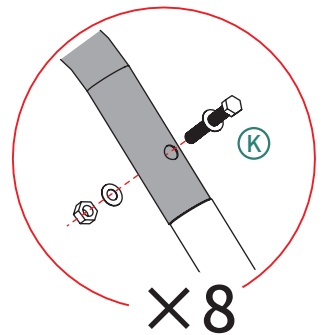
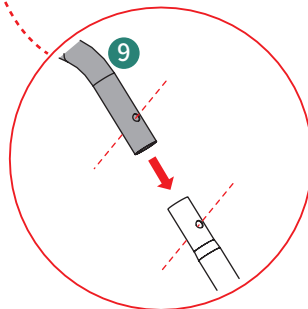
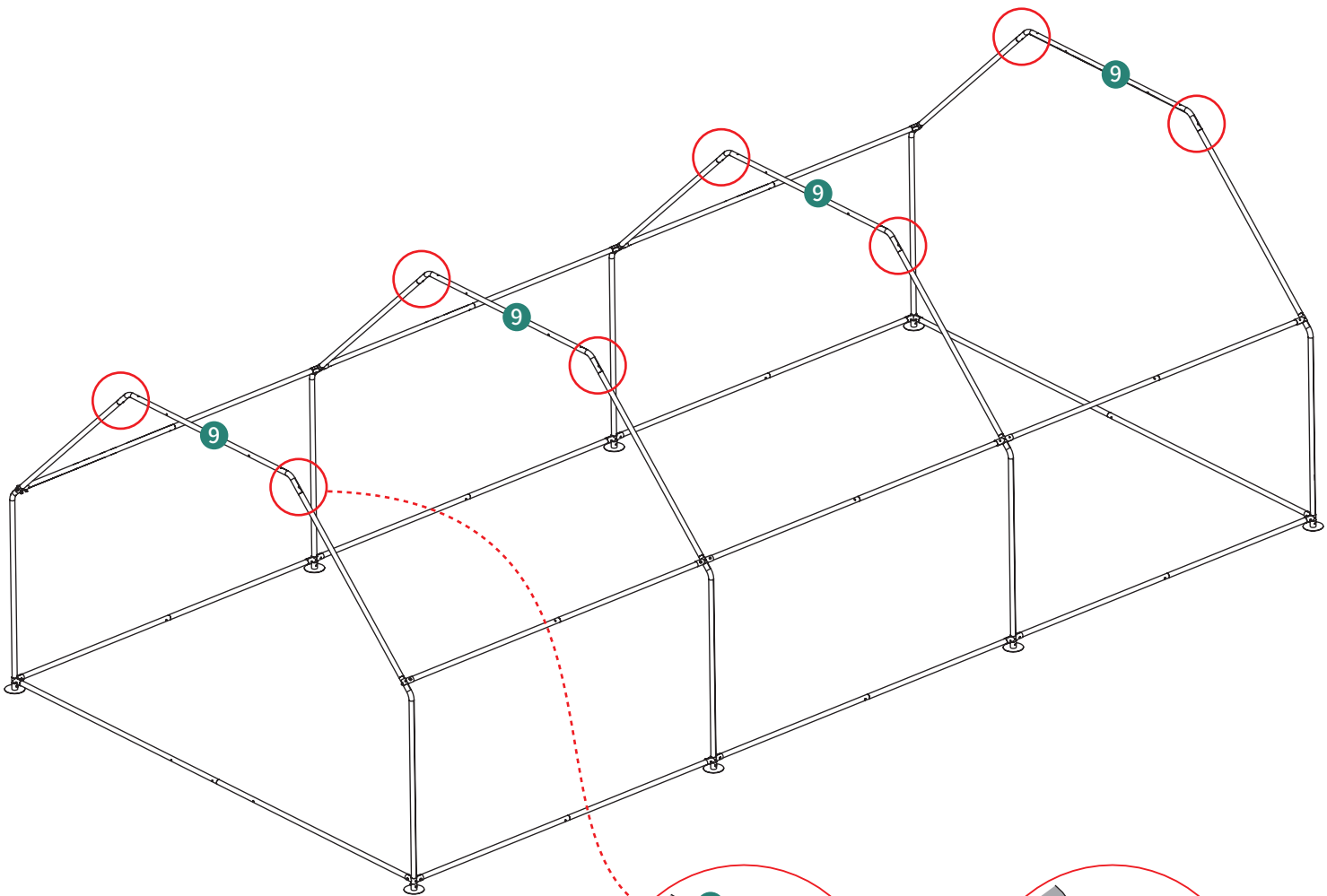

9

5

L:1005mm

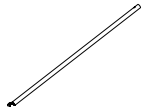

⑩6pcs

L:1005mm



⑪6pcs

M6X40mm



Ⓚ14pcs

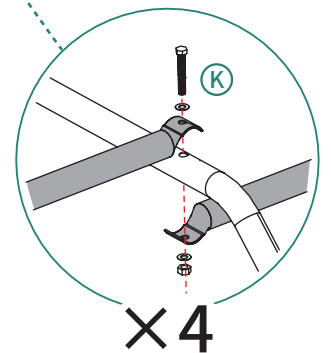
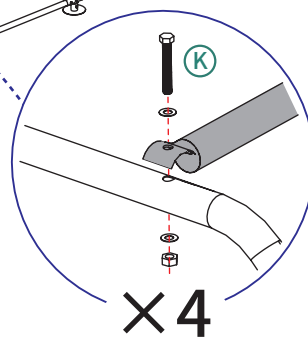
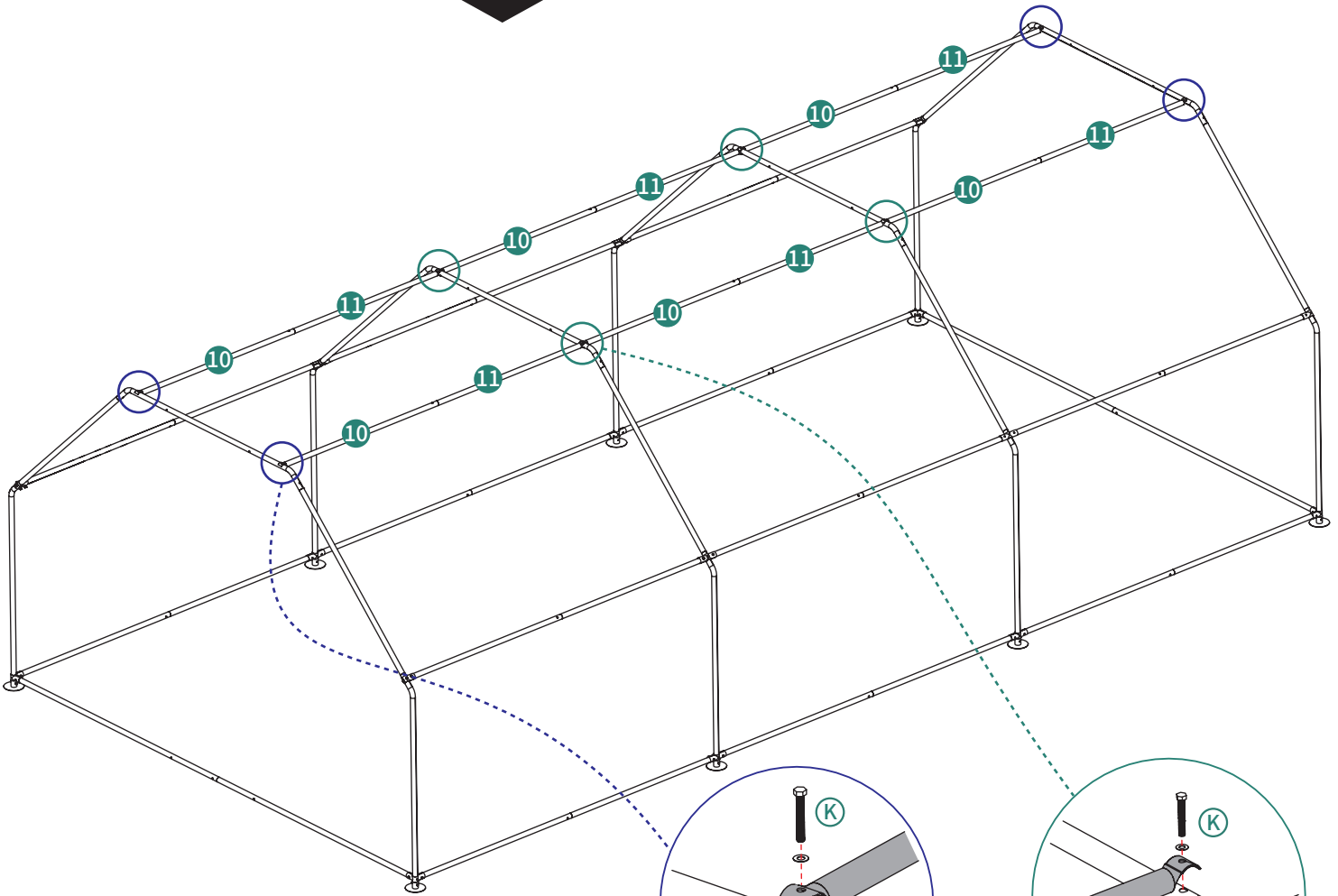
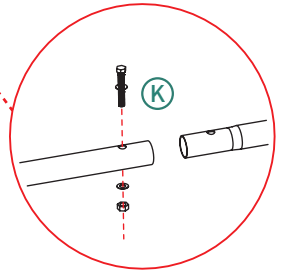
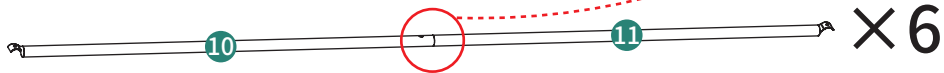

10

6

L:907mm

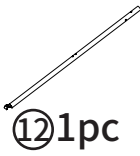

⑫1pc

L:987mm

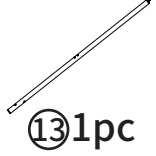

⑬1pc

L:907mm

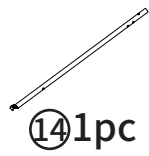

⑭1pc

L:987mm

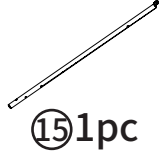

⑮1pc

M6X40mm



Ⓚ12pcs

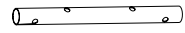

Ⓣ2pcs

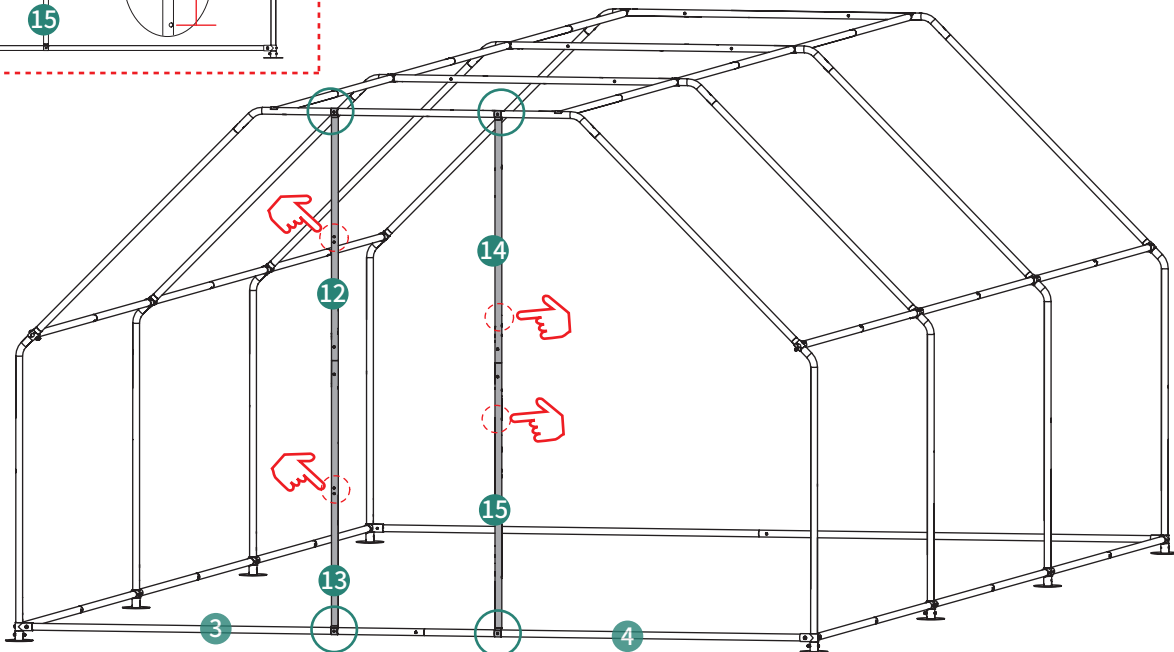
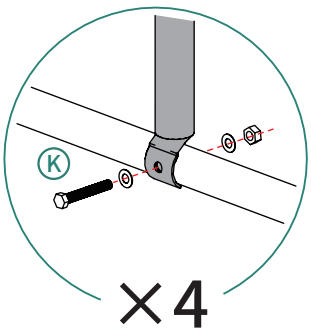
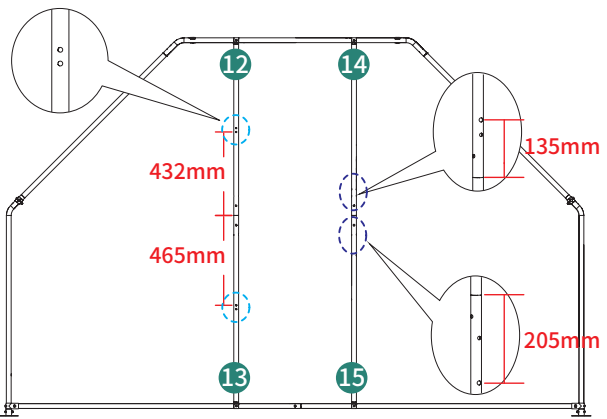
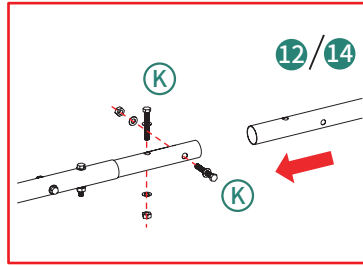
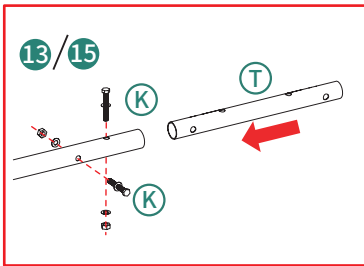
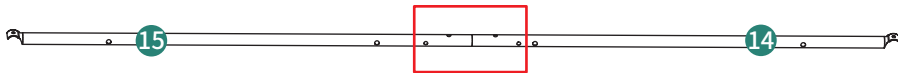
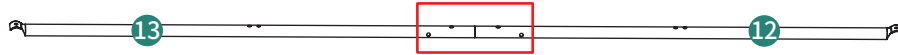

7

 **L** 18pcs

 **M** 1pc

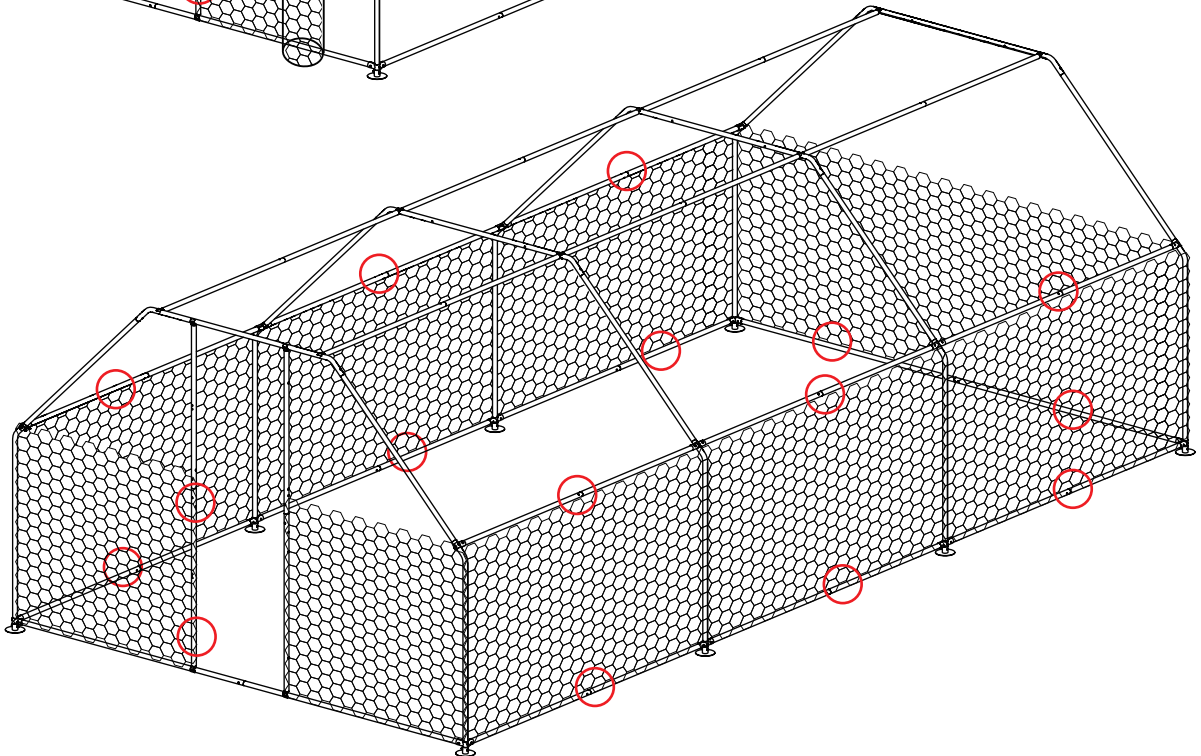
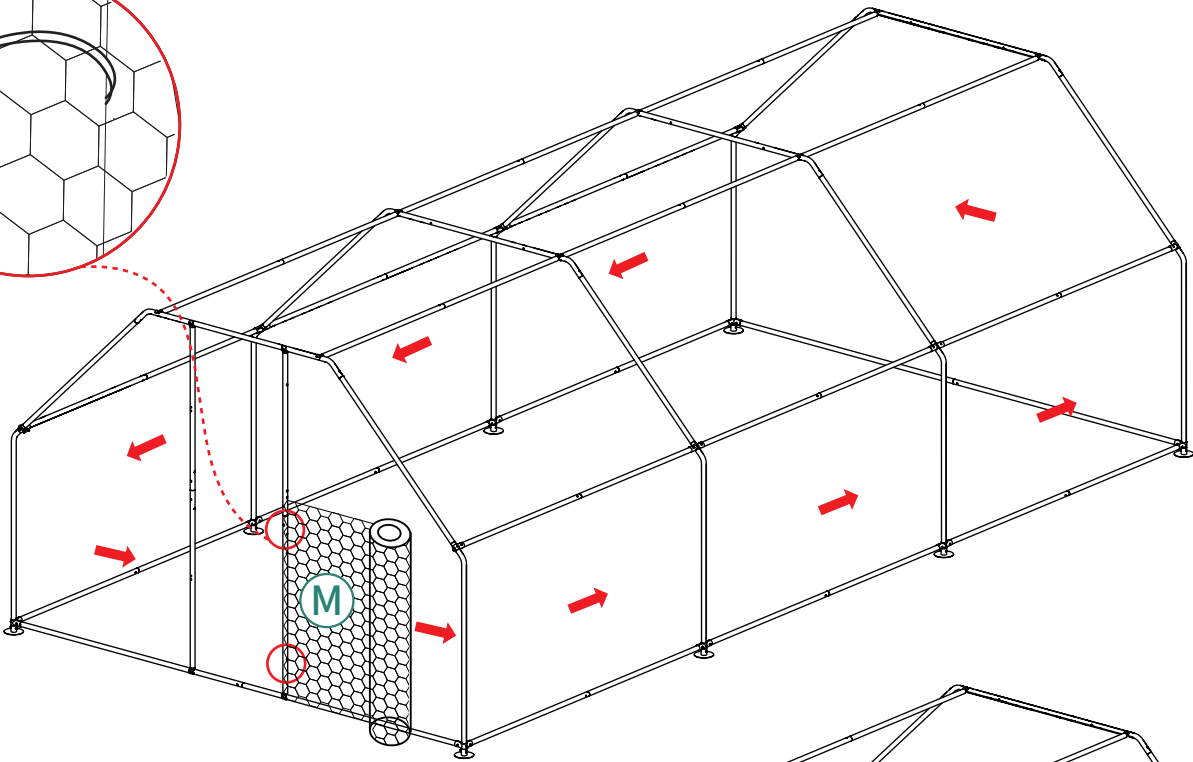
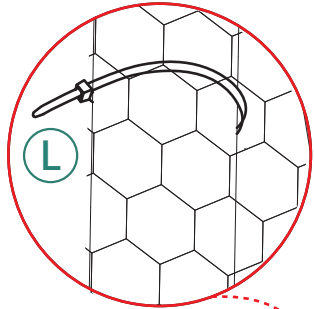

8

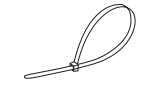

(L) 16pcs

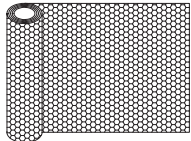

(M) 1pc



(N) 1pc

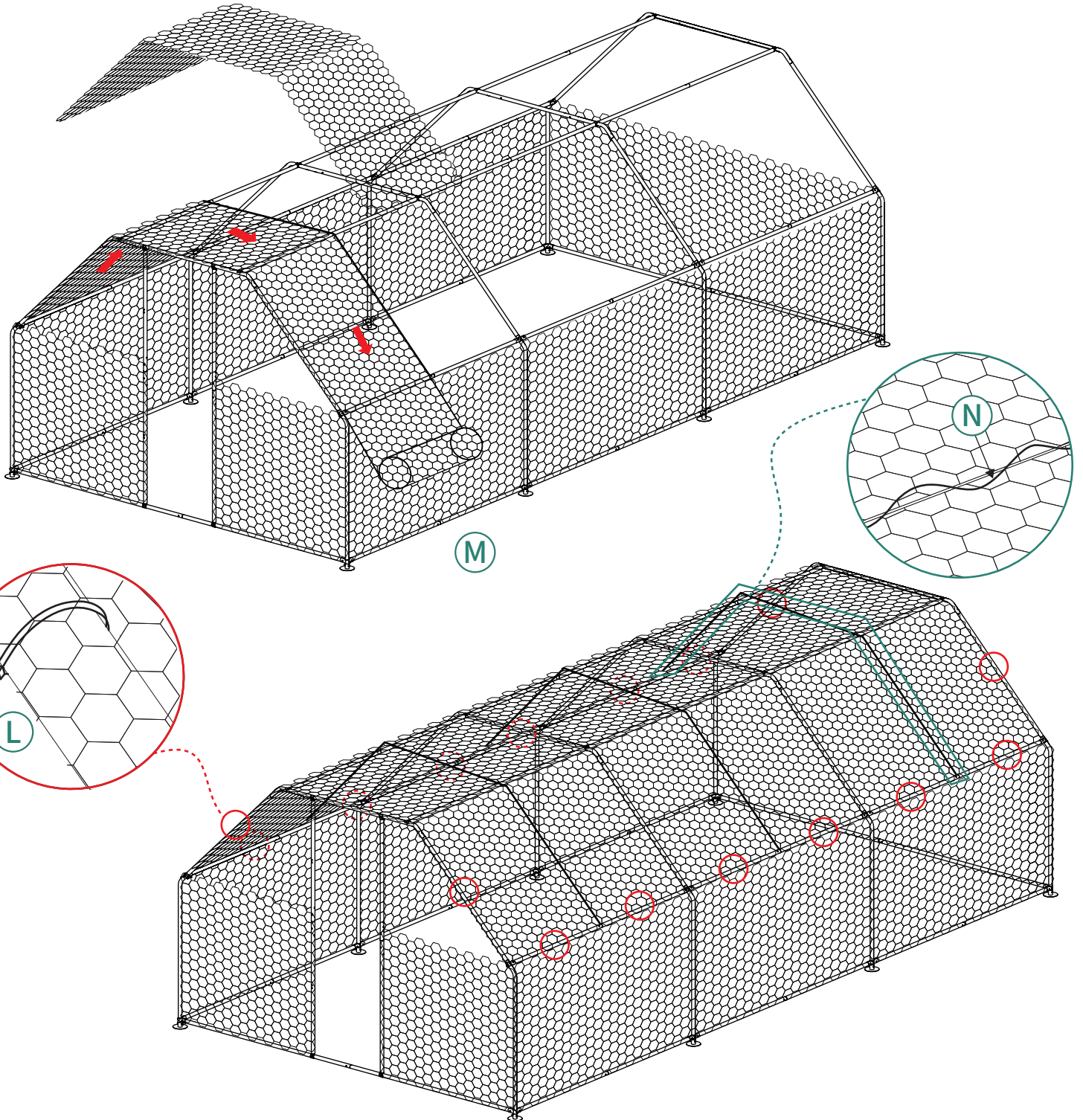

9

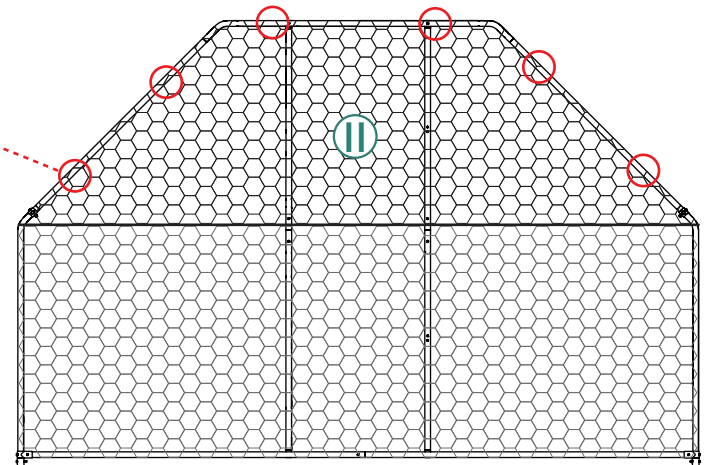
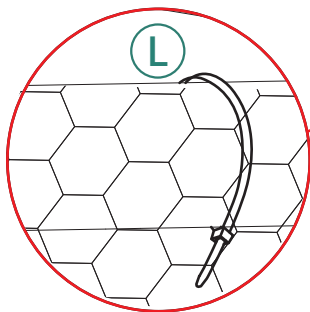
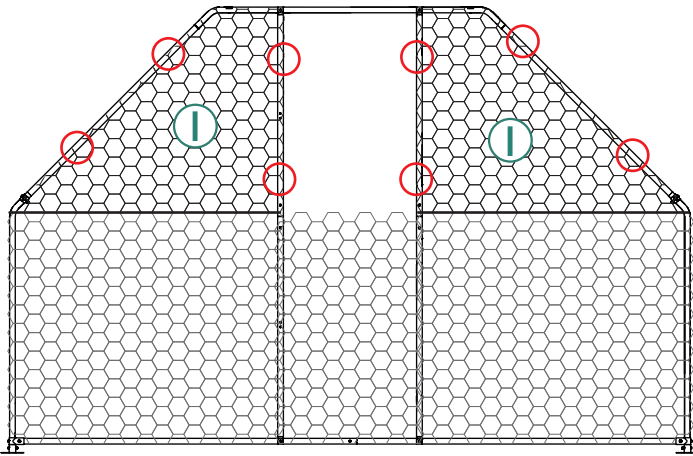
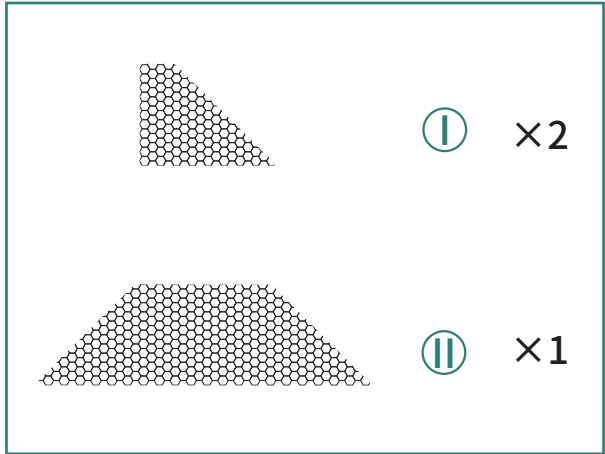
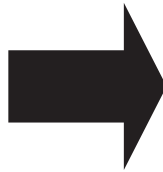
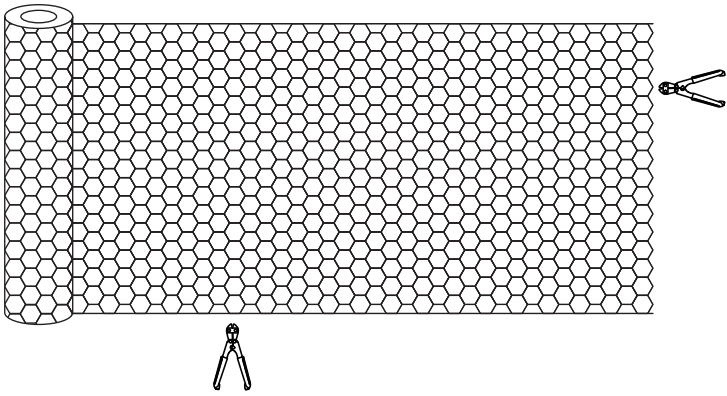
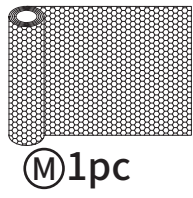

10 
Ⓝ1pc

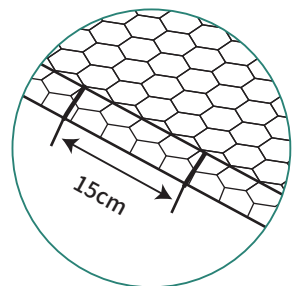
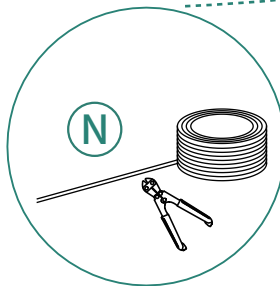
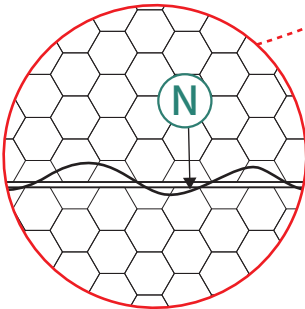
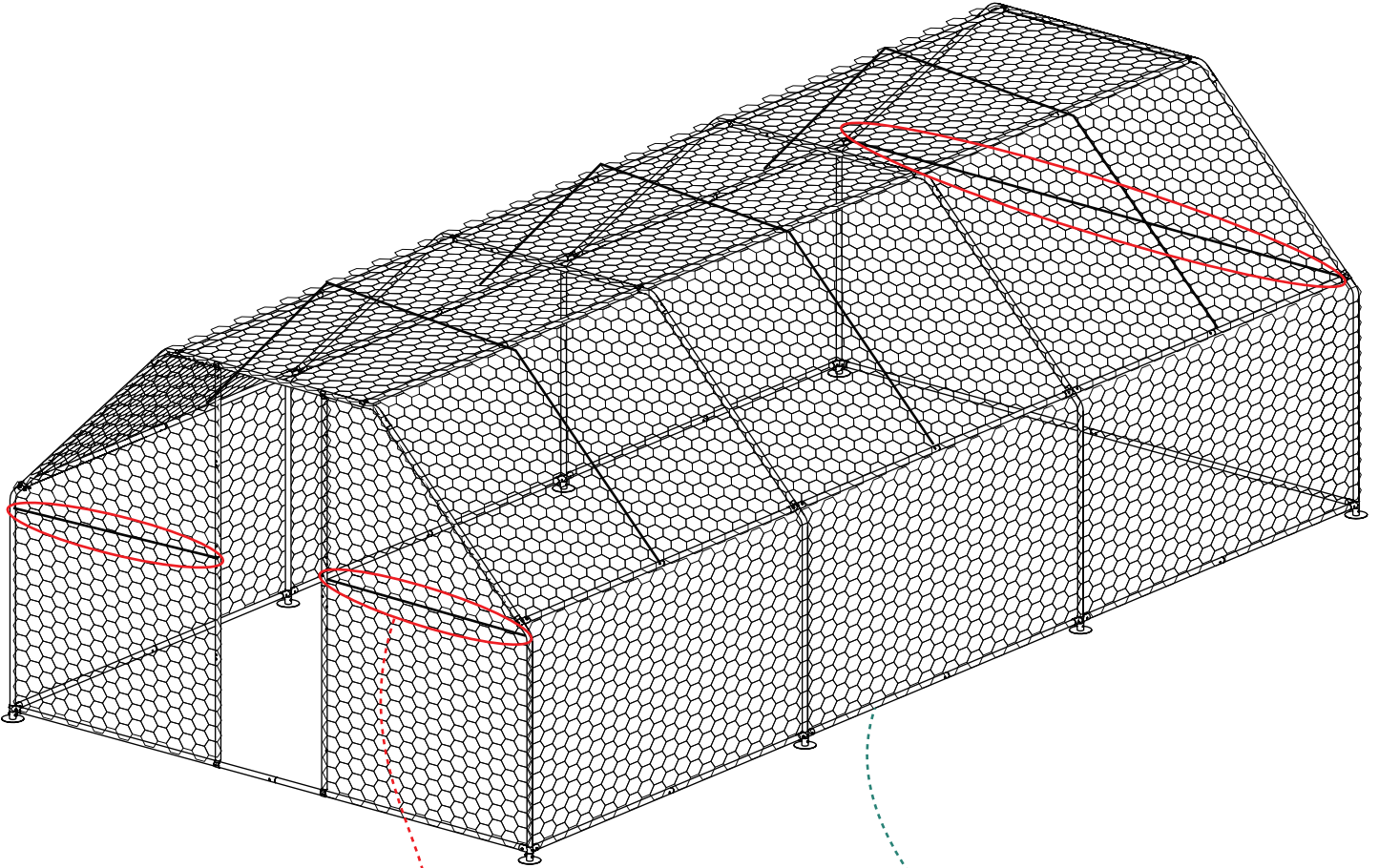

11

L:500mm



⑩4pcs

L:900mm

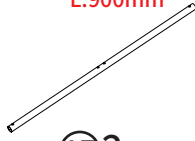

⑪2pcs

L:900mm



⑫2pcs

M6X40mm



Ⓚ8pcs

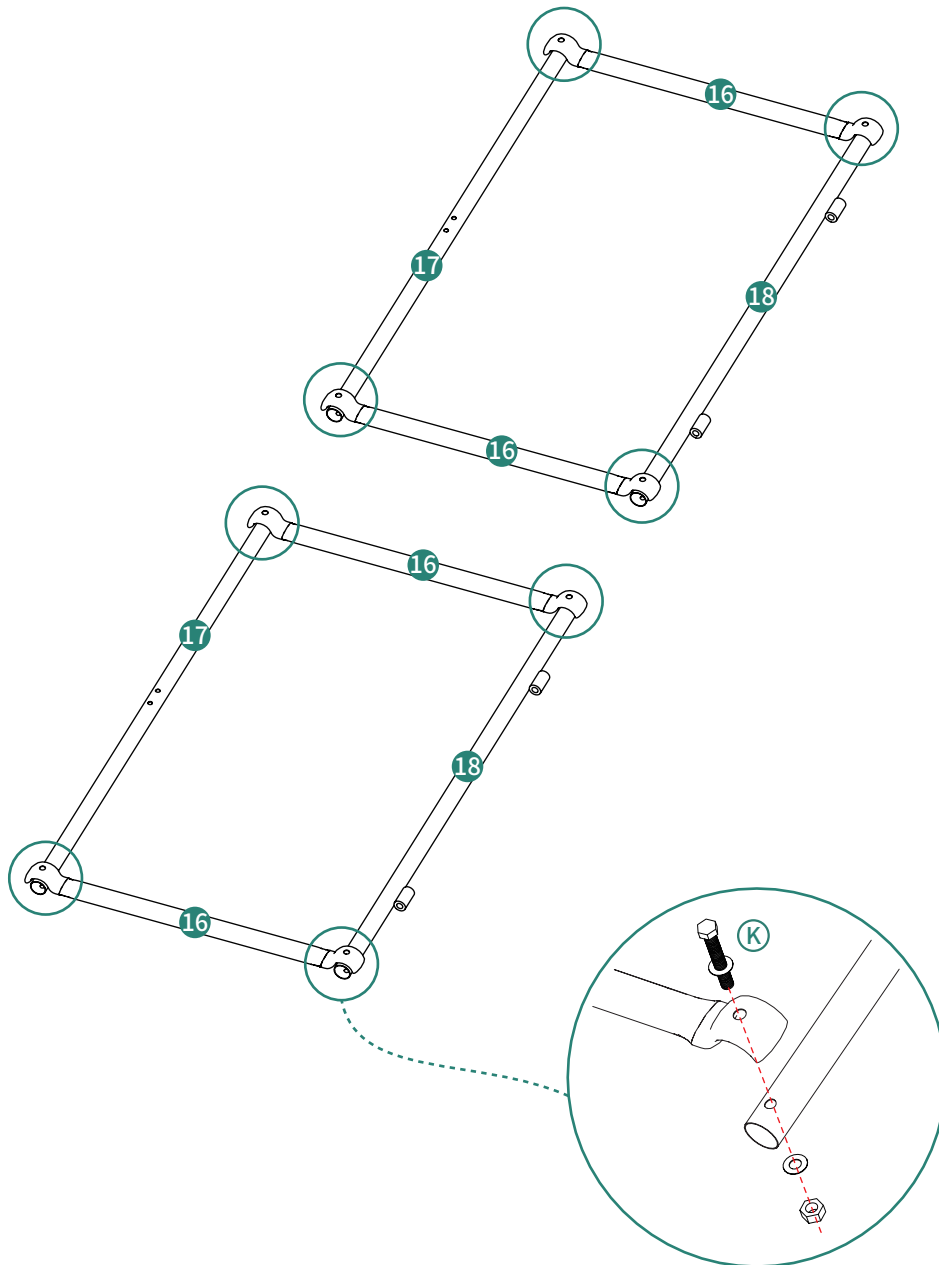

12

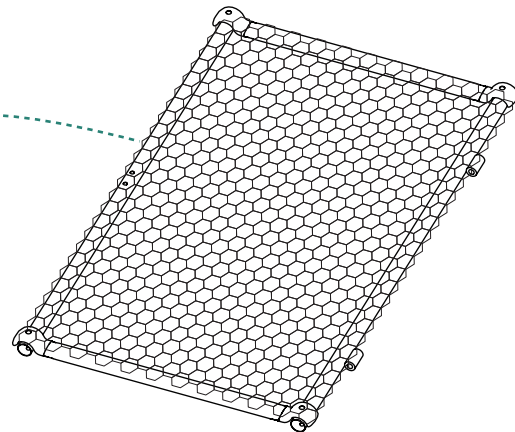
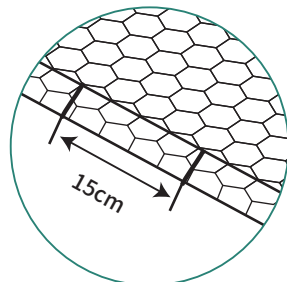
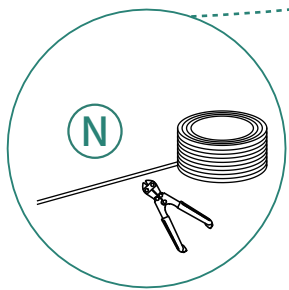
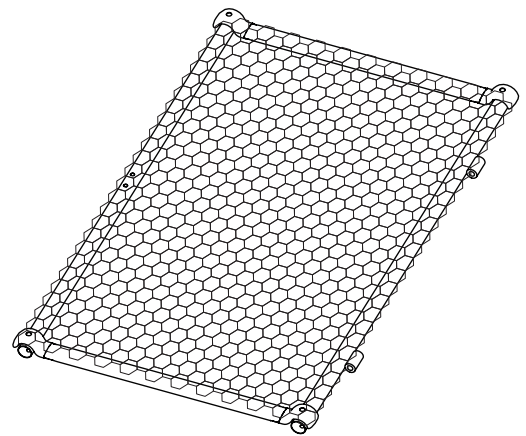
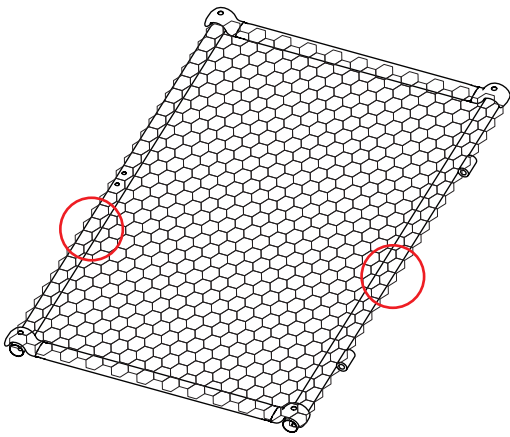
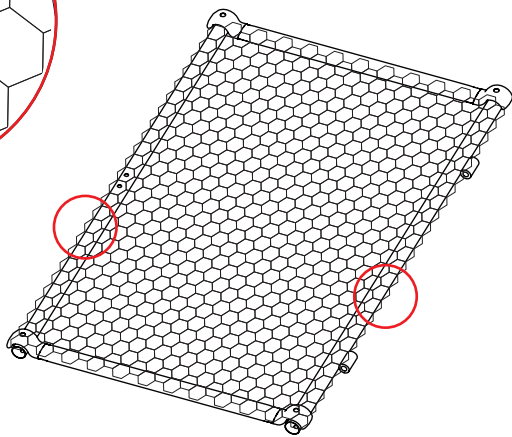
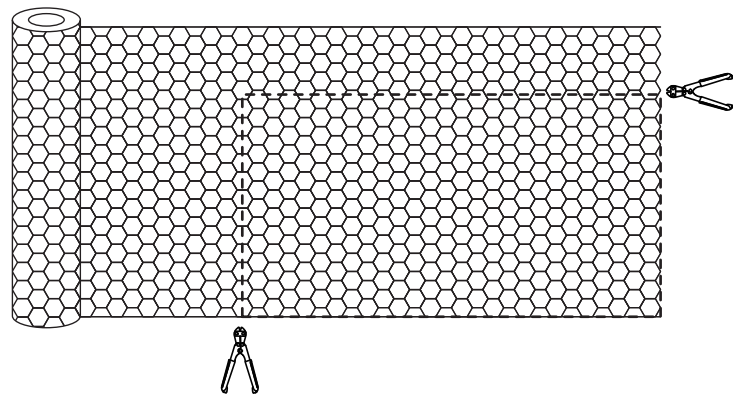
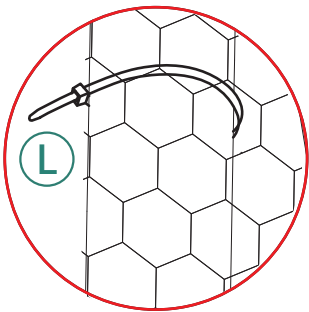
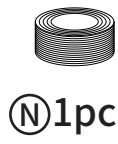
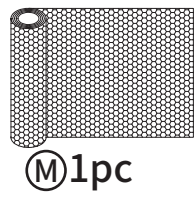

13

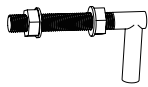

ⓕ 4pcs

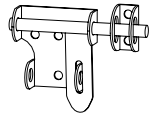

ⓖ 2pcs

M6X40mm



Ⓚ 8pcs

2

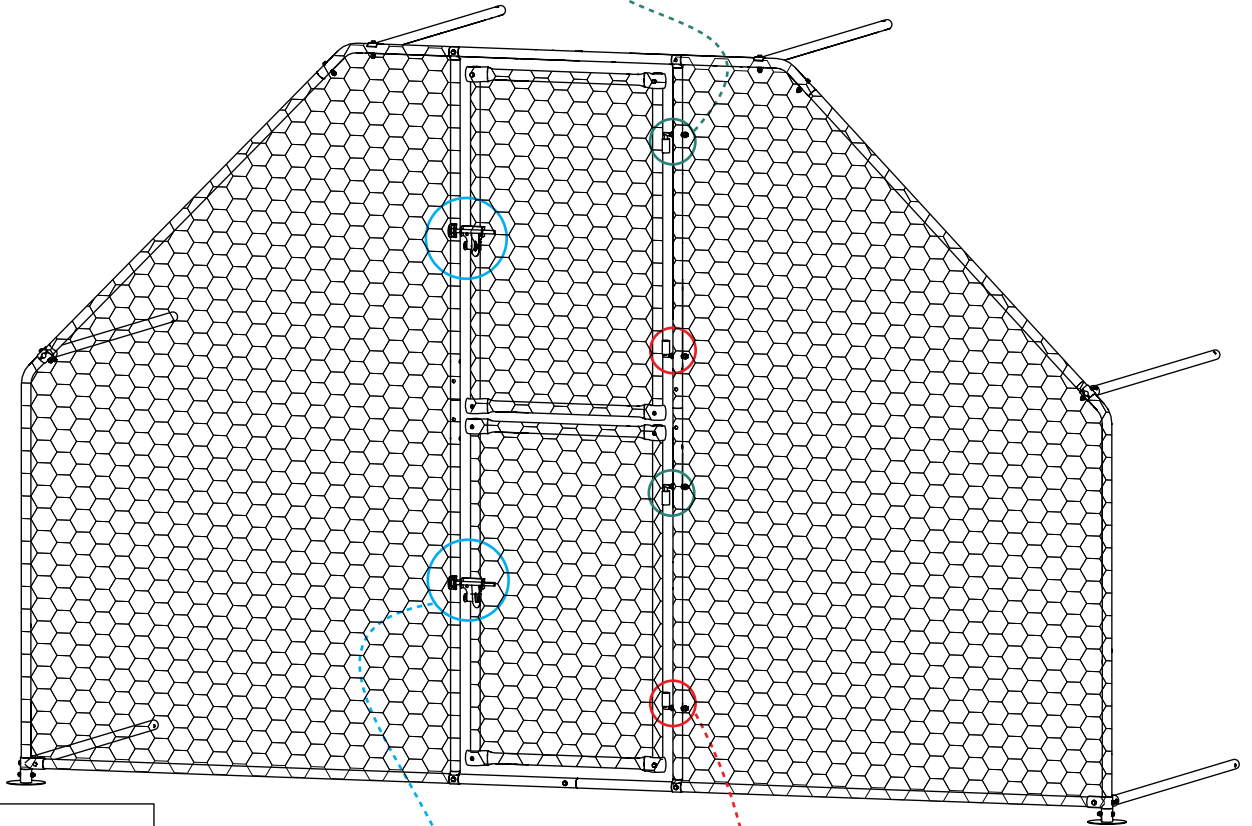
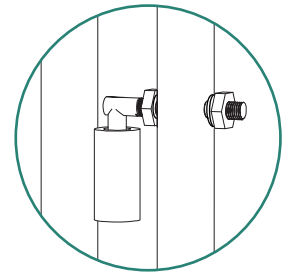
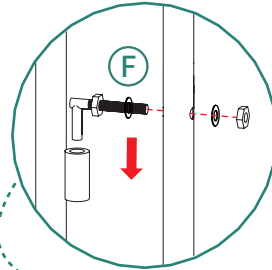

1

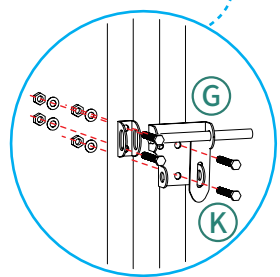
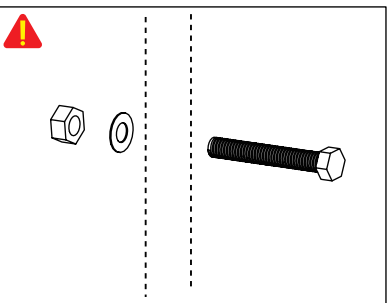
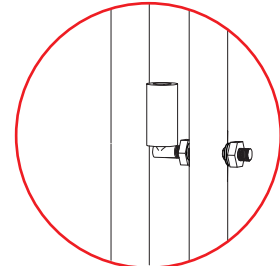
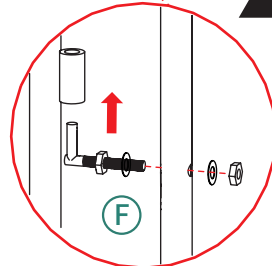

14

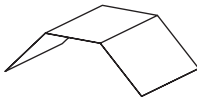

Ⓜ1pc



Ⓜ20pcs

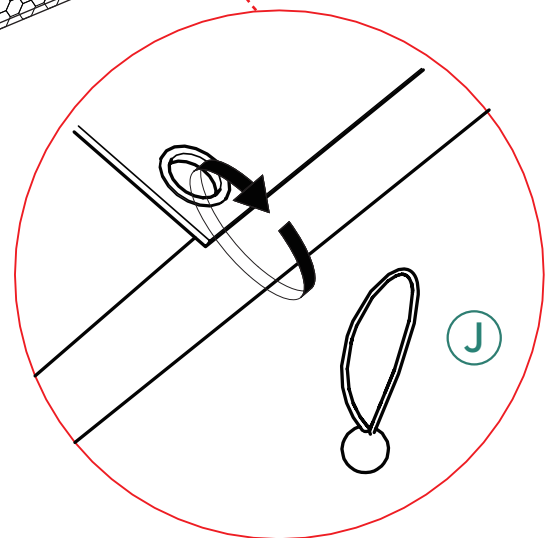
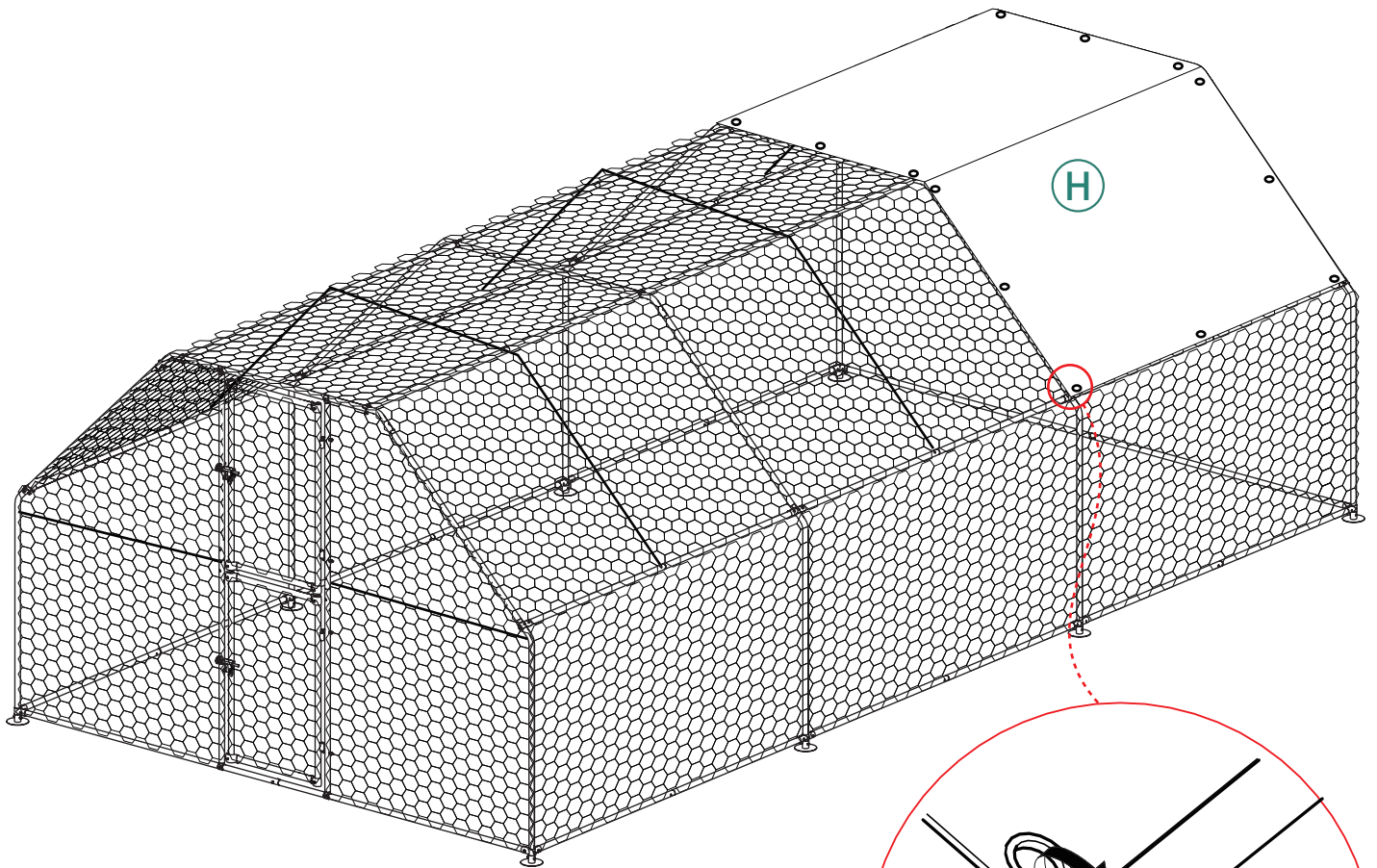

15



Ⓜ8pcs

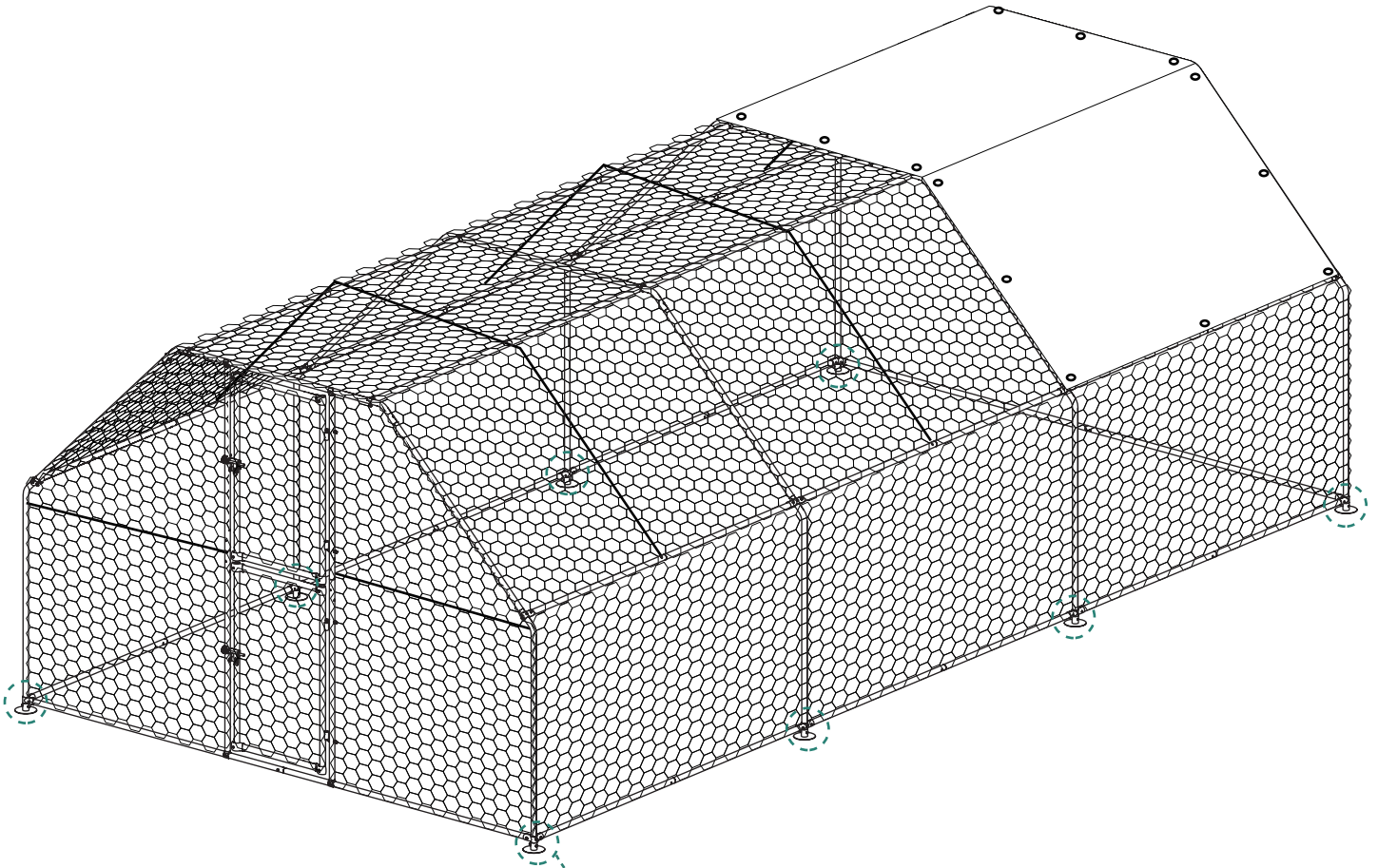

Installation Completed
Installation Abgeschlossen
Installation Complétée
Installazione Completata
Instalación Completada

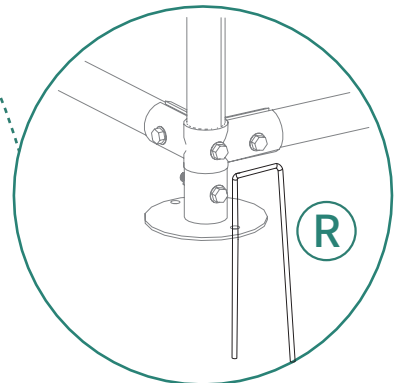

HELP CENTER



Inquiry



Assembly issue



Missing parts

If you encounter any difficulties during assembly, please contact us.
Wenn Sie während der Montage auf Schwierigkeiten stoßen, kontaktieren Sie uns bitte.
Si vous rencontrez des difficultés lors du montage, veuillez nous contacter.
Se incontri difficoltà durante il montaggio, ti preghiamo di contattarci.
Si encuentras alguna dificultad durante el ensamblaje, por favor contáctanos.

DISCLAIMER

Manufacturer and seller expressly disclaim any and all liability for personal injury, property damage or loss, whether direct, indirect, or incidental, resulting from the incorrect attachment, improper use, inadequate maintenance, unapproved modification, or neglect of this product.

Der Hersteller und Verkäufer lehnen ausdrücklich jegliche Haftung für Personenschäden, Sachschäden oder Verluste ab, egal ob direkt, indirekt oder zufällig, die durch falsche Anbringung, unsachgemäßen Gebrauch, unzureichende Wartung, nicht genehmigte Änderungen oder Vernachlässigung dieses Produkts entstehen.

El fabricante y vendedor renuncian expresamente a toda responsabilidad por lesiones personales, daños materiales o pérdidas, ya sean directos, indirectos o incidentales, derivados de la incorrecta colocación, uso inadecuado, mantenimiento insuficiente, modificación no aprobada o negligencia de este producto.

Il produttore e il venditore declinano espressamente ogni responsabilità per lesioni personali, danni materiali o perdite, dirette, indirette o incidentali, derivanti dall'errato fissaggio, uso improprio, manutenzione inadeguata, modifica non autorizzata o negligenza di questo prodotto.

Le fabricant et le vendeur déclinent expressément toute responsabilité en cas de blessures corporelles, de dommages matériels ou de pertes, qu'ils soient directs, indirects ou accessoires, résultant de la fixation incorrecte, de l'utilisation inappropriée, de l'entretien insuffisant, de la modification non approuvée ou de la négligence de ce produit.