

Accent chair

Complete drawing display

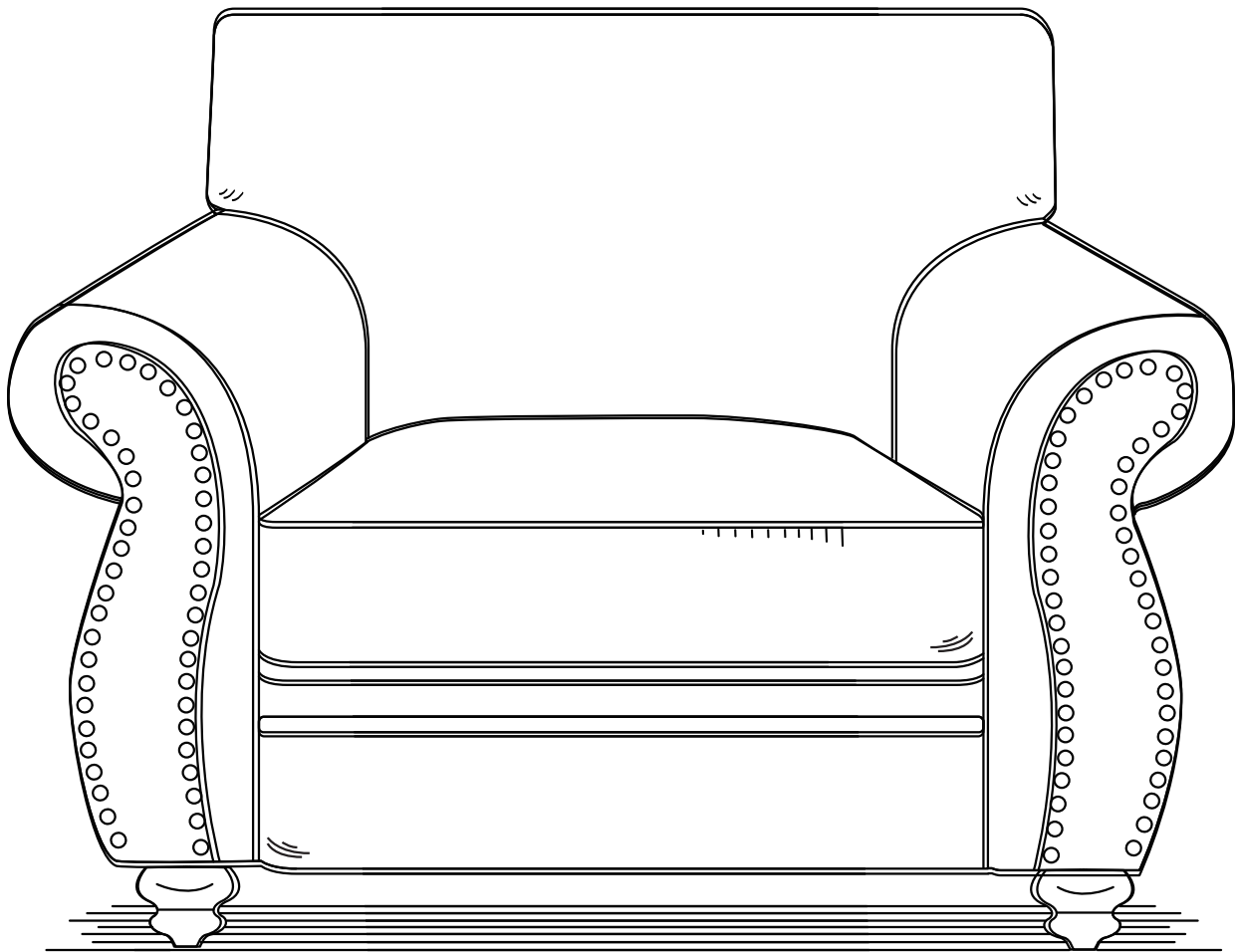

Model: C0006

Safety And Care Advice

Important - Please read these instructions carefully before installing

Thank you very much for purchasing the product. To use this product safely and correctly, please read these instructions carefully. After reading these instructions, keep this manual in a safe place for future reference. Although this product is expected to be complete and safe, please check that all accessory items are included before attempting to assemble the product. If you find anything in the instruction manual that is difficult to understand, or if you find a defect with the product, stop using it immediately and contact Customer Service.

Warnings :

Children are not allowed to assemble the product. During assembly, keep all small parts out of the reach of children as they may be fatal if swallowed or inhaled. Do not place in front of a fire or other heat source.



After-sales service



Fast installation



Teamwork Recommended



The product parts are packed in two separate cartons. Please wait to receive both complete cartons before proceeding with the installation.



Maintenance and Cleaning Methods

- 1.Regular Vacuuming:** Make it a habit to vacuum your fabric sofa regularly, at least once a week, to remove dust, dirt, and crumbs. Use a soft brush attachment to prevent damage to the fabric.
- 2.Spot Cleaning:** Deal with spills and stains immediately to prevent them from setting into the fabric. Blot the spill with a clean cloth or paper towel to absorb as much liquid as possible, then use a mild detergent mixed with water to gently clean the area. Always test any cleaning solution on a hidden area of the sofa first to ensure it doesn't cause discoloration.
- 3.Professional Cleaning:** Consider having your fabric sofa professionally cleaned at least once a year, especially if it's heavily used or if you have pets. Professional cleaners have the expertise and equipment to deep clean the fabric without causing damage.
- 4..Fluff and Rotate Cushions:** Regularly fluff and rotate the cushions on your sofa to ensure even wear and maintain their shape. This will help prevent sagging and prolong the life of the sofa.
- 5.Protect from Sunlight and Pets:** Position your fabric sofa away from direct sunlight to prevent fading and discoloration. If you have pets, consider using a protective cover or blanket to minimize damage from claws and hair.

By following these maintenance and cleaning tips, you can keep your fabric sofa looking fresh and inviting for years to come.



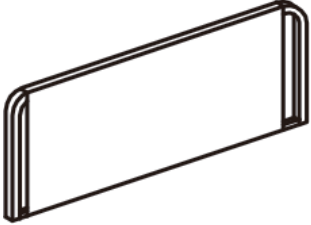

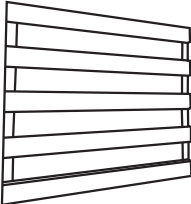
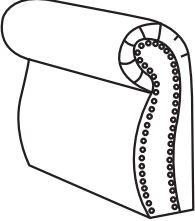
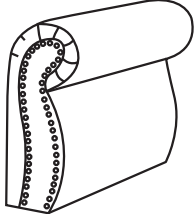
Parts List

The parts list is shown below

illustration	description	quantity
	Backrest	A×1
	Back connecting rod	B×1
	Front panel	C×1
	Supporting frame	D×1
	Left armrest	E×1
	Right armrest	F×1

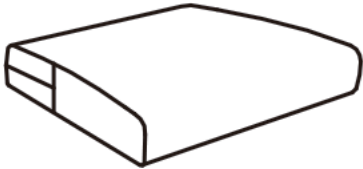
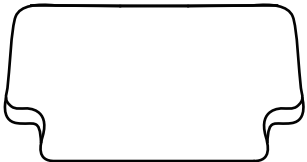
Parts List

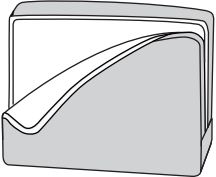
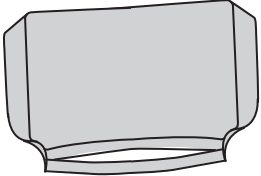
The parts list is shown below

illustration	description	quantity
	Seat cushion	G × 1
	Back cushion	H × 1
	Leg	I × 4
	Seat cushion cover	J × 1
	Back cushion cover	K × 1
	Bolt (8*20mm)	L × 8
	Bolt (8*40mm)	M × 4

Installation Procedure

Specific operations are shown in the following figure

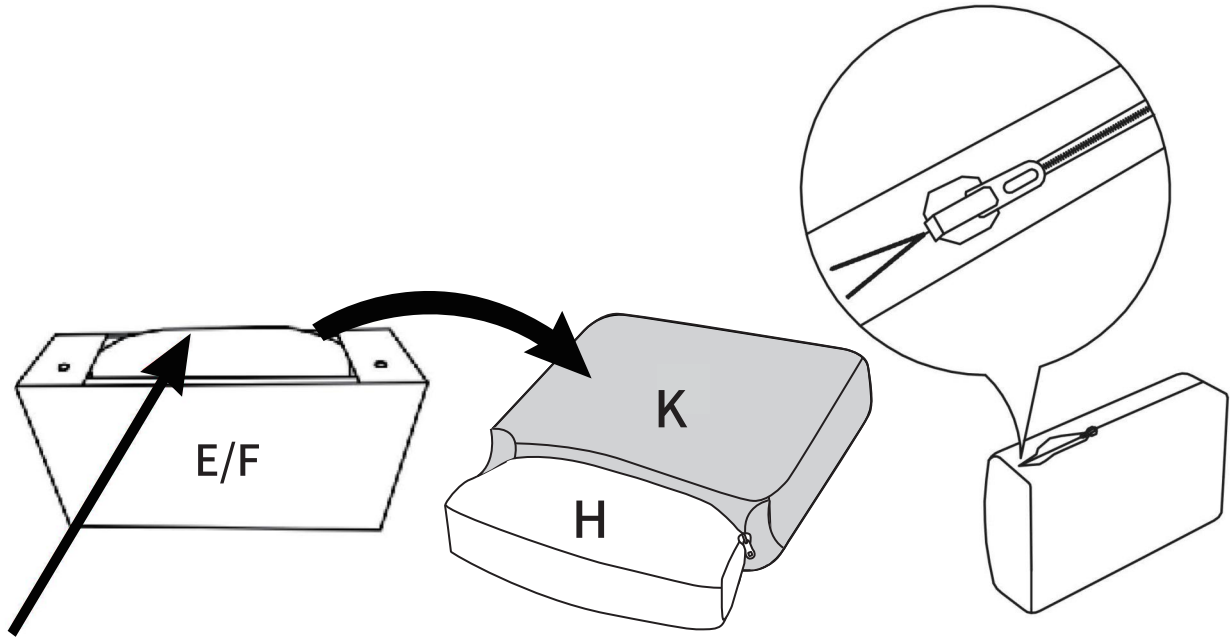

Step 1: Remove the cushions and covers from the inside of the armrests. Stuff the back cushion into the cover and zip it up. Note: There are 2 kinds of covers and the back cushion cover is smaller.

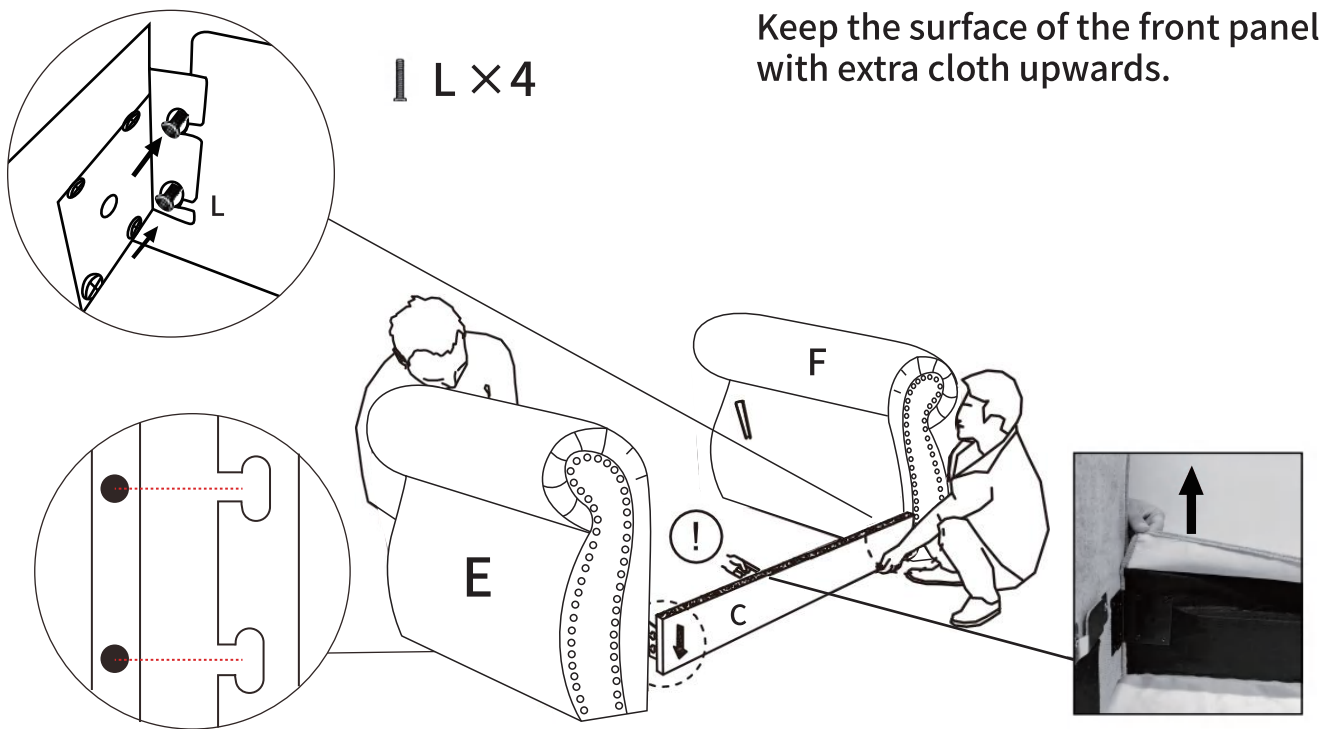

Step 2: Insert 4 M8 x 20mm screws into the pre-drilled holes on the sides of the armrests, without fully tightening them. Align the mounting clips on the front panel with the screws and attach the panel. Once it's securely in place, tighten the screws to securely fasten the front panel.

Installation Procedure

Specific operations are shown in the following figure

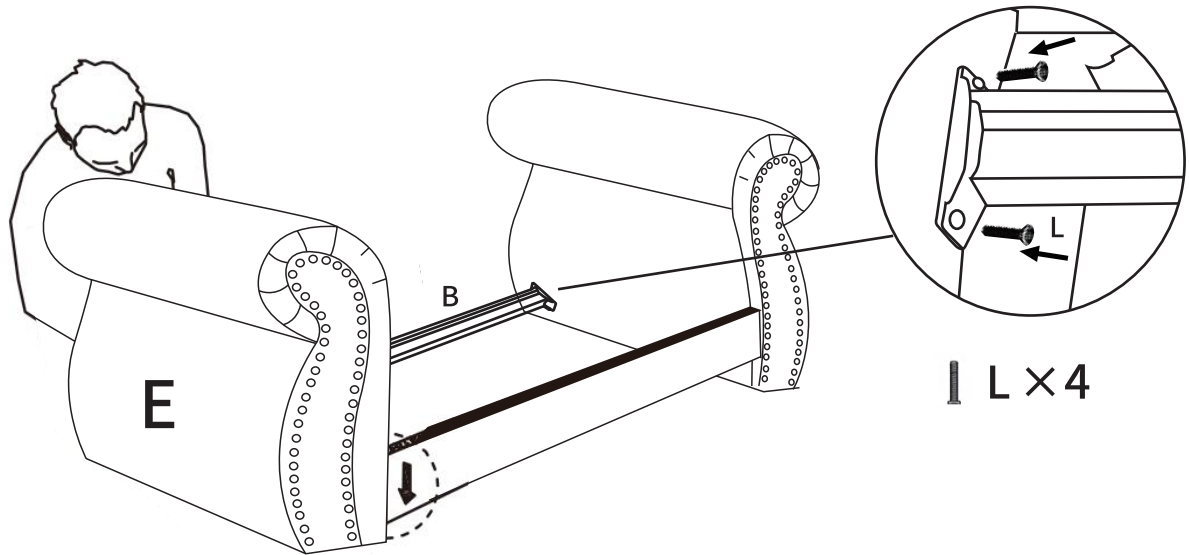

Step 3: Use 4 M8 x 20mm screws to lock the back connecting rod onto both sides of the armrests.

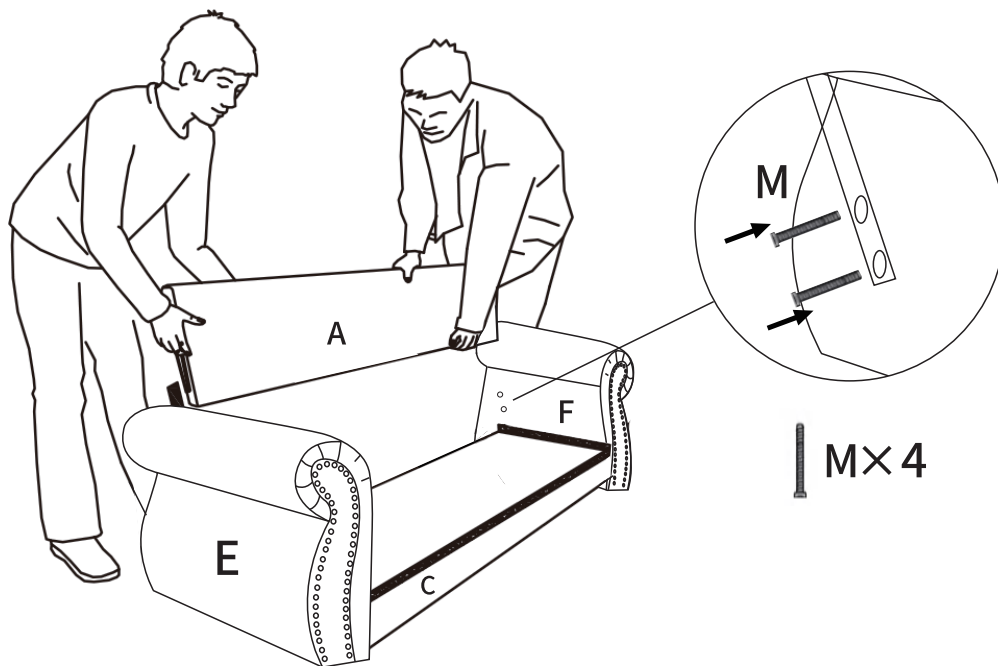

Step 4: Use 4 M8 x 40mm screws to lock the backrest onto both sides of the armrests.

Installation Procedure

Specific operations are shown in the following figure

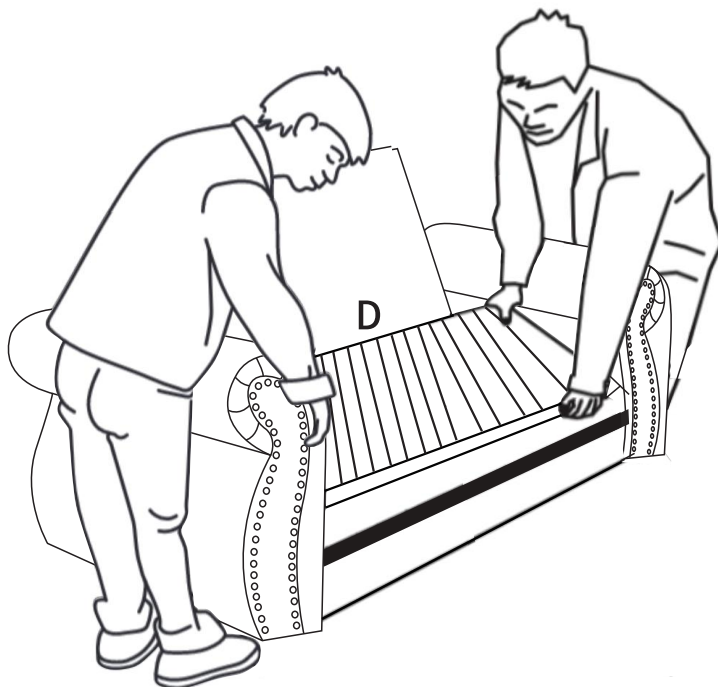

Step 5: Insert the supporting frame.

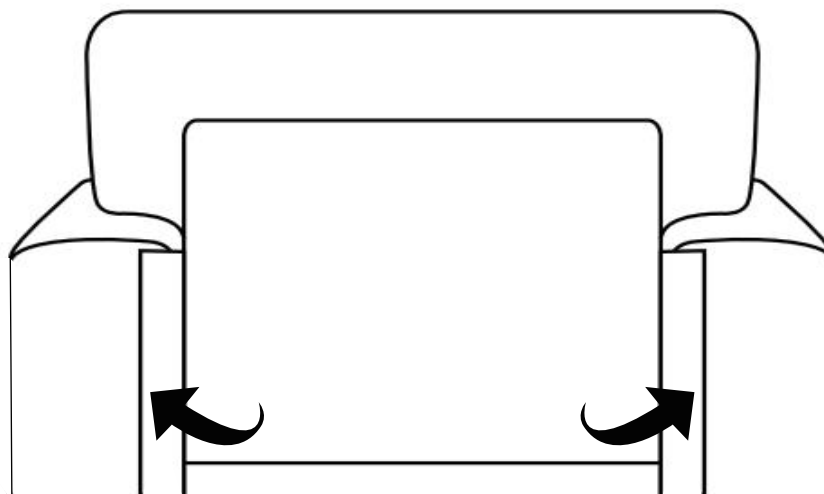

Step 6: Paste the Velcro of backrest onto the armrests and the bottom.

Installation Procedure

Specific operations are shown in the following figure

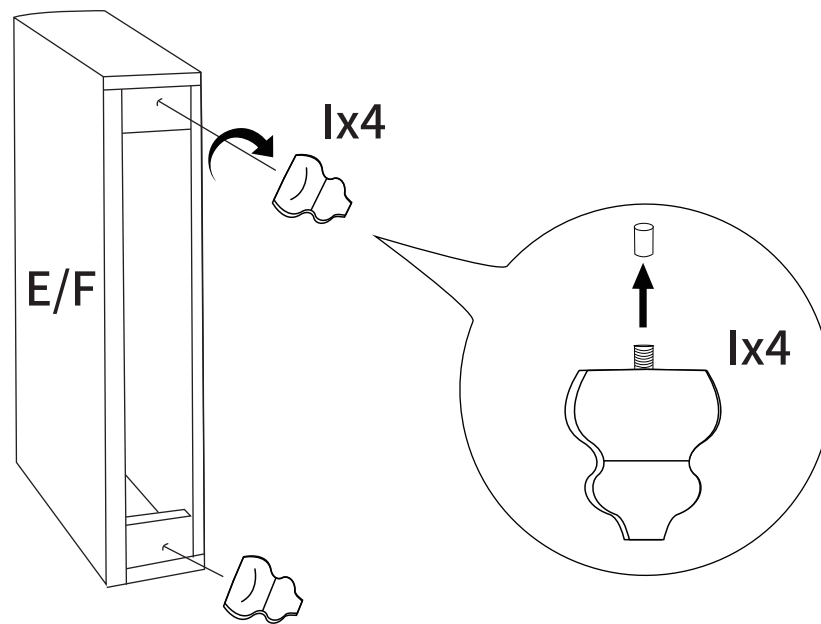

Step 7: Remove the plastic caps on the bolts of each leg. Flip the armrests upside down to screw the legs.

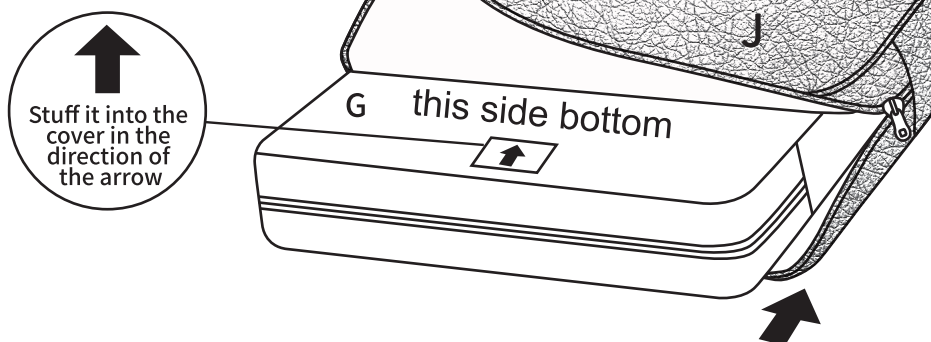
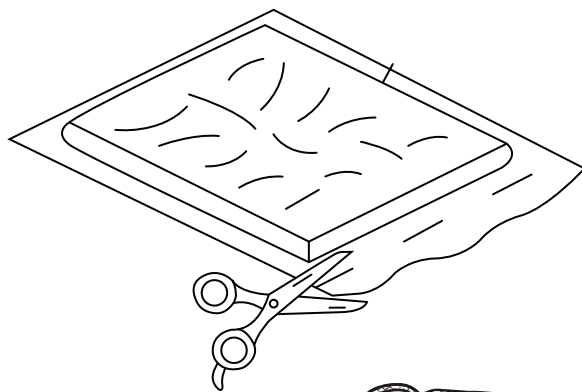

Step 8: Unpack the compression bag and get the seat cushions out. Stuff it into the seat cushion cover in the direction of the arrow. Zip it up as picture 1. Note: It will take about 48 hours for the cushion to expand completely.

Installation Procedure

Specific operations are shown in the following figure

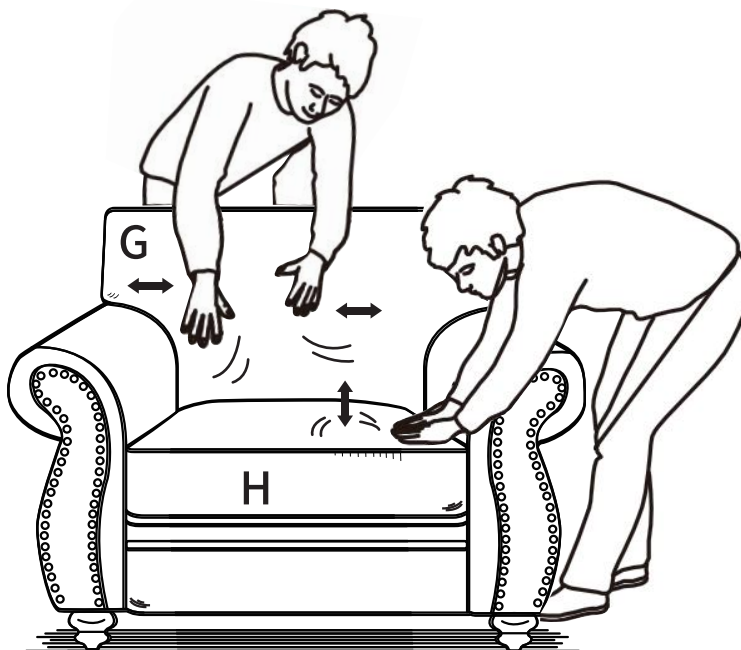

Step 9: Place the cushions and pat it to smooth out the wrinkle.



Should you have any questions,
don't hesitate to reach out to us!

After-Sales Service Support :

Toll Free Hot Line: (+1) 877-716-5001

Monday-Friday (9:00am-6:00pm)

Email: service@energyfic.com



Scan the QR code and register to extend the
warranty to 2 years!

