

# **Water Tank Base**

## **Assembly and Operation Manual**



# Check List



**A** x 4  
(M8x20)



**B** x 4  
(Ø8)



**C** x 1



**D** x 1



**E** x 1



**F** x 1

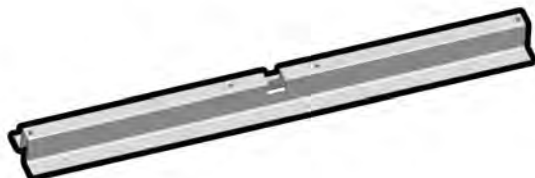

**G** x 1



**H** x 1

# Water Tank Base Assembly

1

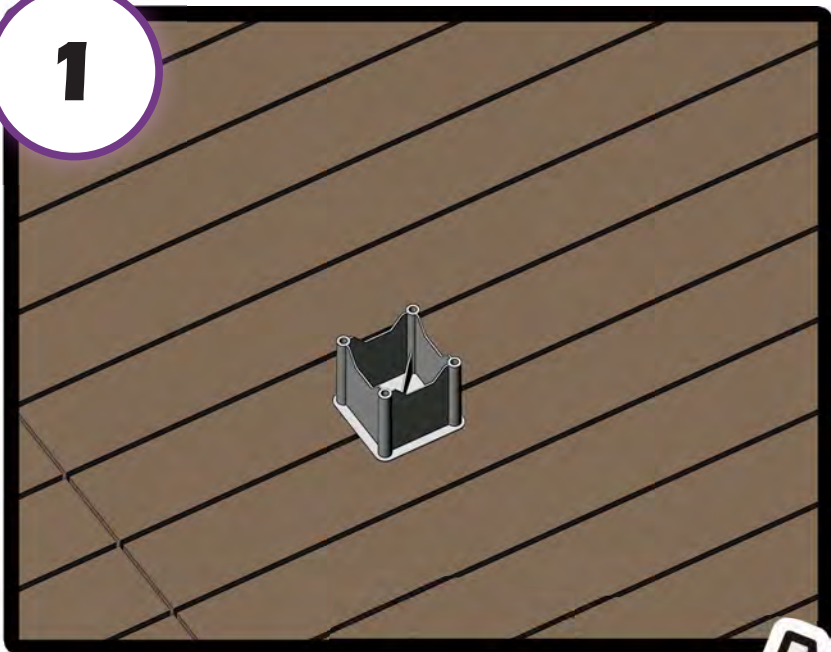

2

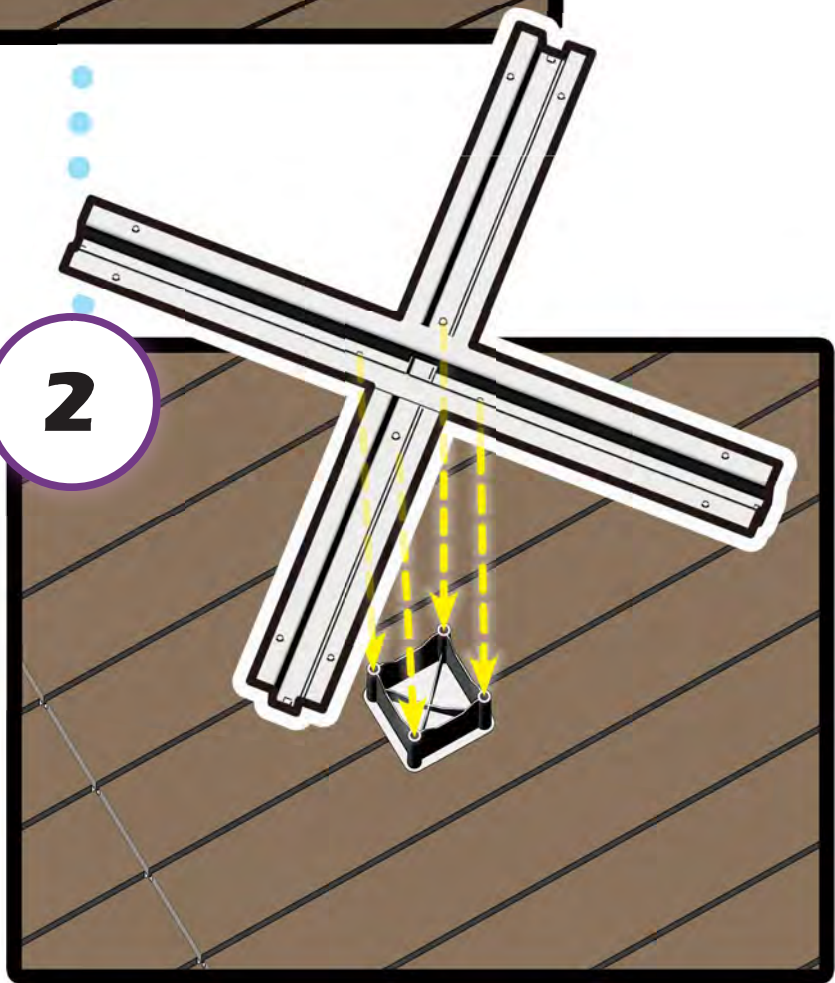

# Water Tank Base Assembly

4

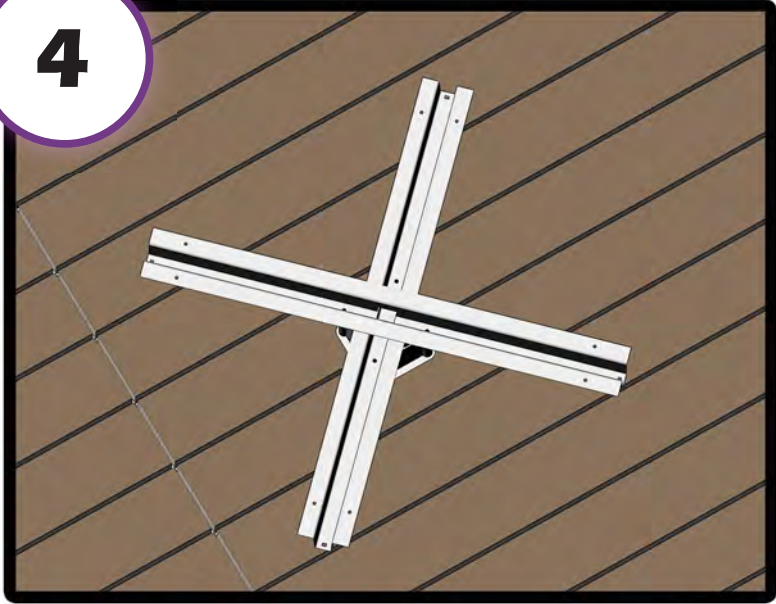

3

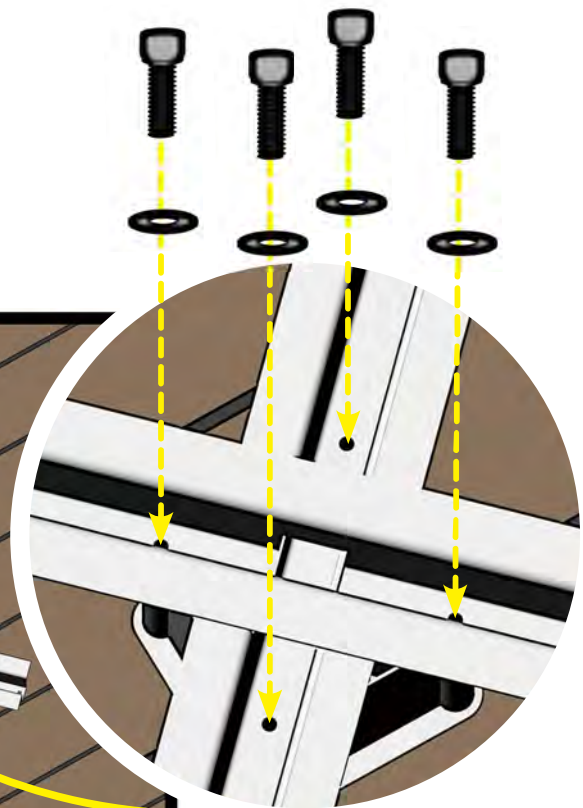
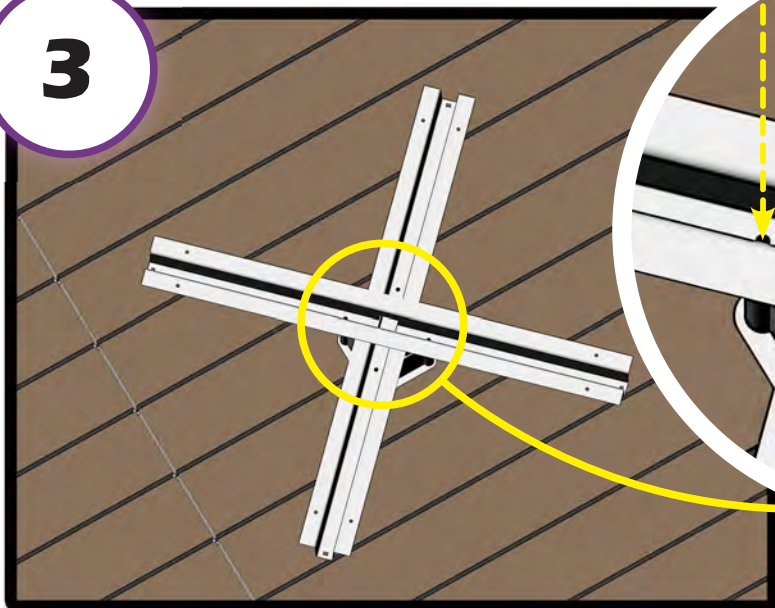

# Water Tank Base Assembly

5

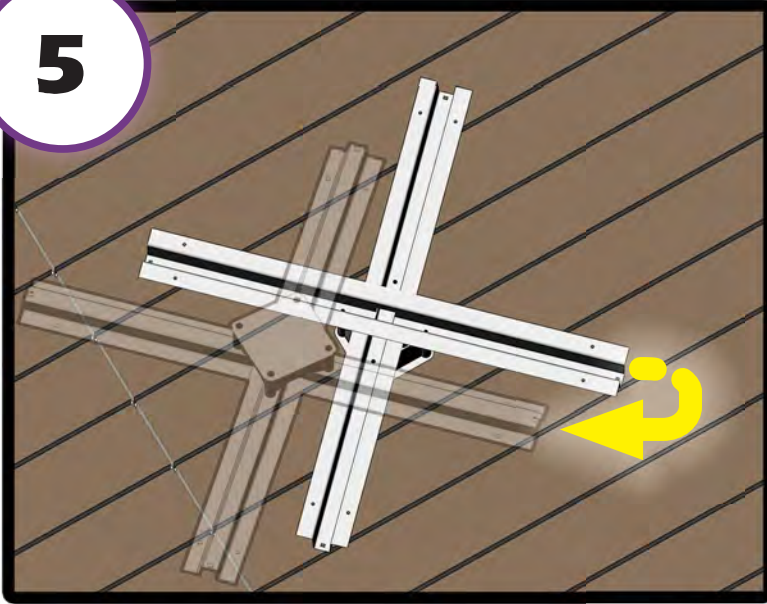

Flip it over.

6

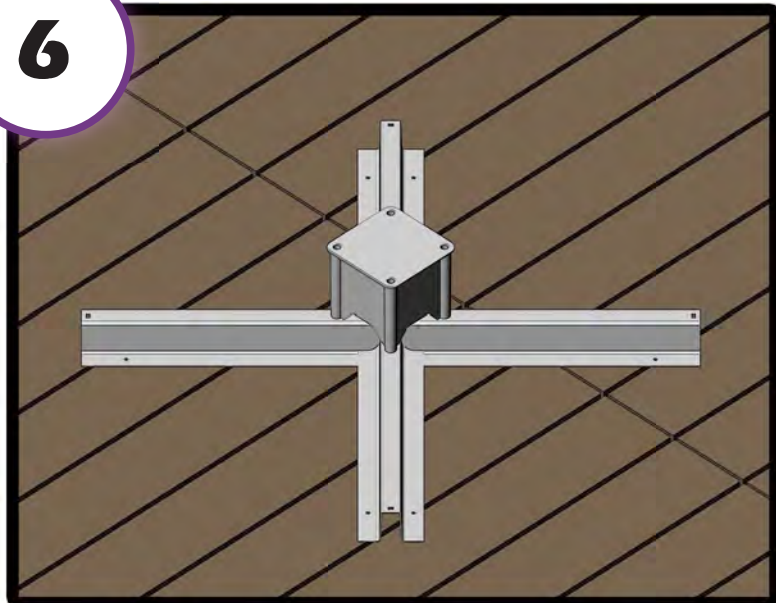

# Water Tank Base Assembly

8

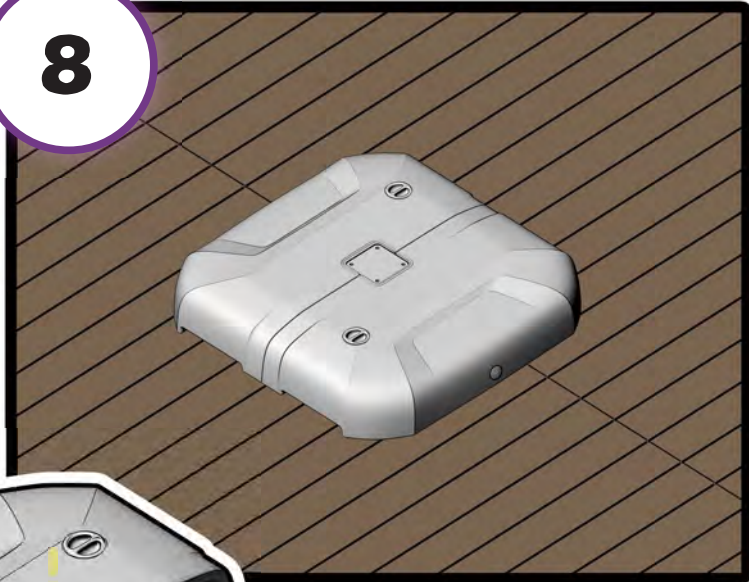

7

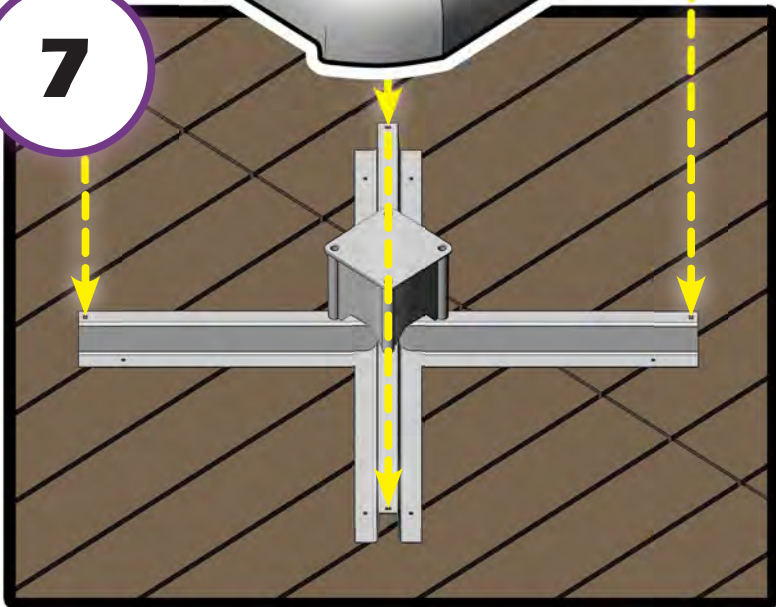

# Water Tank Base Operation

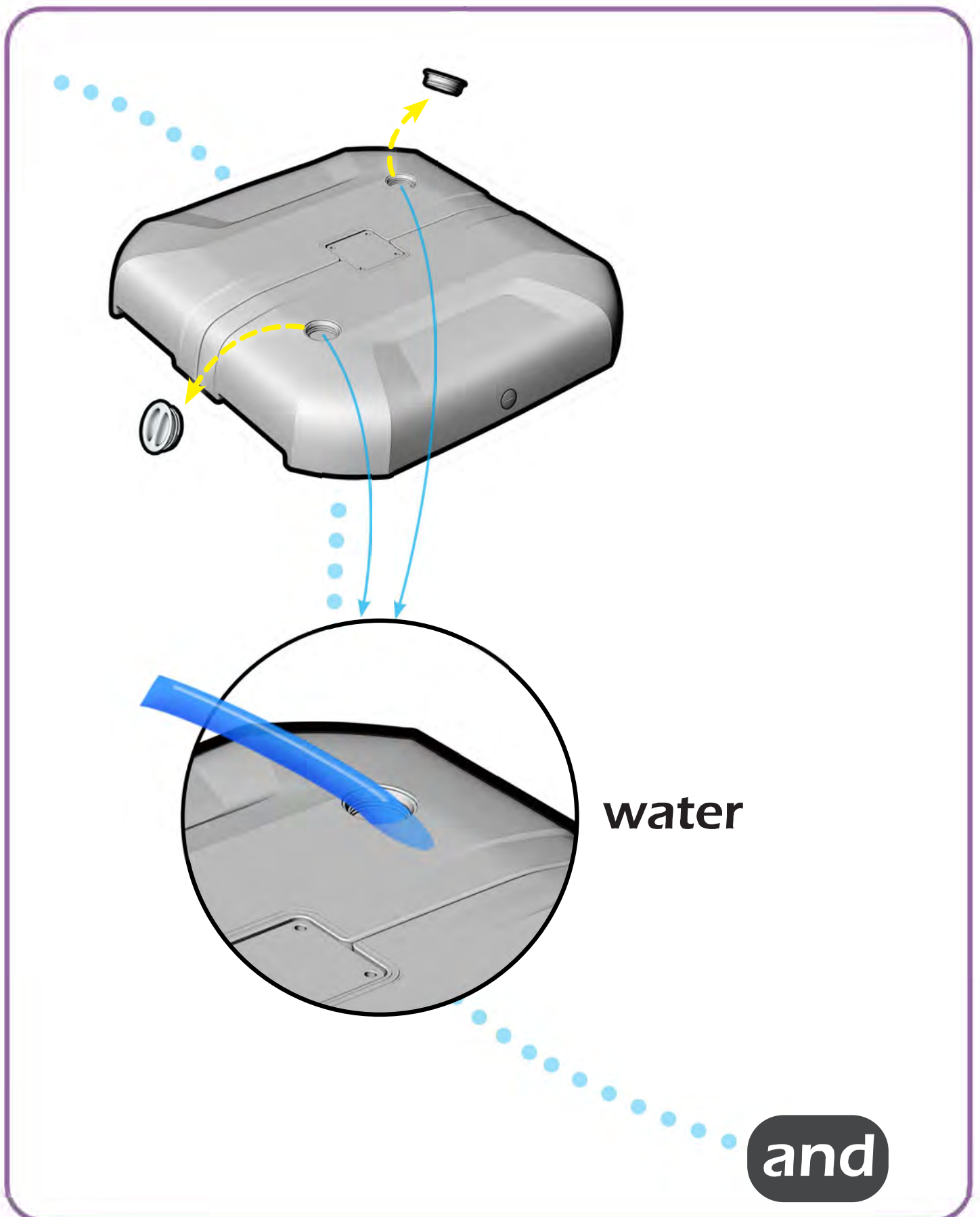

# Water Tank Base Operation

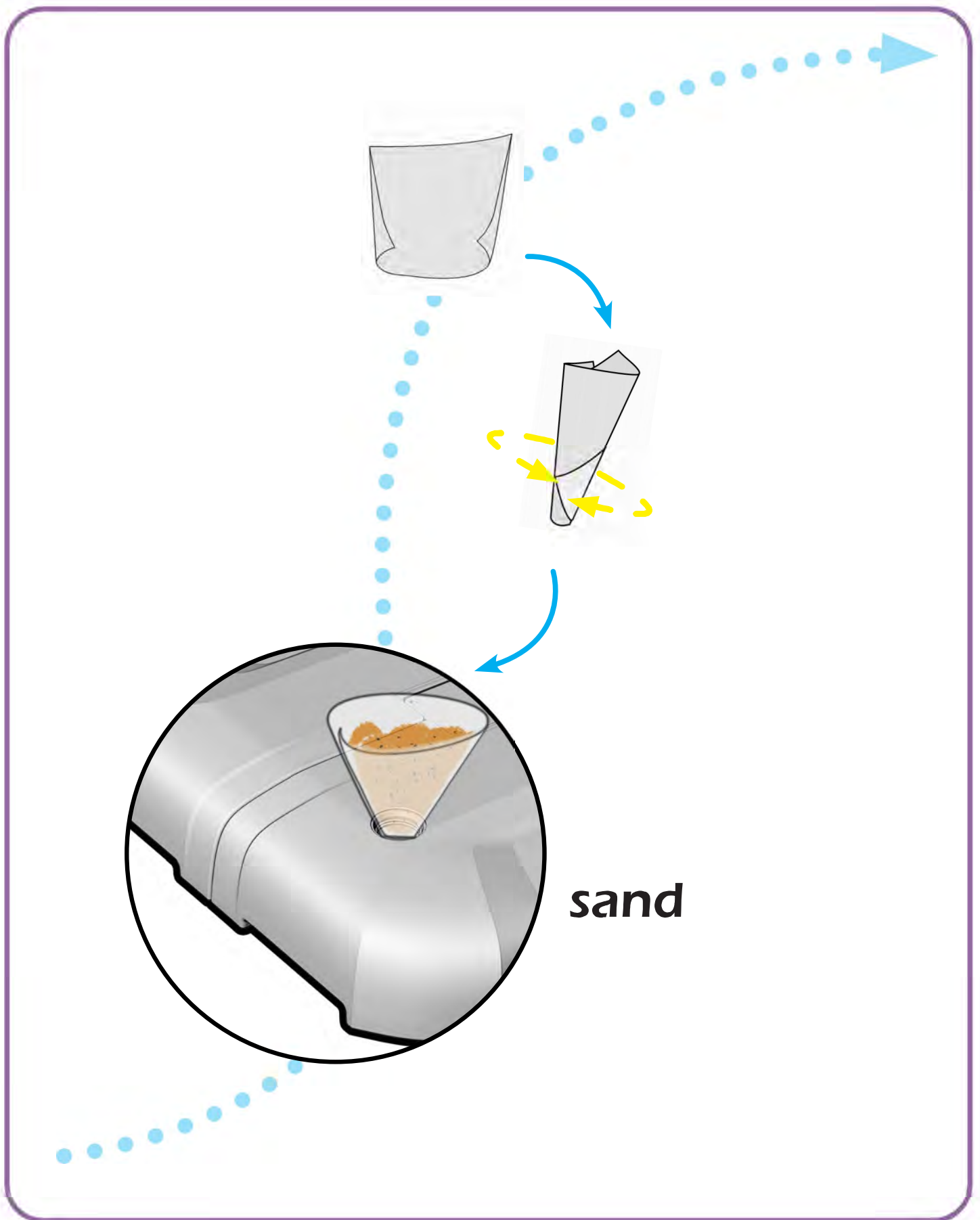

# Water Tank Base Operation



Remove two drain plugs to empty water from the base.

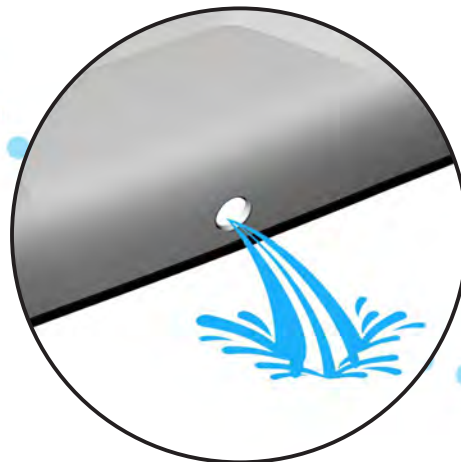
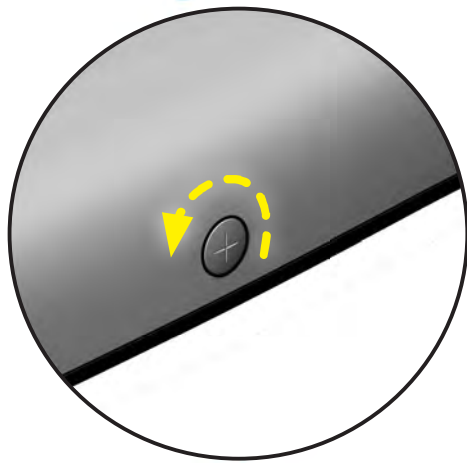

# WARRANTY

## **Tank**

Tank is warranted to be free from defects in materials and workmanship for a period of one year. Damage to tank or welds due to improper assembly and subfreezing temperatures is not covered.

## **Finish**

The finish is warranted against peeling, cracking, or blistering for a period of one year, provided the unit has not been scratched or abraded. Scratches and chips resulting from abnormal wear and tear are not covered. Fading resulting from exposure to chemical is not covered.

## **Note**

All operations should follow the instruction manual.

## **Exclusions**

Failure caused by inappropriate use; Failure caused by neglect of reasonable and necessary care; Acts of nature (including but not limited to wind, hurricanes, tornadoes, and storms) are not covered by this warranty.