

Important: Keep these instructions for future reference

Mini Gate with small pet door

Assembly and Installation Instructions
Please read these instructions carefully before installing your gate.

NOTE: DO NOT USE THIS GATE FOR CHILDREN.

This gate can be used in openings from 29 inches (including the main gate, one 6 and one 4 inch extensions) to 38 inches.

ADDITIONAL EXTENSIONS SOLD SEPARATELY.

Made In China.

Check that you have these contents:

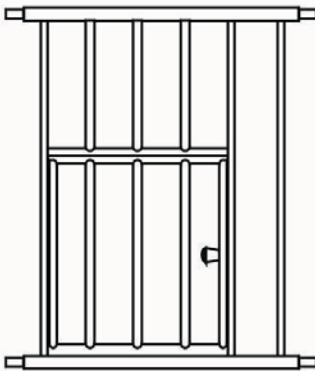

1. Main Gate Frame



2. Hardware Pack which should contain:

4 - Threaded Spindle Rods 

4 - Adjustable Wheel Spindles  (already assembled to the Spindle Threaded Rods)

4 - Wall Cups  4 - Screws  2 - Foot Stands 

3. Three Extensions

2 - 6" Extension 1 - 4" Extension

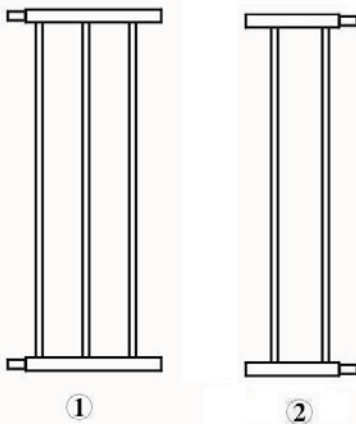

WARNING:

To prevent serious injury or death, securely install gate or enclosure and use according to manufacturer's instructions.

Important: The small pet door **MUST** be securely closed at all time.

Gate Extension Instructions

Important: Keep these instructions for future reference

Please read these instructions carefully. The safety of your children must be your responsibility.

Please follow these instructions carefully to ensure that your gate extension is properly installed. Improper installation could result in the gate becoming dislodged from the doorway, or unstable. Always make sure the extension is securely attached to the gate before using

It is preferable to install the extension on the hinge side of the gate. If you have an application that requires additional extensions, please contact the retailer which you purchased your gate from. We offer, the following sizes of extensions for your gate: 4 inch, 6 inch, 12 inch and 24 inch. They are available at most retailers that carry our Products line of metal gates.

Made in China.

Instructions for Gate Extension

Note: Never use more than two extensions per gate!

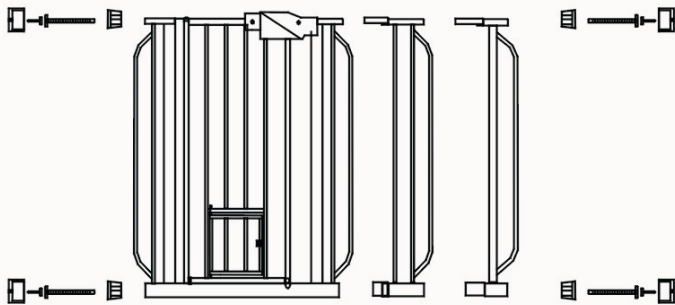

1. Assemble the gate per the gate instructions.
2. Choose the side of the gate to be extended and remove the top and bottom Adjustment Wheel Spindles.
3. Assemble the gate and extension as illustrated.
4. Reposition the gate and fit in accordance with the gate fitting instructions.

Important: Keep these instructions for future reference

Extra Wide Gate with pet door

Assembly and Installation Instructions
Please read these instructions carefully before installing your gate. If using this gate with a child, the safety of your child is your responsibility.

Note: If using this gate at the top of stairs, the 4 Wall Cups MUST be used. If not used, the gate could be dislodged from the opening.

This gate can be used in openings from 29 inches to 44 inches.



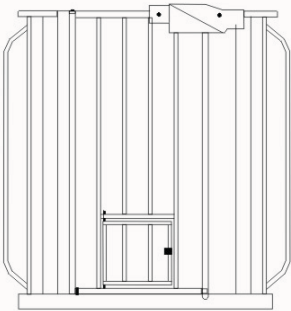

Made In China.

Check that you have these contents:

1. Gate Frame



2. Hardware Pack which should contain:

- 4 - Threaded Spindle Rods 
- 4 - Adjustable Wheel Spindles  (already assembled to the Spindle Threaded Rods)
- 4 - Wall Cups 
- 4 - Screws 

3. Two Extensions

- 1 - 6" Extension
- 1 - 4" Extension



⚠ WARNING:

To prevent serious injury or death, securely install gate or enclosure and use according to manufacturer's instructions. Never use with a child able to climb over or dislodge the gate or enclosure. Never leave child unattended. Use only with the locking/latching mechanism securely engaged. Important: The small pet door MUST be securely closed when the gate is being used with children.

Important: Keep these instructions for future reference

Extra Wide Gate with pet door

Assembling and Installing Your Gate

****Note: IMPORTANT you will notice a slight Gap between the gate door latch and the frame tube. THIS IS NOT A DEFECT. Your gate is a pressure mounted gate and this gap will disappear once you tighten your gate in the doorway.**

Step 1.

Begin by locating the 4 Threaded Spindle Rods. Before you begin, turn the Adjustment Wheels clockwise until they are almost against the flat end of the Threaded Spindle Rods. **WARNING: The Adjustment Wheel should NOT touch the flat end of the Thread Spindle Rod. If it does it might get stuck.**

Diagram A.

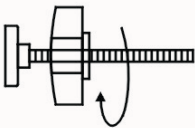

Step 2.

You are going to insert the 4 Threaded Spindle Rods into the holes in the 4 ends of the gate frame as shown in Diagram B1. ****IMPORTANT: THE ENDS OF THE GATE FRAME ARE NOT THREADED. THE THREADED SPINDLE ROD SHOULD SLIDE INTO THE END OF THE FRAME TUBES WITHOUT ANY RESISTENCE. Push the Threaded Spindle Rods all the way into the frame tube until the Adjustment Wheel hits the end of the frame tube as shown in Diagram B2.**

Diagram B 1

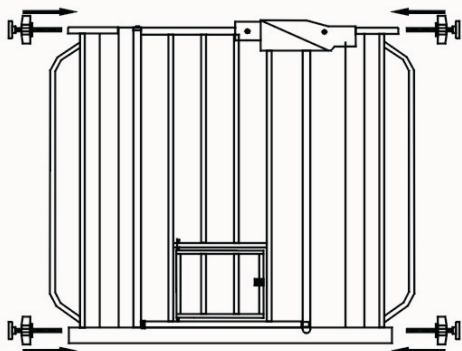
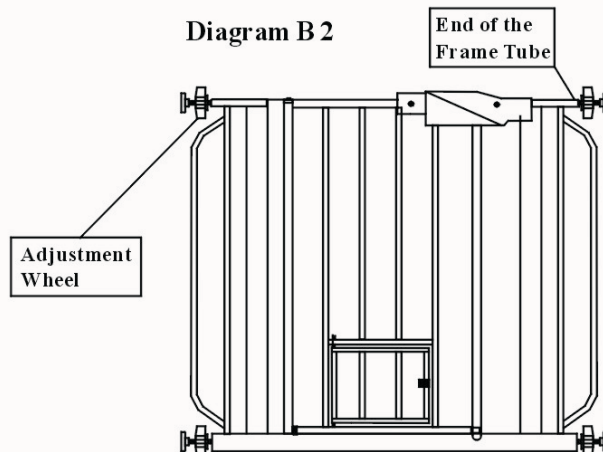

Diagram B 2



Important: Keep these instructions for future reference

Extra Wide Gate with pet door

Step 3.

Positioning and Attaching the Wall Cups to your door opening.

Your gate is a pressure mounted gate. Therefore it is not necessary to use the screw attached Wall Cups to your door opening if you choose not to. However, **IF YOU ARE USING THE GATE AT THE TOP OF STAIRS YOU MUST USE THE WALL CUPS.**

Regardless of whether you are using your gate at the top of stairs or not, using the Wall Cups will affix your gate more firmly in the doorway. So you may choose to use them in all applications. If you choose not to use the Wall Cups you may skip to Step 4 now.

Before attaching your Wall Cups to your doorway opening you must make sure you have the screw holes marked correctly. To do this, simply position your gate in the doorway so that it is level and centered as shown in Diagram C-1. Then, place the Wall Cups over the flat end of the Threaded Spindle Rods which should already be fully inserted into the ends of the gate frame tubes as shown in Diagram C-2. Pull the Threaded Rods out until the Flat end with the Wall Cup is against the wall. Pull all four Threaded Spindle Rods out in this manner. Then take a pencil and make a light mark on the wall around the parameter of the Wall Cups. Once you have marked the correct spots on your walls you can move the gate aside. Next, you will need to mark the Screw Holes. To this simply take a Wall Cup and center it on each pencil circle you marked on your wall. Use a pencil to mark the small Screw Hole in the center of the Wall Cup. You are now ready to fasten your Wall Cups to the Wall using the self tapping screws included in the hardware packet.

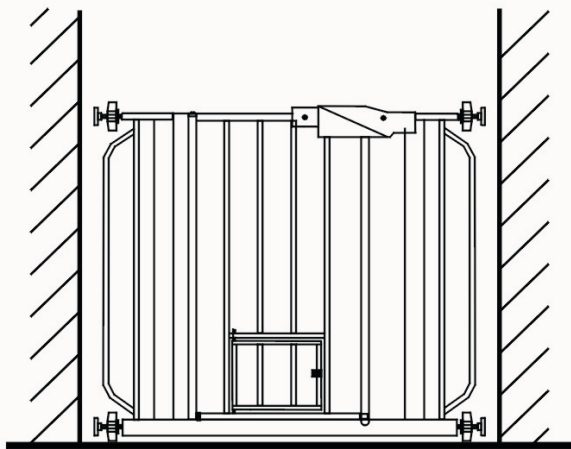

C - 1

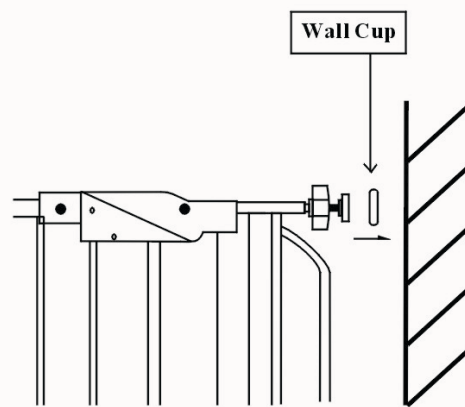

C - 2

Important: Keep these instructions for future reference

Extra Wide Gate with pet door

Step 4.

You are now ready to install your gate in the doorway. Begin by positioning your gate level and centered in the doorway opening. Pull the 4 Threaded Spindle Rods out of the ends of the frame Tubes until the Flat Plastic End touches the wall. **If you are using the Wall Cups then the flat plastic ends of the Threaded Spindle Rods should go into the Wall Cups that are fastened to your wall. Next, while holding the flat plastic ends of the Threaded Spindle Rods against the wall, turn the Adjustment Wheels counter-clockwise until the Adjustment Wheels are up against the ends of the frame tubes as shown in Diagram D. DO NOT TIGHTEN. Go to Step 5 for Final Adjustment. HELPFUL HINT: It may be necessary to hold the Threaded Spindle Rod while turning the Adjustment Wheel to ensure the Threaded Spindle Rod does not turn.

Diagram D.

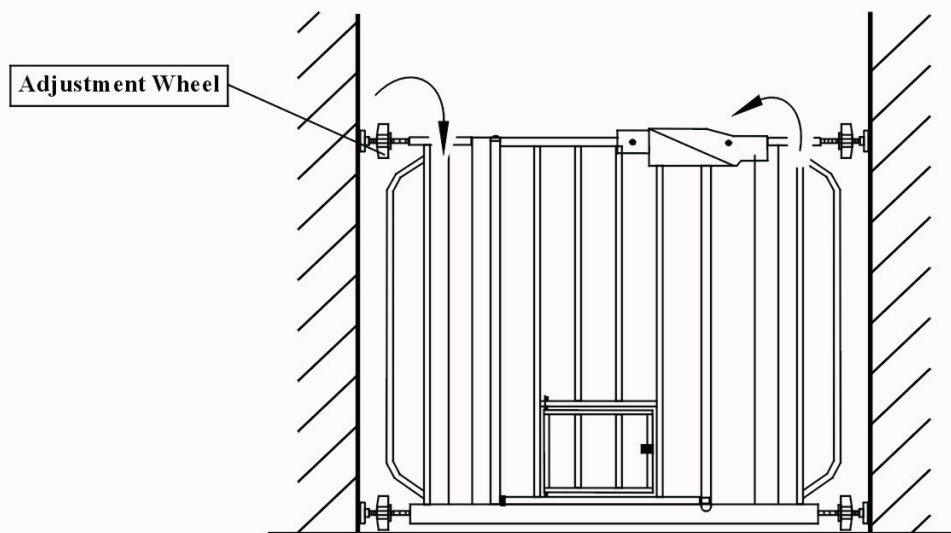

Important: Keep these instructions for future reference

Extra Wide Gate with pet door

Step 5.

You are now ready to do the Final Adjustment to fasten your gate firmly in the doorway. Start by turning the **BOTTOM Adjustment Wheels FIRST**. Continue to turn the lower Adjustment Wheels counter-clockwise until the Adjustment Wheels are firmly against the ends of the frame tubes. . **IMPORTANT: There should be equal space on each side of the gate.** To easily determine this look at the length of threaded rod is that is showing on each side. If the gate is centered, there will be an equal length of threaded rod showing. If more threaded rod is showing on one side you can adjust this using the Adjustment Wheels. Simply turn the side that has too much Threaded Rod showing clockwise, and then turn the other side counter-clockwise. As you do this you will see the sides equaling out as shown in Diagram E.

Diagram E.

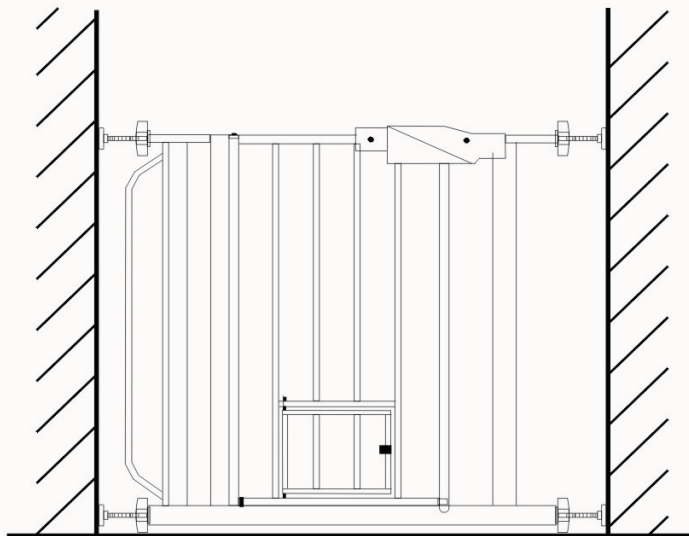

Important: Keep these instructions for future reference

Extra Wide Gate with pet door

Next, tighten the top 2 Adjustment Wheels by turning them counter-clockwise. Again, make sure both sides are equal as you tighten. As you tighten the Adjustment wheels you will notice the gap between the plastic gate door latch and the frame tube is narrowing. As the gap continues to narrow continue turning the upper Adjustment Wheels until the frame tube engages in the slot in the plastic gate door handle. Leave a 1/16" gap between the frame tube and the plastic gate door latch as shown in Diagram F. **IMPORTANT: The frame tube MUST NOT touch the Plastic gate door latch. If it does touch you have turned the Adjustment Wheels a few too many turns. To correct this simply turn the upper Adjustment wheels clockwise a few turns until you have a 1/16th inch gap. Your gate is now ready to use.**

Diagram F .

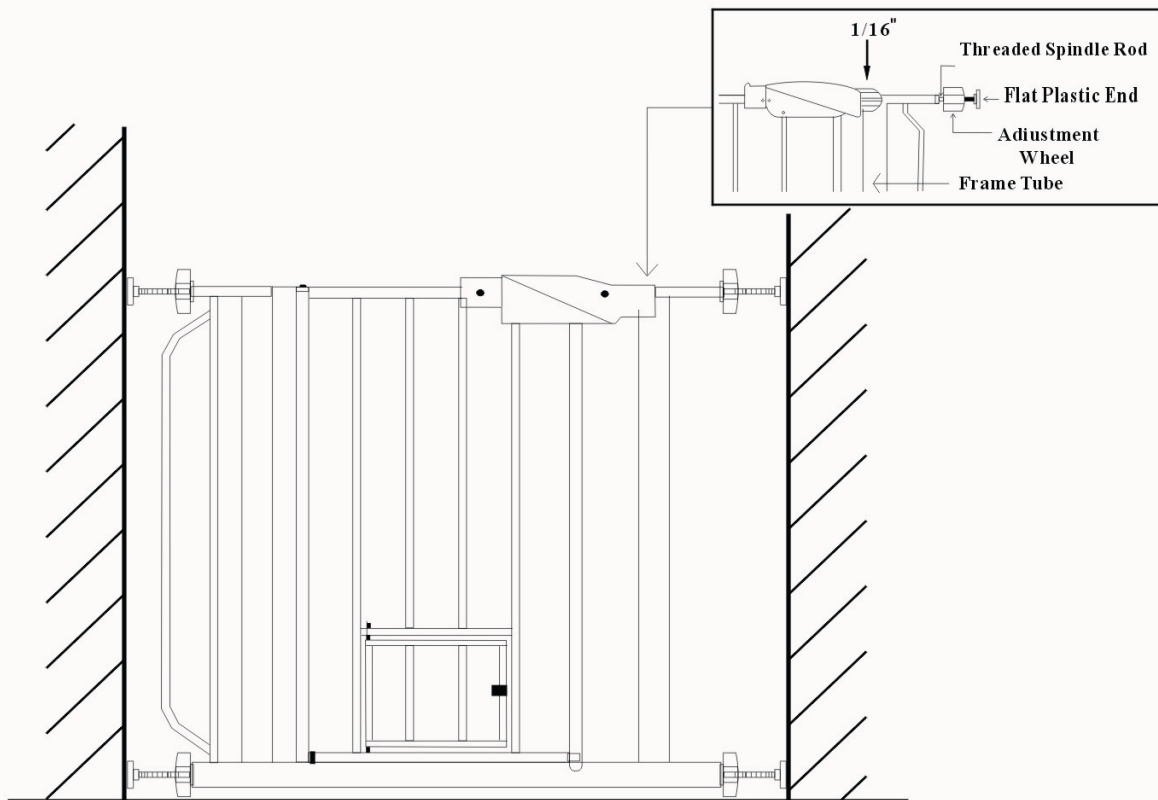

Important: Keep these instructions for future reference

Extra Wide Gate with pet door

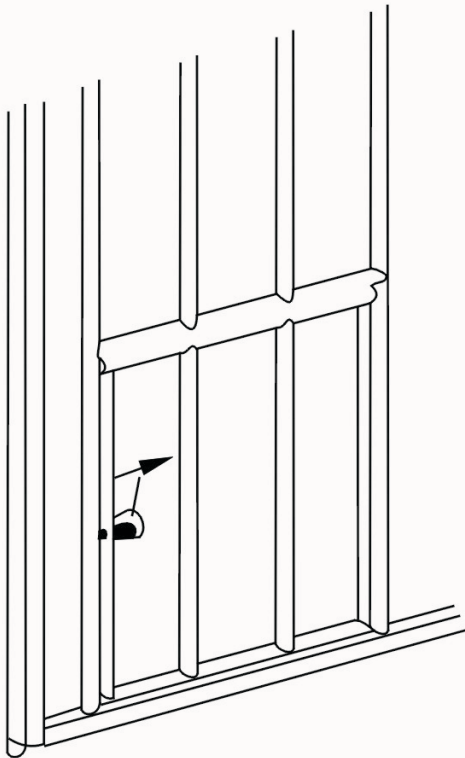

TO OPEN the small pet door, pull knob out and swing the door open.

Diagram (G-1)

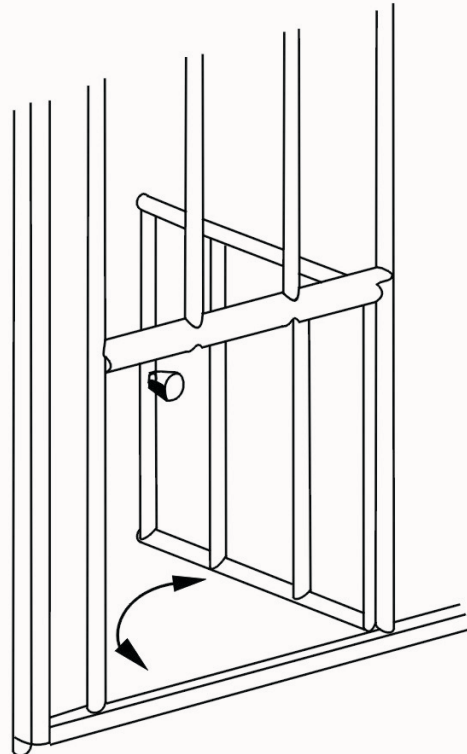

TO CLOSE the small pet door, pull the knob out and shut the door. Once the locking pin is aligned with the hole in the gate frame, release the knob.

Diagram (G-2)

Important: The Small Pet Door is to remain closed and securely locked when gate is used for children.