

USER GUIDE



ELECTRIC FIREPLACE

COMPONENTS



Fireplace



Remote



Upper Wall Bracket



Screw (x6)



Wall Plug (x6)



Washer (x6)



Pebbles 1.2Kg

Crystals 0.66Kg

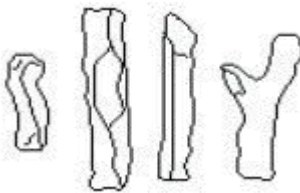

Logs (x4)

Please Note: Some parts are package within the cavity of surround on the rear of the fire.

SAFETY INFORMATION

When using electrical appliances, basic safety precautions should always be followed, including the following:

- **IMPORTANT:** Read all instructions and warnings carefully before starting installation. Failure to follow these instructions may result in a possible electric shock or fire hazard and will void the warranty.
- Before connecting the appliance, be sure that the mains voltage available matches that specified on the rating plate, and that the outlet is suitably grounded.
- This appliance can be used by children aged from 8 years and above and persons with reduced physical, sensory or mental capabilities or lack of experience and knowledge if they have been given supervision or instruction concerning use of the appliance in a safe way and understand the hazards involved.
- Children aged from 3 years and less than 8 years shall only switch on/off the appliance provided that it has been placed or installed in its intended normal operating position and they have been given supervision or instruction concerning use of the appliance in a safe way and understand the hazards involved. Children aged from 3 years and less than 8 years shall not plug in, regulate, or clean the appliance or perform user maintenance.
- Children under 3 years should be kept away unless continuously supervised.
- Some parts of this product can become very hot and cause burns. Particular attention has to be given where children and vulnerable people are present.
- If the supply cord is damaged, it must be replaced by the manufacturer, its service agent or a similarly qualified person in order to avoid a hazard.

- **WARNING:** In order to avoid overheating, do not cover the heater.
- **CAUTION:** In order to avoid a hazard due to the inadvertent resetting of the thermal cut-out, this appliance must not be supplied through an external switching device, such as a timer, or connected to a circuit that is regularly switched on and off by the utility.
- Do not attempt to repair, disassemble or modify the appliance. This unit contains no user-serviceable parts.
- Always unplug or disconnect the appliance from the mains power supply when not in use, or when moving or cleaning it. Do not pull the cord to unplug the heater.
- Keep the heater clean. Do not allow any object to enter the ventilation or exhaust opening as this may cause electric shock, fire, or damage to the heater.
- Do not use the appliance for other than its intended use. It is designed for domestic indoor use only.
- There may be a trace of odour during the first few minutes of initial use, or after a period of storage. This is normal and will quickly disappear.
- If the glass is damaged, do not use the heater in order to avoid a hazard.
- Avoid the use of an extension cord, as the cord may overheat and cause a risk of fire.
- This fireplace is hot when in use. To avoid burns, do not let bare skin touch any hot surfaces.
- Keep combustible materials, such as furniture, pillows, bedding, papers, clothes and curtains at least 1 metre from the front and sides of this appliance.
- This appliance is designed for indoor use only and is not intended for use in bathrooms, laundry areas and similar indoor locations. Never locate this appliance where it may become exposed to water.
- Do not place this fire directly onto a carpeted surface to avoid discolouration due to the heat.

- Do not run the cord under carpeting. Do not cover the cord with throw rugs, runners or the like. Ensure the cord is kept away from traffic areas, and kept in a position which would not present a trip hazard.
- To disconnect this appliance, Press the On/Off button to turn off, then remove the plug from the outlet.
- This appliance has hot and arching or sparking parts inside. Do not use it in areas where gasoline, paint, or any flammable liquids are used or stored.
- This appliance should not be used as a drying rack for clothing, nor should Christmas stockings or decorations be hung on or near it.
- This electric fire is an instant heat source to warm up a room and is great for visual room ambiance it doesn't necessary need to be used as a constant or permanent source of heating for the home.
- Clean the fire regularly to prevent the build-up of hairs dust or lint around the fire, as this may cause the outlet to become blocked.
- Do not use aerosols or steam cleaners on or around the fire.

Manual Handling

- The heater must not be moved while in use. Please allow a suitable amount of time for the unit to cool before attempting to move it.
- One person should be sufficient to lift the heater. If for any reason it is considered too heavy then obtain assistance.
- When lifting always keep your back straight. Bend your legs and not your back.
- Avoid twisting at the waist. It is better to reposition your feet.
- Avoid upper body / top heavy bending. Always bend from the knees rather than the waist. Do not lean forward or sideways whilst handling the heater.
- Always grip with the palm of the hand. Do not use the tips of fingers for support.
- Always keep the heater as close to the body as possible. This will minimize

the cantilever action.

- If required, use gloves to provide additional grip.
- Always use assistance if required.

ELECTRICAL SAFETY

The heater must not be located under an electrical socket; the socket must always be accessible in order to disconnect the heater from the electrical supply for maintenance and cleaning.

Important! This heater must be earthed. The mains supply must be safely routed from the heater to an electrical socket.

If the supply cord is damaged, it must be replaced by the manufacturer, service agent or a similarly qualified person in order to avoid a hazard.

This appliance is supplied with a BS1363 3 pin plug fitted with a 13 Amp fuse. Should the fuse require replacement, it must be replaced with a fuse rated at 13Amp and approved to BS1362.

In the event the mains plug has to be removed or replaced for any reason, please note:

The wires in the mains lead on this appliance are coloured in accordance with the following code:

Green and Yellow - Earth
Blue - Neutral
Brown - Live

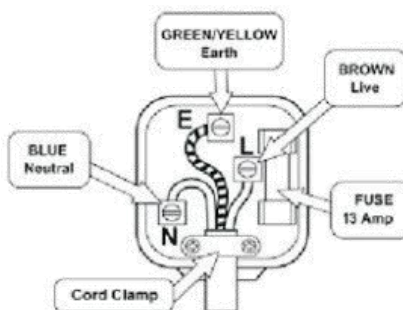

As the colours may not correspond with the markings identifying the terminals in your plug, please proceed as follows.

- The green and yellow wire must be connected to the terminal in the plug which is marked with the letter E or with the earth symbol \perp coloured green and yellow.
- The blue wire must be connected to the terminal marked N or coloured black.
- The brown wire must be connected to the terminal marked L or coloured red.

Important - any cut off plug should be disposed of safely to prevent a hazard. There is a danger of electric shock if a cut off plug is inserted into a socket outlet.

PRODUCT DIAGRAM

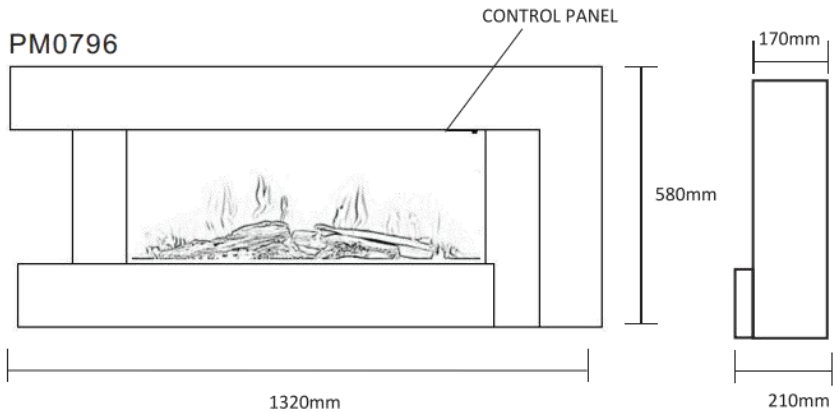

BEFORE USE!

Before using the appliance for the first time, ensure that it has been fully unpacked, and that all packaging has been disposed of properly to ensure it does not present a risk to children or animals.

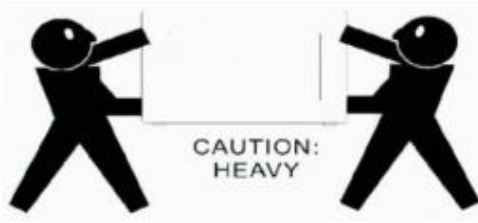

Due to the size and weight of the fire, we would advise on 2 people carrying out installation to prevent injury or damage.

INSTALLATION INSTRUCTIONS

This product is designed to be mounted flat to the wall. Before installation please ensure that the floor and wall are flat, and there is nothing that would prevent the fire fitting flush.

1. The fire is designed to be permanently fixed to a wall with a minimum distance of 300mm between the base of the fire and the floor. A distance of 600mm is recommended for the optimum height on the wall.
2. The upper bracket should be placed against the wall 490mm above the planned position of the base of the fire.
3. While ensuring that the bracket is level (using a spirit level) mark the position of the six screw holes in the wall.
4. Put the bracket to one side, drill the holes marked in step 3 with an 8mm drill bit to a depth of around 35mm.
5. Clean any dust and debris from drilling, and insert a wall plug into each hole, ensuring they are flush with the surface of the wall.

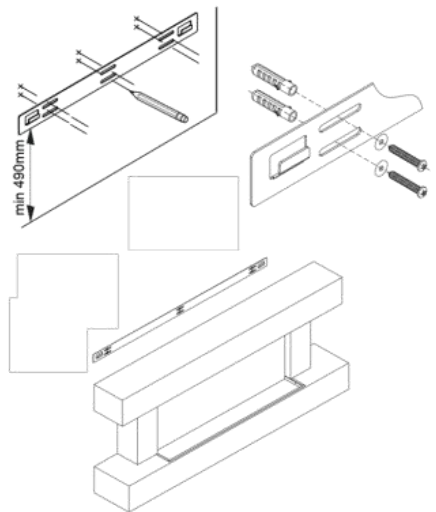

6. Hold the bracket in position and attach to the wall using 6 screws.
7. Two people should carefully lift the fire into position, ensuring the top edge of the fire engages with the bracket.
8. Spread the supplied pebbles / branches (model dependant) in position on the light at the front of the unit.

NOTES:

The wall plugs supplied are designed for solid walls, and so depending on the type of wall, a different type of plug may be required.

Before drilling into the wall, you must ensure that there is no pipework or wiring behind the wall which may be damaged during installation.

The fire must be installed by a competent person, if in any doubt about installation, the suitability of the wall, or wall plugs supplied, professional advice should be sought.

OPERATION

CONTROL PANEL

HIGH HEAT

Press to put the unit in high heating mode (2kw)

LOW HEAT

Press to put the unit in low heating mode (1kw)

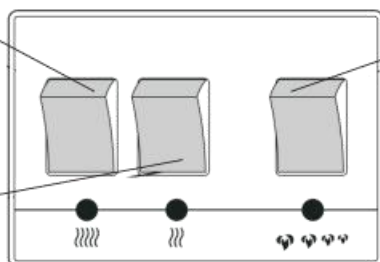

FLAME EFFECT

Press to change between the flame effects

MAIN POWER SWITCH

DISPLAY:

Weekday:

Shows current day, or currently selected day while setting the timer

T1 / T2:

Two periods of operation can be selected per day. The currently selected timer will be shown

HEATING LEVEL:

One bar indicated Low (1kw). Two bars indicates High (2kw)



DISPLAY:

Shows the room temperature, temperature set while changing desired temperature, or during setting the timer will show the on or off time (indicated by the On/Off lights)

AUTO:

Shows if the window detection function is active









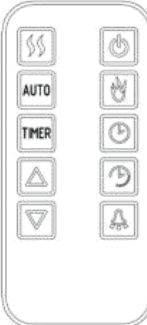

ON/OFF:

Shows whether it is the On or Off time for the timer which is been set

FLAME EFFECT

Indicates which flame effect has been selected

REMOTE CONTROL

Power Button		Press to turn the appliance On and Off.	
Flame Button		Press to cycle between the three flame effects.	
Arrow Buttons	 	Use to change the desired room temperature. The temperature currently selected will be displayed on the display	
Heating Level Button		Press to change between the available heating levels.	
Downlight		Press to turn the downlights On / Off.	
Timer On / Off		Press to turn the timer On/Off.	
Clock		<p>Before using the weekly timer, the clock must be set. To do this: Press the CLOCK button, then use the arrow buttons to select the day. Press CLOCK again, then use the arrow buttons to select the hour value (24 hour format) Press CLOCK again, then use the arrow buttons to select the minute value.</p>	
Week Timer		<p>Your fire includes a 7 day timer, which allows you to set two periods of operation per day. The fire will operate with the previously used settings for the heating level, desired temperature, and flame colour.</p> <p>To set the timer press the TIMER button. The unit will display the day, period, and if you are setting the On or Off time. For each Period both the On and Off times must be set.</p> <p>For each Period:</p> <ol style="list-style-type: none"> 1. Set the On hour value using the arrow buttons, press TIMER to confirm 2. Set the On minute value using the arrow buttons, press TIMER to confirm 3. Set the Off hour value using the arrow buttons, press TIMER to confirm 4. Set the Off minute value using the arrow buttons, press TIMER to confirm <p>The fire will then move onto the next period / first period of following day, allowing this to be programmed in the same way. The days and periods can be scrolled through by repeatedly pressing TIMER.</p> <p>To clear an operational period set the ON and OFF times to the same value.</p>	
Open Window Detection		<p>Your Fire includes "Open Window Detection" which will stop the heating function after a period of time if the room temperature is not increasing, on the assumption that there is an open door or window. This is designed to save energy and be turned on and off using the AUTO button. When the function has been activated, AUTO will flash on the screen.</p>	

CARE AND MAINTENANCE

When cleaning unit, the power supply should be disconnected and the unit should be cool.

Dust can be removed by lightly wiping the glass surface with clean, lint free cloth or paper towel. To remove fingerprints or other marks, use a damp cloth with a good quality household glass cleaner. The front glass panel should be completely dried before reusing the heater.

CAUTION:

- Do not use abrasive cleaner on glass panel.
- Do not spray liquids directly onto any surface of the unit.
- Do not clean the glass on the inside of the unit as this may cause damage to the surface.

REPLACING THE BATTERIES

The remote control takes a CR2025 battery. If the remote becomes unresponsive, please change the battery with a new battery, as shown in the image.

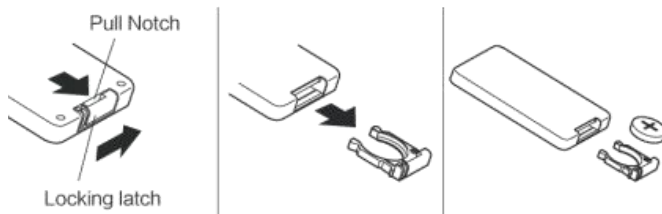

TROUBLESHOOTING

Most problems are simple to resolve - please refer to the following table before calling a service engineer:

Problem	Possible Cause	Check
Fire has stopped working	The fire has overheated and the thermal safety device has activated or a circuit breaker has tripped.	Check there is power to the socket where the fire is connected, check the fuse in the plug, check the main power switch on the unit is turned on and leave for 10 minutes in case of thermal cut-out.
Flame is not moving	Flame motor defective	Contact the retailer or manufacturer.

SERVICING

It is hazardous for anyone, other than a qualified service technician, to carry out any service or repair operation, which involves removal of any components. The lighting for the flame effect is by LED bulbs which are designed to last for the life of the product and are not user replaceable.

SUPPORT

For your own convenience, please make these simple checks before you contact us or other aid.

1. Check that the unit is plugged into the mains.
2. Check that the fuse is OK.
3. Switch the unit off and wait ten minutes to see if the issue is resolved. Restart the unit.

TECHNICAL SPECIFICATION

Description of Product	Electric Wall Hanging Fire
Model	PM0796
Rated Voltage	220-240V
Rated Frequency	50/60 Hz
Rated Power	Max 2000W
Dimensions (W)x(H) x (D)	1320 x 580 x210mm
Weight	24.15KG

WASTE ELECTRICAL RECYCLING

This symbol indicates that this product is classed as Electrical or Electronic Equipment and should not be disposed of with other household waste.



The Waste Electrical and Electrical Equipment (WEEE) Directive has been introduced across the European Union:

To recycle waste electrical products using the best available recovery and recycling techniques in order to minimize the impact on the environment.

To treat any hazardous substances and to avoid increasing landfill. WEEE product should be disposed of by handing it over at a designated collection point.

For more information about where you can drop off your waste product for recycling, please contact your local authority.

Item	Symbol	Value	Unit	Item	Unit
Heat Output				Type of heat input, for electric storage local space heaters only (select one)	
Nominal heat output	P_{nom}	2.0	kW	manual heat charge control, with integrated thermostat	No
Minimal heat output	P_{min}	1.0	kW	manual heat charge control with room and/or outdoor temperature feedback	No
Maximum continuous heat output	P_{max}	2.0	kW	electronic heat charge control with room and/or outdoor temperature feedback	No
Auxiliary electricity consumption				fan assisted heat output	No
At nominal heat output	e_{lmax}	1.898	kW	Type of heat output/room temperature control (select one)	
At minimum heat output	e_{lmin}	0.990	kW	single stage heat output and no room temperature control	No
In standby mode	e_{lsb}	0.00043	kW	two or more manual stages, no room temperature control	No
				with mechanical thermostat room temperature control	No
				with electronic room temperature control	No
				with electronic room temperature control plus day timer	No
				with electronic room temperature control plus week timer	Yes
				Other control options (multiple selections possible)	
				room temperature control with presence detection	No
				room temperature control, with open window detection	Yes
				with distance control option	No
				with adaptive start control	No
				with working time limitation	Yes
				with black bulb sensor	No
Contact Details					