

ASSEMBLY INSTRUCTION

Step 3

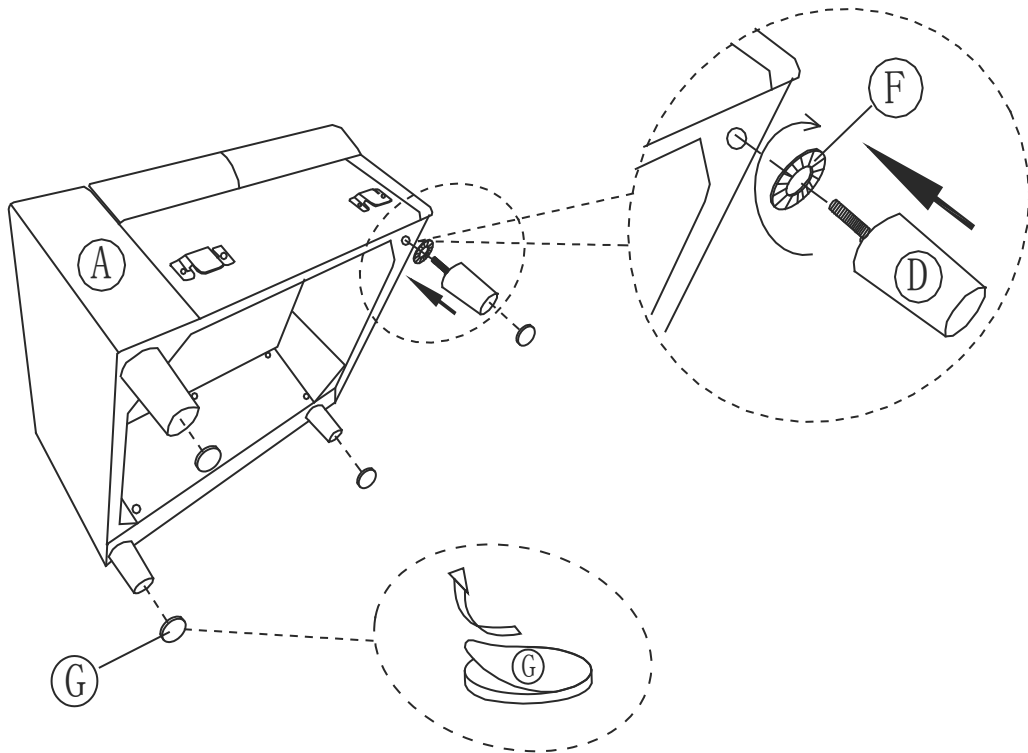

Step 4

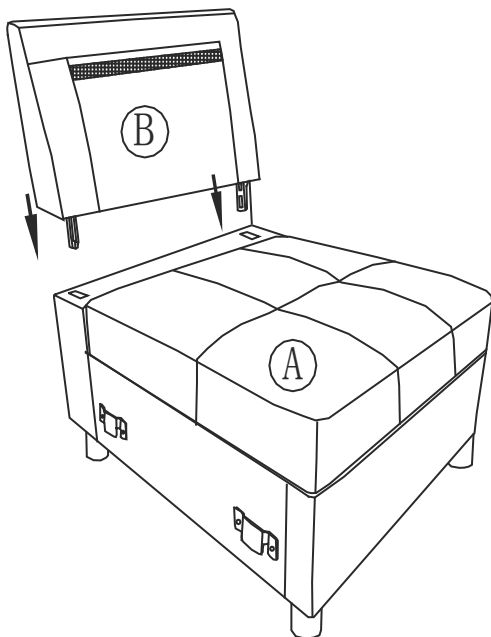

Step 5

