









Thank You For Shopping With COZAYH HOME

We value your feedback and want to hear from you. To let us know how we can improve your shopping experience, or to ask a specific question about your order, please find our contact information below.

Customer Service Line: 1.312.600.5553 (M-F 9am-5pm Central Time)

Customer Service Email: Support@cozayh.com

Website: www.cozayhome.com

SKU: Z02053		Assembly Instructions									
		Laying out all the parts and hardware and identifying each part as shown may help you when you assemble the table.									
ITEM	PART	DESC.	QTY	ITEM	PART	DESC.	QTY	ITEM	PART	DESC.	QTY
A		Top Panel	1	D		Back Panel	1	G		Washer	6
B		Frame	1	E		Legs	4	H		Bolt (6"30mm)	6
C		Shelf Panel	1	F		Allen Wrench	1	Note: Do NOT fully tighten any screw until all components are properly attached.			

STEP 1

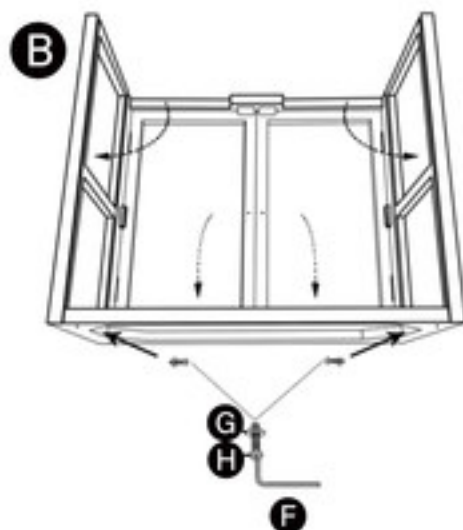

Unfold and secure the bottom panel to the sides.



WARNING

- Do not dispose of any packaging or contents of the shipping carton until assembly is completed to avoid accidentally discarding small parts or hardware.
- Choking Hazard - Adult assembly required. It may contain small parts and sharp points.
- Do NOT use power tools.
- This product can hold a maximum load of 50 Lbs. Do NOT overload.



COZAYH HOME

STEP 2

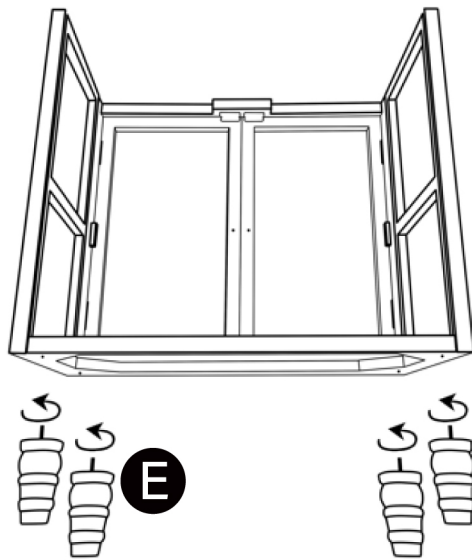

Screw in the legs.

STEP 3

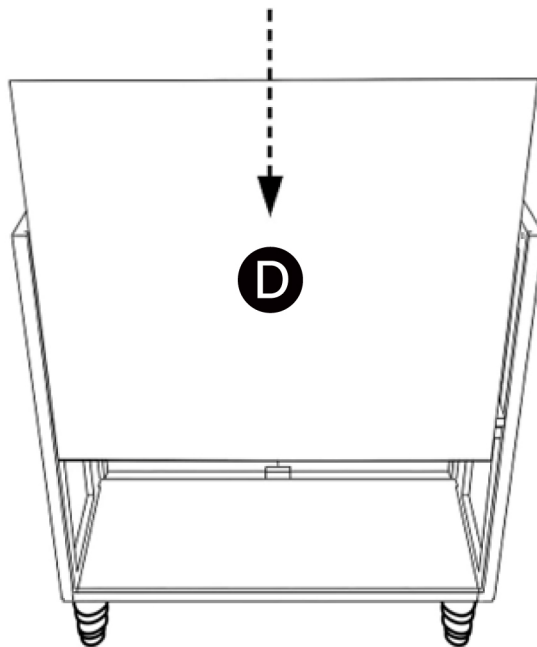

Tuck in the back panel.

STEP 4

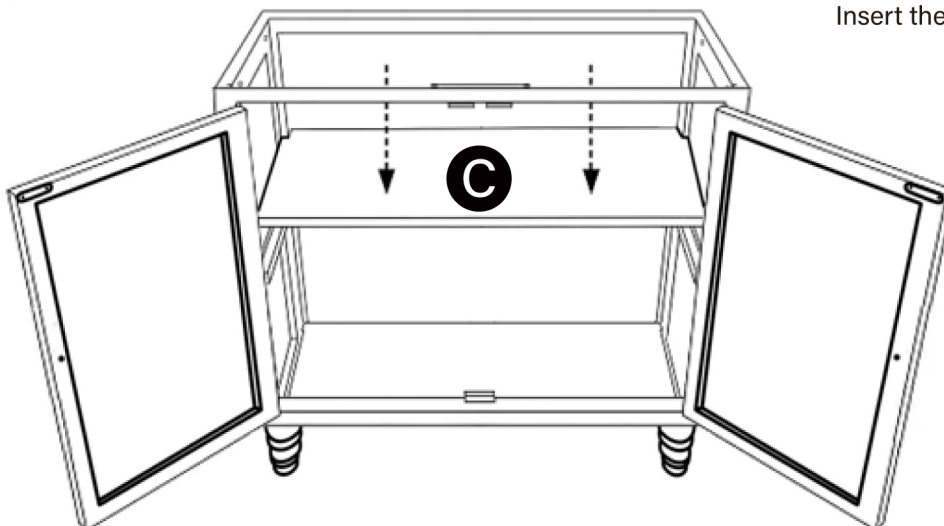

Insert the shelf panel.

STEP 5

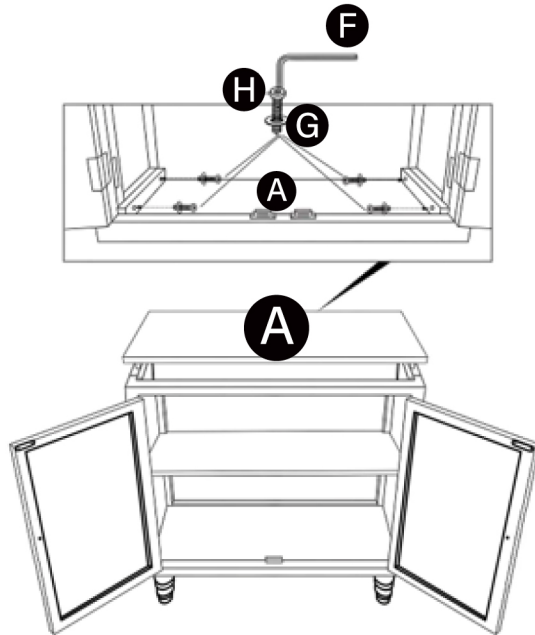

Attach the top panel to cabinet assembly.

STEP 6



Finished.