







ASSEMBLY INSTRUCTIONS

Description : Wing Chair

NO	Parts List	Q'TY
1	CHAIR FRAME WITH CUSHION SEAT 	1PC
2	FRONT LEG 	2PCS
3	REAR LEG (L&R) 	2PCS

NO	Hardware List	Q'TY
A	BOLT  Ø1/4" * 50 mm	8 PCS
B	LOCK WASHER  Ø1/4" * 11* 1.5 mm	8 PCS
C	WASHER  Ø1/4" * 22 *2 mm	8 PCS
D	ALLEN KEY  58 * 4mm	1PC

STEP 1

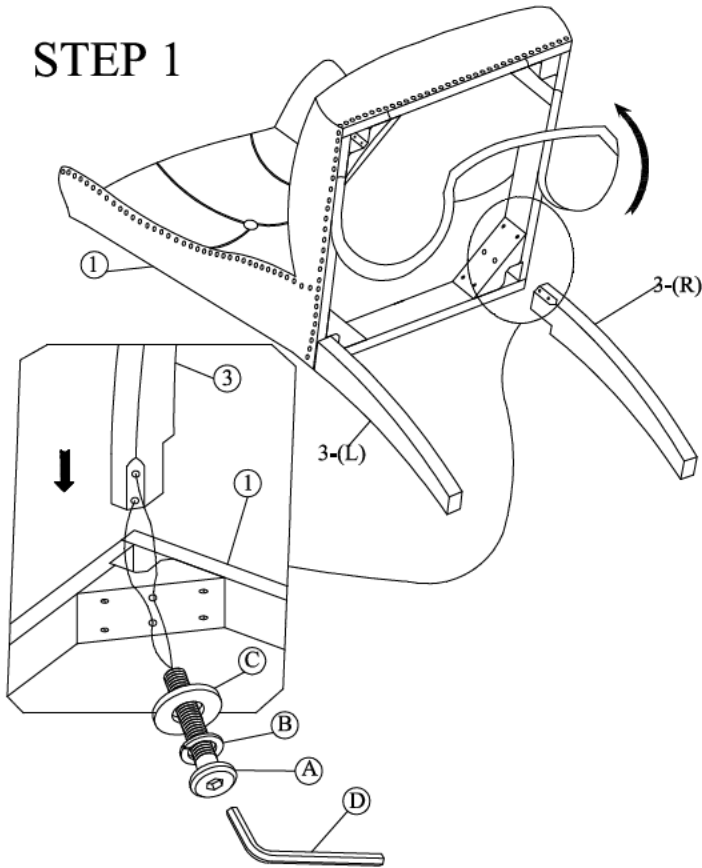

STEP 2

Noted: the legs need to adjust 90° when assembly.

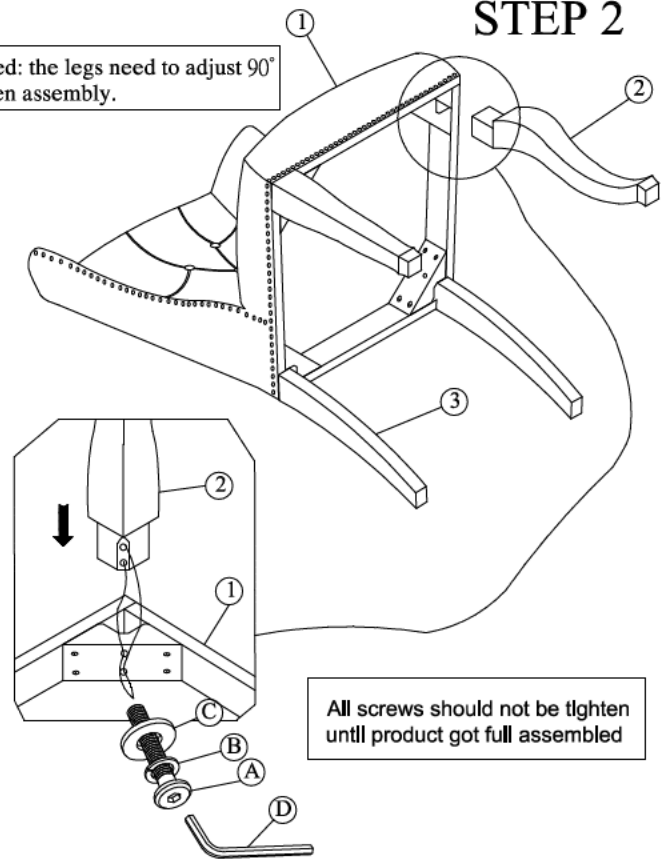

All screws should not be tighten until product got full assembled

STEP 2

