

ASSEMBLY INSTRUCTIONS

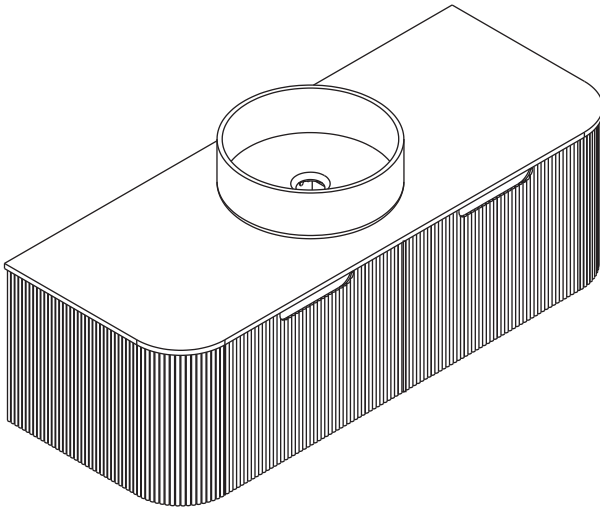

Bathroom Vanity

Notice:

1. Follow the installation instructions. Please confirm all accessories are preset before installation.
2. Do not fully tighten the screws during initial assembly. Fully tighten screws only once all pieces which are correctly assembled.
3. If you encounter any problems during installation, please contact our customer service.
4. Please unbox the item from the side with an open-label and put a carpet on the floor to avoid scratching it.





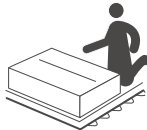

Recommended installers : 2



Put a carpet on the floor before unpacking

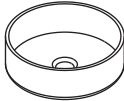

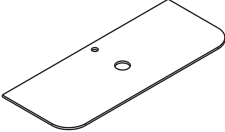
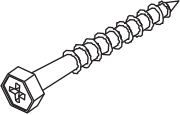
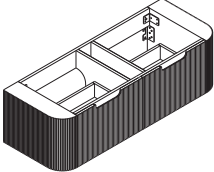
Estimate installation time:
30 minutes

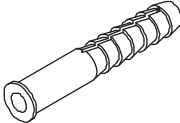
Item no.	Reference Image	Qty	Item no.	Reference Image	Qty
A		x1	2		x4
B		x1	3		x4
C		x1	4		x6
1		x4			

1

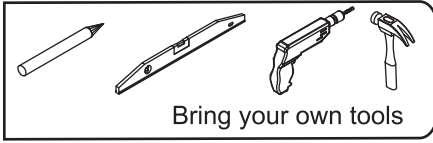
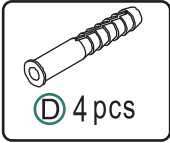

Solid color cabinet hanging
hole size

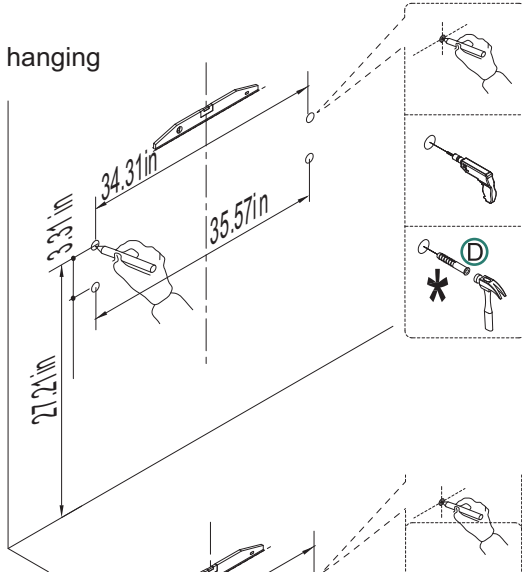

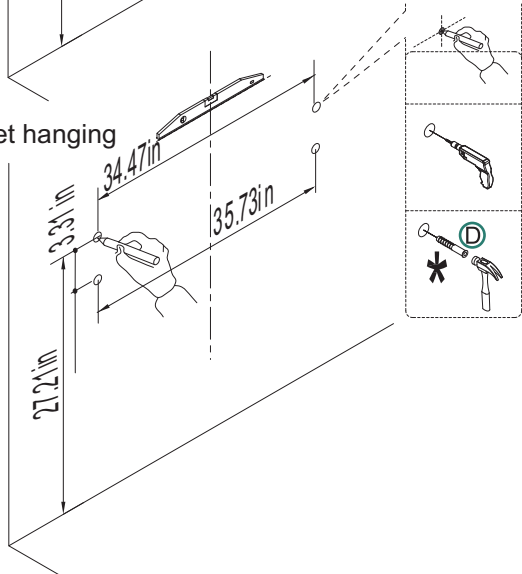

Wood grain cabinet hanging
wall hole size

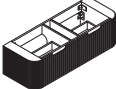

WARNING: To prevent tipping over, this product must be used with the included wall mounting device.
WARNING: Evaluate the suitability of the wall to ensure that the fixtures can withstand the forces that occur.

2

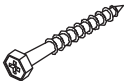
 ① 1pc
 ② 4pcs
 ③ 4pcs

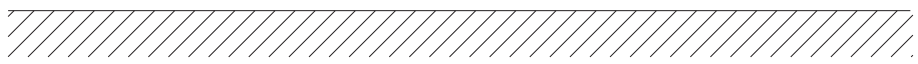
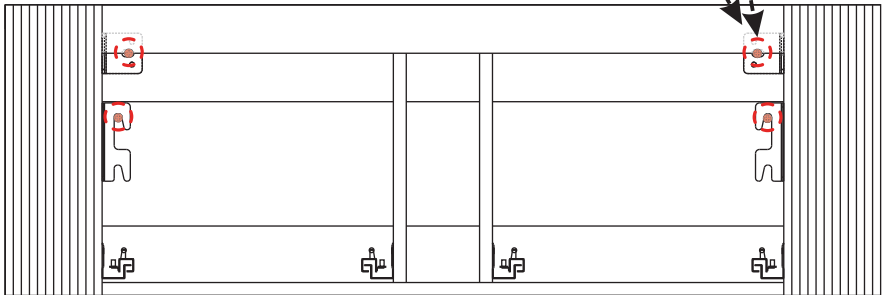
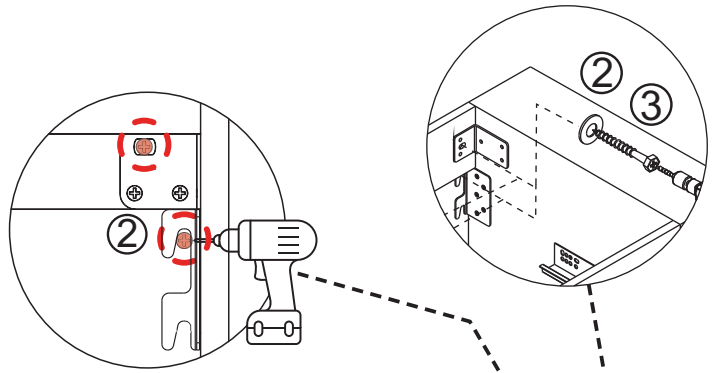

3

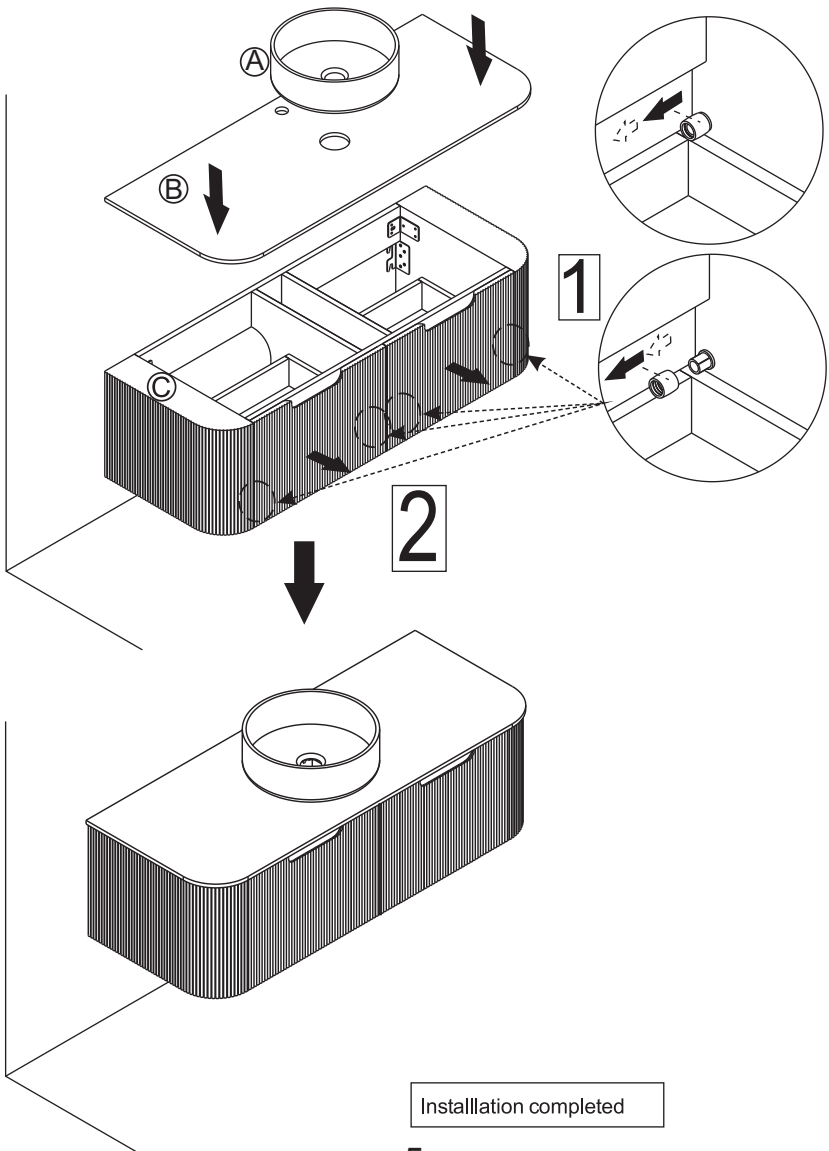
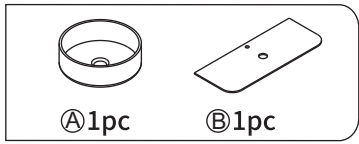

Installation completed

4

Installation of drain assembly

Turn the screw at the bottom of the guide rail counterclockwise!

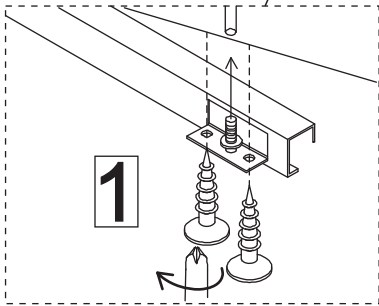
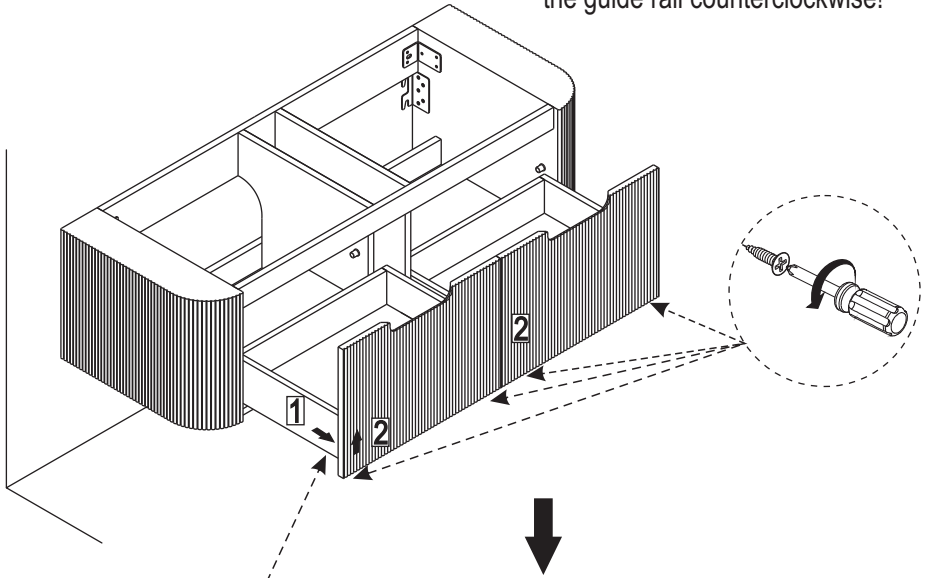

Move out the drawer

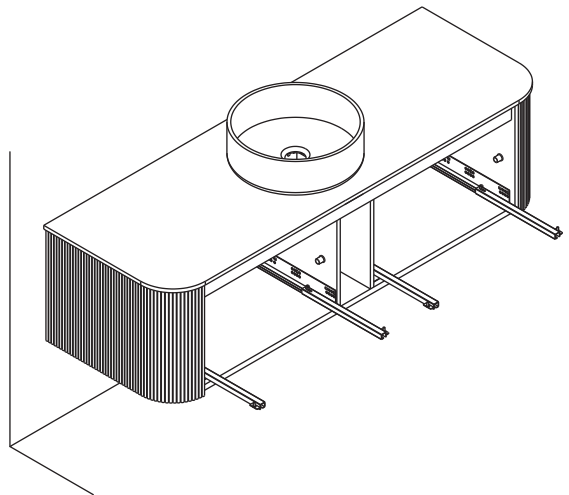

5

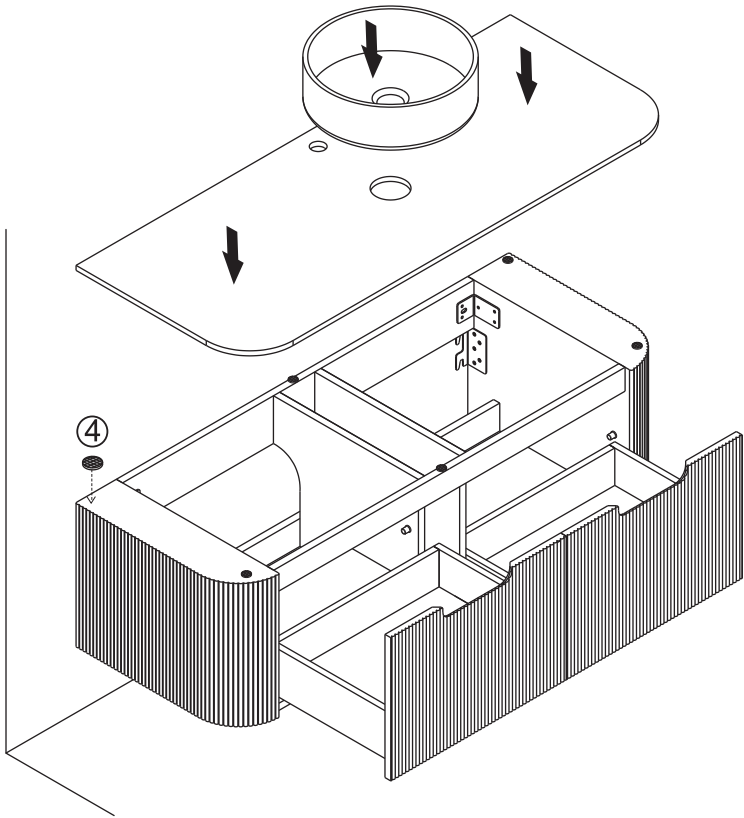
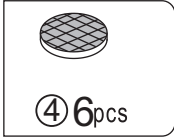

Installation of drain assembly

6

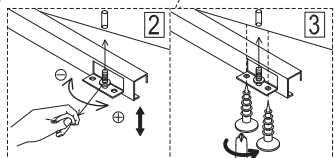
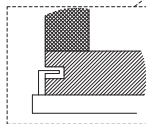
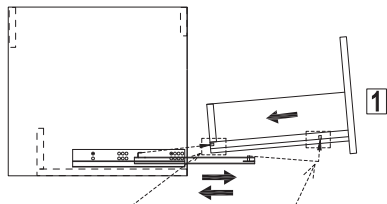
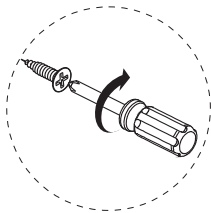
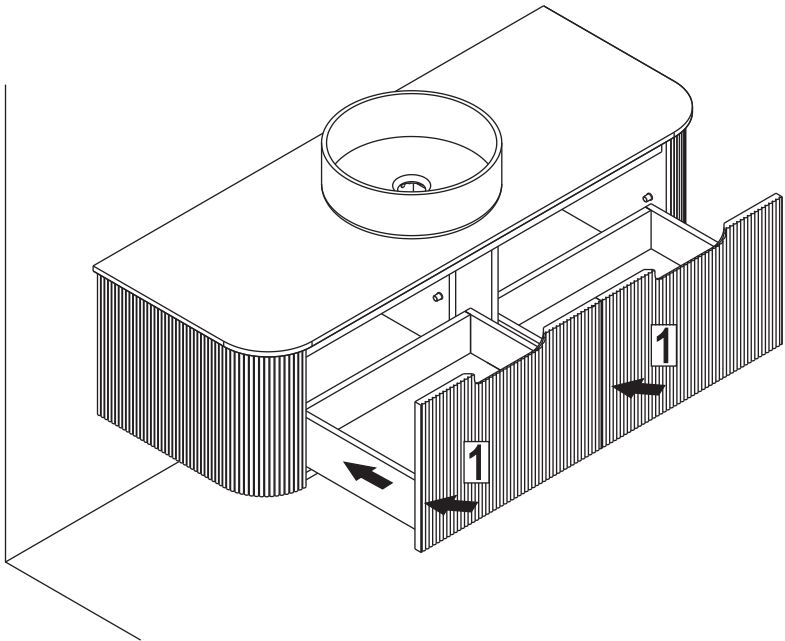

Installation completed