

Owner Manual

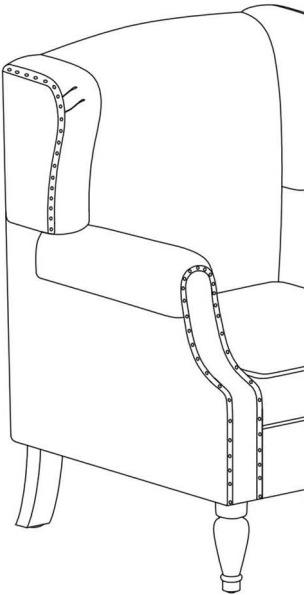

WARRANTY

We strive to offer high quality product and we also try our best to satisfy each customer that order from us, no matter on products or services as needed. Each customer receives a record of their order, such as the order number or item receipt. For any items that are out of warranty period, you may still be able to purchase the replacement parts from our company if they are available.



MAINTENANCE AND WARNING

Please read the manual thoroughly
before you start installing.

Please keep the product away from
sharp object.

Packaging and small parts may have
chocking hazard, please keep them away
from children and pets.

Please clean the product according to each
clean code, check the product description
for more information.

Please keep the product away from
fire.

If you have any other questions, please
contact us, we will be glad to help you out.

If the product is placed under direct
sunlight, the pattern or color might fade
away overtime.

Check the product periodically to make
sure everything is secured and tightened.

Always use proper tools for installation.

Do not jump on the product.

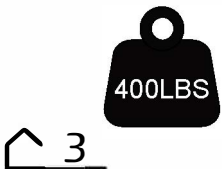

PRODUCT DESCRIPTION



Ergonomic backrest provides unparalleled support, perfectly fit your body outline, relaxing ur back while you use this chair.

The four chair legs are constructed from solid wood, ensuring durability and longevity.

This chair is upholstered in high-quality leather / linen, making it a timeless fashion piece.

This accent chair features a classic wingback silhouette with brass nailhead trim, embodying a cherished French country style.

The round arms and high back further enhance the chair's distinctive design.

EXPLODED VIEW

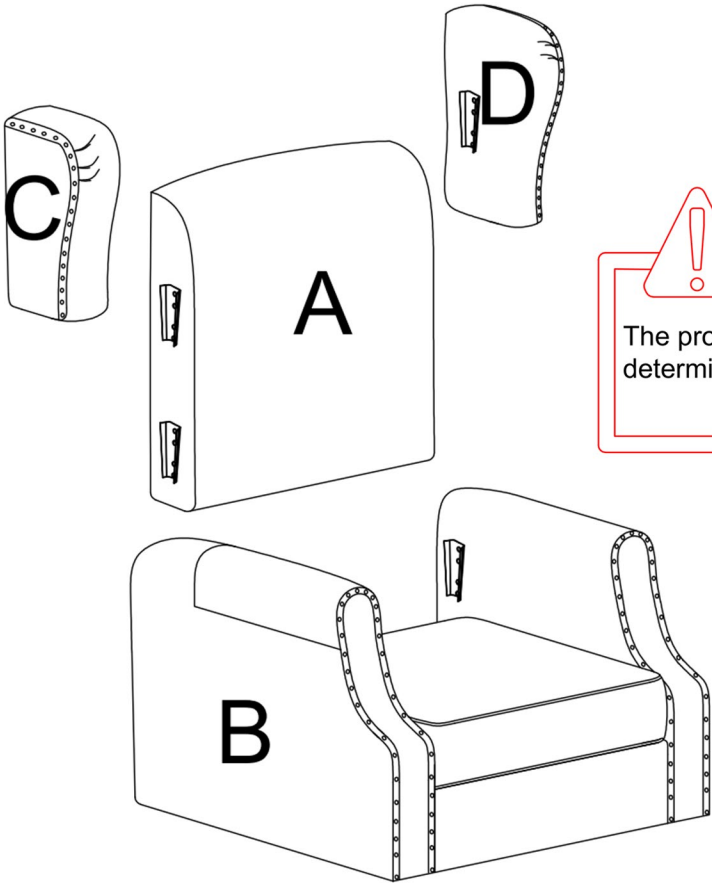

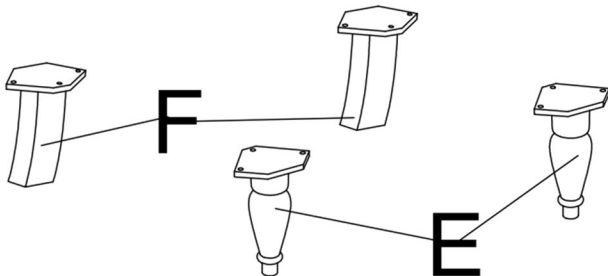

The product's left and right are determined by sitting posture

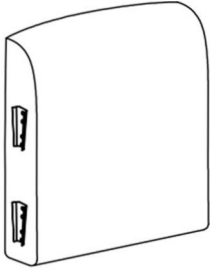

PARTS

A*1



Back

B*1

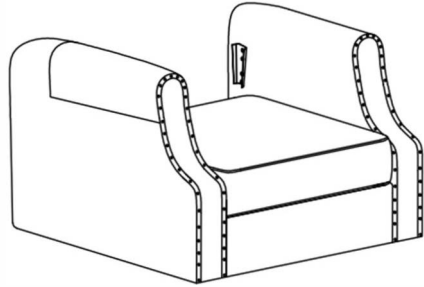

Seat frame

C*1



Right wing

D*1



Left wing

E*2



Front legs

F*2



Rear legs

HARDWARE

TOOL LIST

NOTE: Designated with (★) We provide additional spare parts in the hardware package

G*12

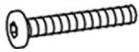

★ Bolts

H*1



Allen key

Please make sure all hardware & packing material fitting the list. Especially some small accessories may be missing during transportation. Please contact us if you have any question.

step 1

Flip over the chair and place it on a clean surface, then unzip the bottom part to take out both parts (C&D).

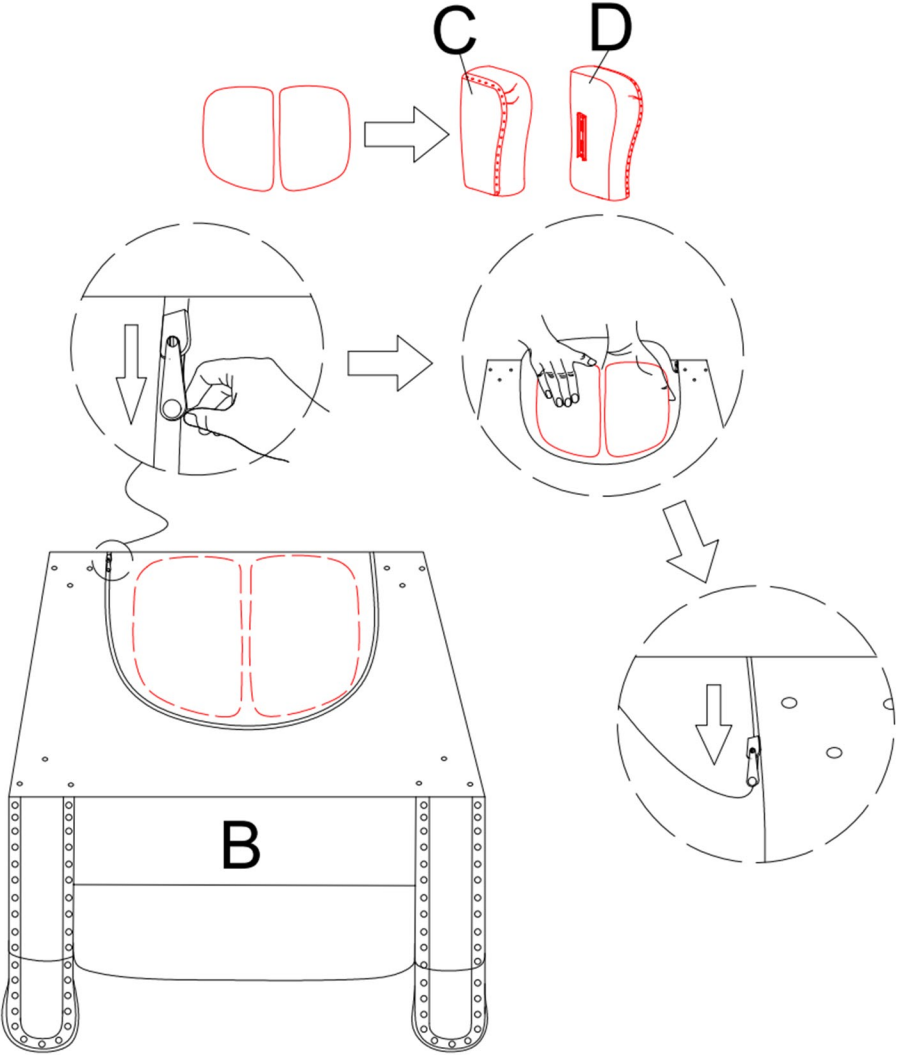

step 2

Connect legs (E&F) to the seat frame (B) by using the bolts (G) and use allen key (H) to tighten the bolts. Make sure all the bolts are fully tightened before next step.

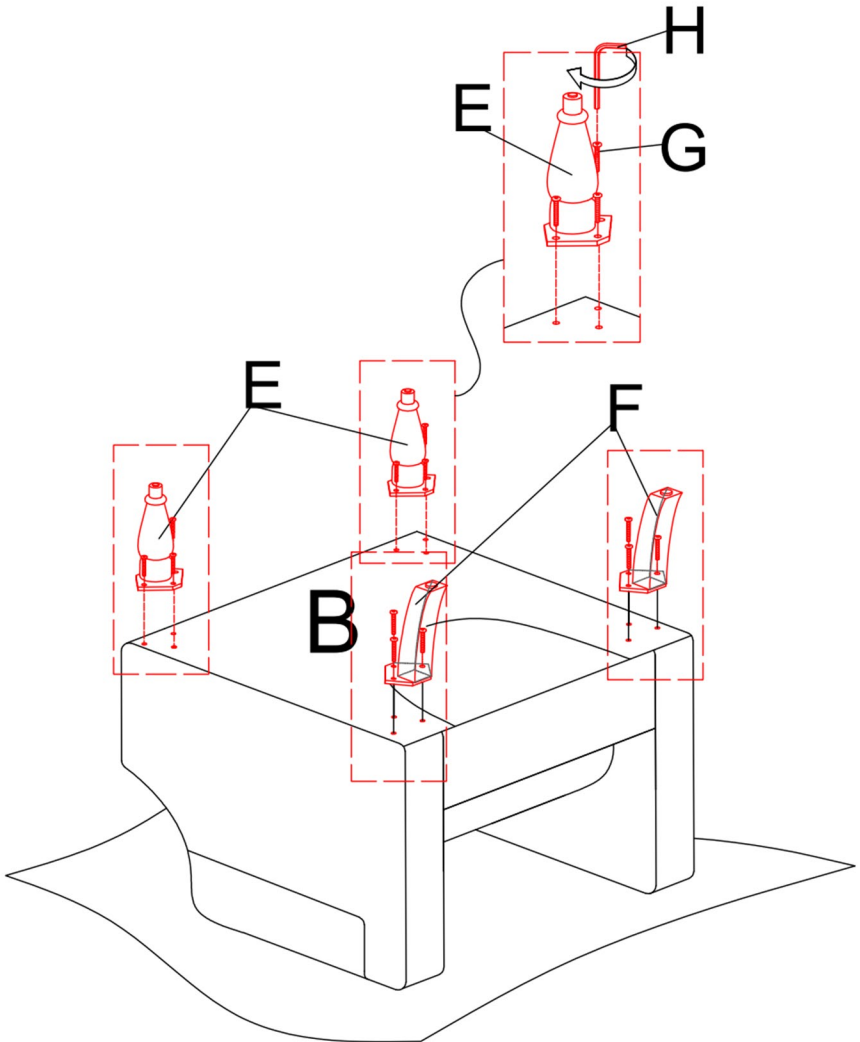

step 3

To assemble the Backrest and the Seat frame, place the backrest between the two armrests. Align the metal connectors at the lower sides of the backrest with the corresponding metal connectors on the inner sides of the armrests, then press firmly on the top of the backrest to ensure the metal connectors are fully inserted. If there is a visible gap between the backrest and the Seat frame, apply pressure on the top of the backrest or place a book or wooden block on either side of the top and tap gently with a hammer to fully secure the connectors.



If the distance between the armrests is too tight or too loose, making insertion difficult, gently push the armrests apart or pull them closer together to adjust. This is a common variation in handcrafted products and not a quality issue.



During installation, handle with care to prevent the metal connectors from damaging the fabric.

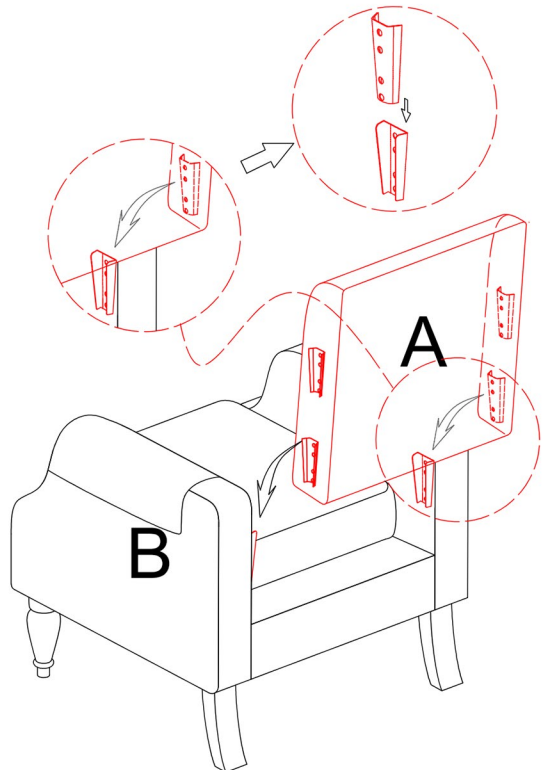

step 4

To install the wings on both sides of the backrest, align the metal connectors on the inner side of each wing with the corresponding connectors on the upper sides of the backrest. Press horizontally toward the backrest while simultaneously pressing down on the top of the wing to ensure the connectors fully insert into place.

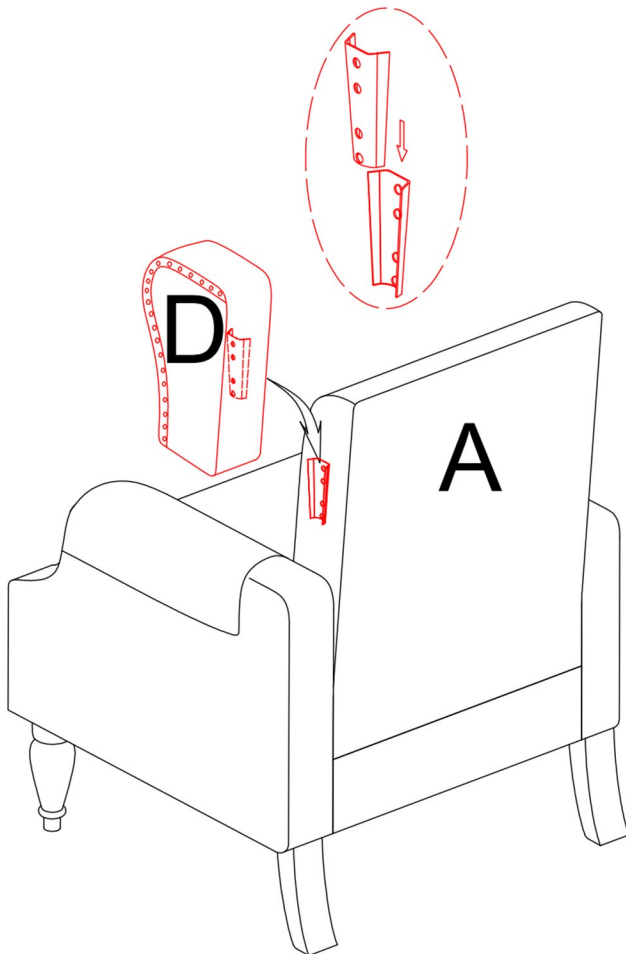

step 5

Install the right wing (C) to the backrest (A) by sliding the connector into the slot on back as shown, simultaneously press down from the top of wing until it is fully assembled.

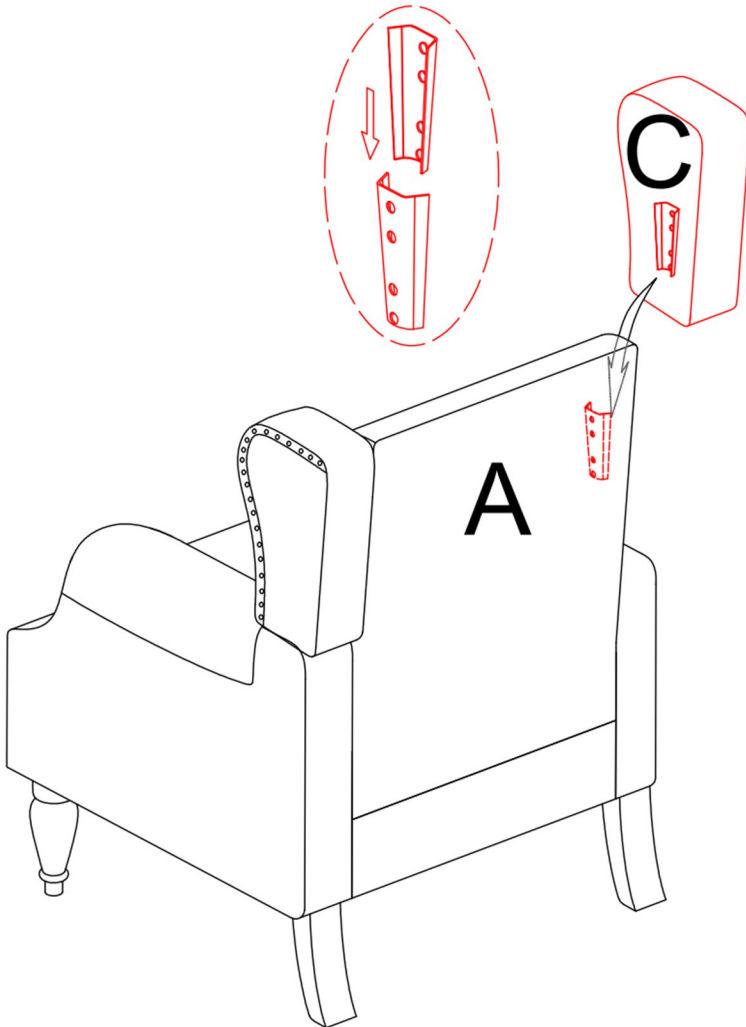

step 6

Please note: the legs of the chair can be adjusted by twisting the leveler on the tip of the legs as shown, it can help you use this chair on ground that is not flat, please check before you use the chair.

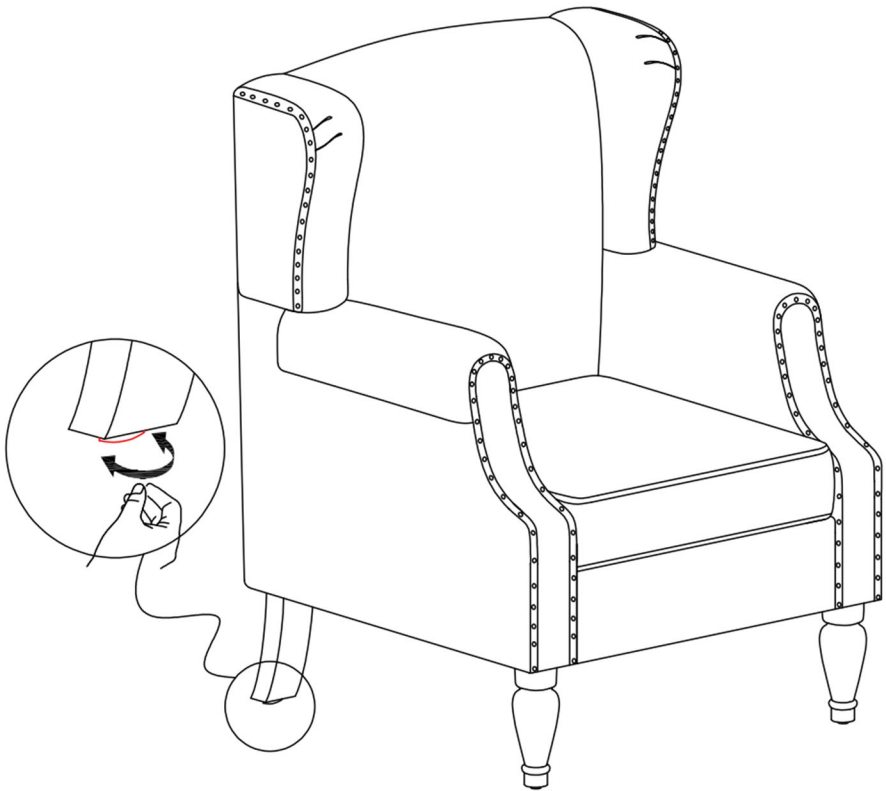

step 7

Congratulations! You have finished the installation! Thank you so much for choosing our product! Please enjoy!

