

# KINGSTON FAUCETURE

## LED Mirror with Touch Switch Installation Instructions

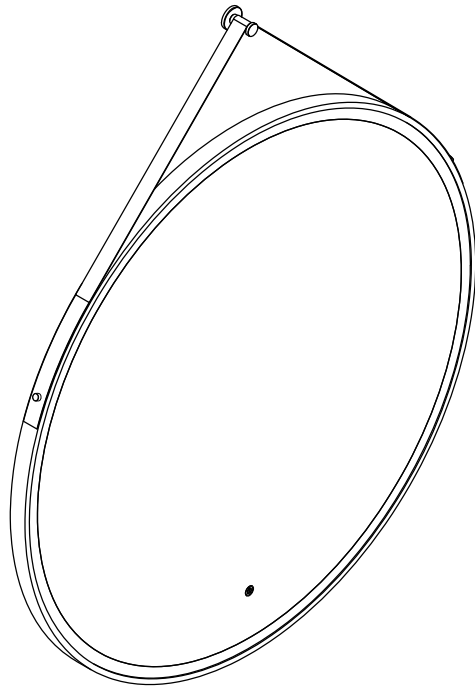

[www.kingstonbrass.com](http://www.kingstonbrass.com)

TOLL-FREE CUSTOMER SERVICE: 1-877-2-KBRASS  
TECHNICAL SUPPORT E-mail: [service@kingstonbrass.com](mailto:service@kingstonbrass.com)  
12775 Reservoir Street, Chino, CA 91710

**CAUTION**

Failure to follow all installation directions may cause product to detach from the wall and cause serious injury

**DANGER**

Hazardous voltage (120v).  
Contact may cause electrical shock and injury.  
Disconnect power before servicing  
This equipment is to be serviced by trained personnel only

## Read Before Installation

Unpack your LED mirror with touch switch and verify that all components are included in the box. The mirror glass is fragile; keep all packing materials in place and rest the mirror on a soft surface. Do not place the mirror on a hard surface.

## Warning

- It is recommended that this mirror be installed by a qualified, licensed contractor.
- Read and follow all instructions before installing or using this mirror.
- To reduce the risk of burns, fire, electric shock, or injury to persons, use this mirror only for its intended purpose as described in these instructions. Do not use attachments not recommended by the manufacturer. Never drop or insert any object into any opening. Do not use outdoors.
- This mirror is designed to be plugged into a 120VAC, 20 AMP GFCI (Ground Fault Circuit Interrupter) electrical outlet. All electrical work should be performed by a licensed electrical contractor. The power source must be disconnected prior to servicing this mirror.

## Tools Required for Assembly

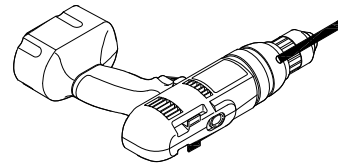

Electrical Drill

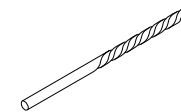

1/8" Drill Bit

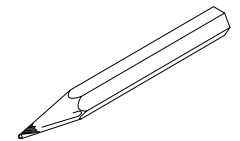

Pencil

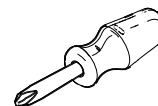

Phillips  
Screwdriver

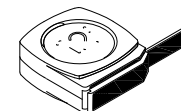

Tape Measure

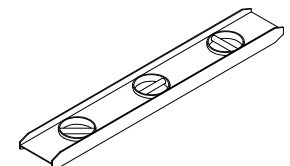

Level

## Parts Included



SCREW (x4)



WALL PLUG (x7)

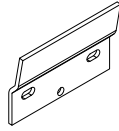

WALL HANGER (x2)

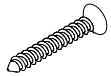

SCREW (x3)



SCREW (x2)

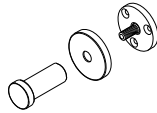

HANGING BAR (x1)

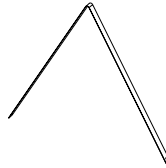

HANGING STRIP (x1)

**NOTE:** Determine overall mirror dimensions before proceeding to installation.

※ All dimensions & specifications are approximate and subject to change without notice.

## MIRROR FEATURES

- Copper free silver mirror
- High output LED lighting:  
CRI 90+, 2700-6500K CCT, IP44
- Color Temperature changing touch switch for surface LED
- Defogger

## Electric wiring

Be sure to provide enough wire to make the proper and safe connection to the Field/Power.

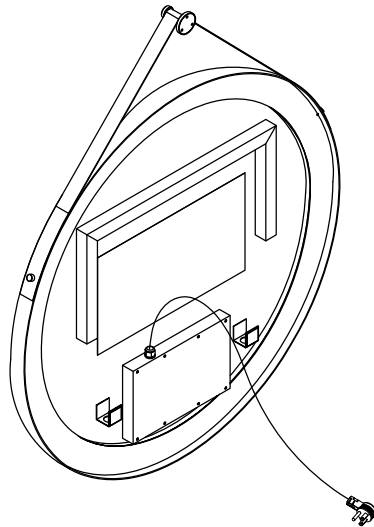

2.

## Installation Instructions

- 1 Determine the desired location for the mirror. Using a pencil, mark a horizontal line where the top of the mirror frame will be placed, and also mark a centerline. Insert the wall hangers into the slots on the back of the mirror frame.

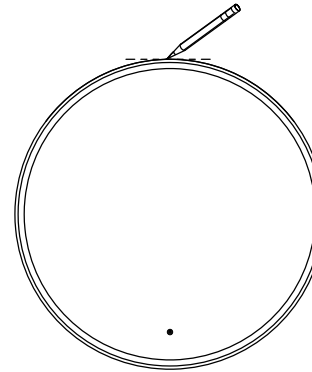

- 2 Measure the distance from the top of the mirror frame to the center of the holes on the wall hanger, as well as the horizontal measurement from outer edge to outer edge of the wall hangers.

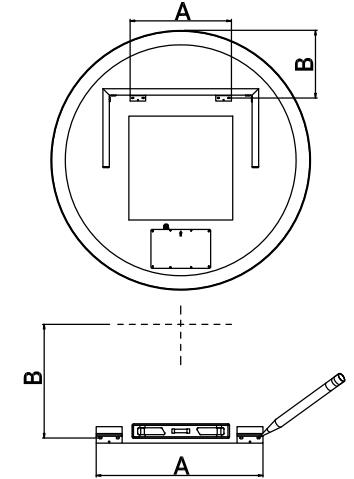

- 3 Using these measurements, place the wall hangers at the designated location, mark the hole locations, drill 1/8" holes, and tap the anchors into the wall. Thread the enclosed screws into the wall anchors to secure the wall hanger.

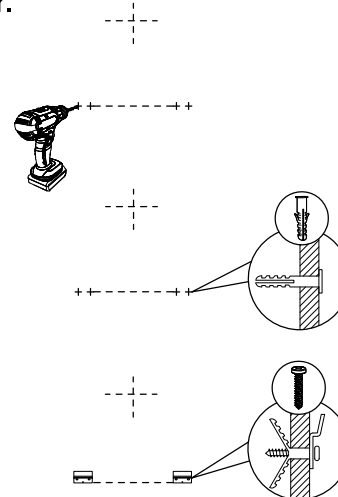

- 4 Hang the mirror onto the wall hangers. Plug the cord into the outlet.

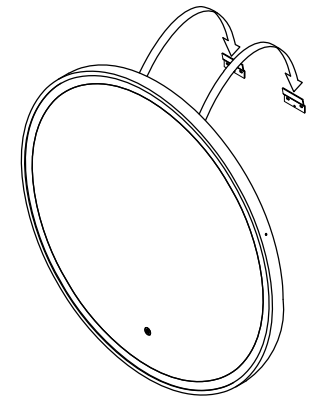

3.

# Installation Instructions

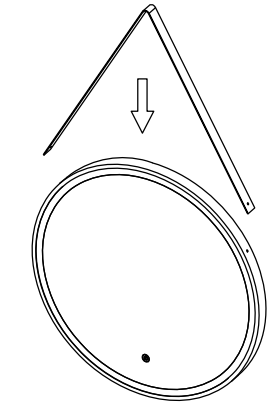
**5** 

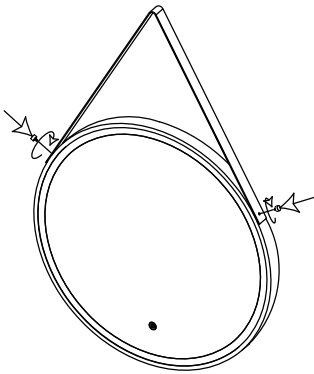
**6** 

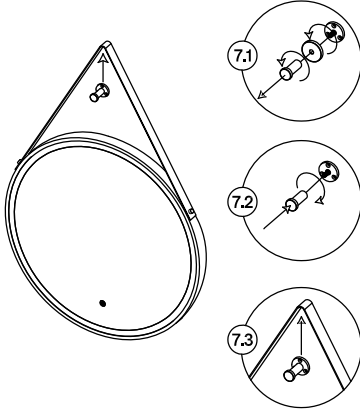
**7** 

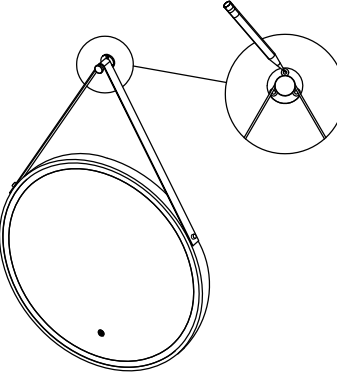
**8** 

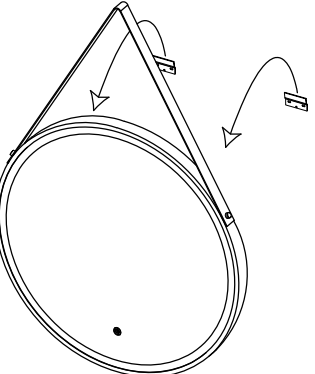
**9** 

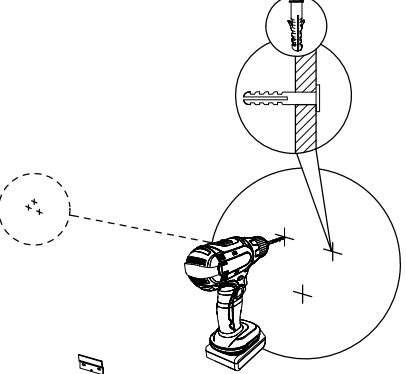
**10** 

# Installation Instructions

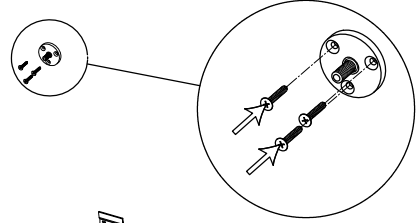
**11** 

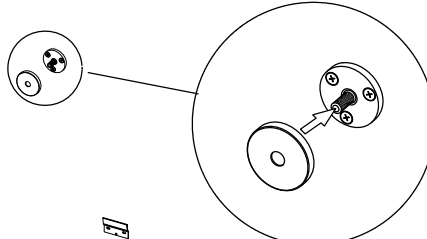
**12** 

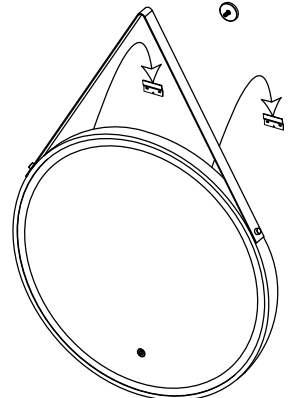
**13** 

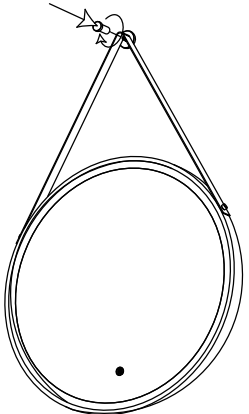

**14** 

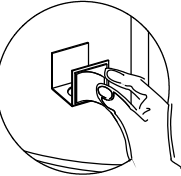
**15** Clean the wall behind the mirror. Remove the plastic cover from the adhesive spacer blocks on the back of the mirror and gently press them into place.



# Final Assembly

## ■ How to use Defogger Switch and Dimmer Switch

- Press the icon  shortly to control on / off the lighting and heating pad.
- Press and hold the icon  to change the color temperature.
- Press and Hold the icon  again to change the brightness.
- The heating pad closes automatically within one hour

# Use and Maintenance

## ■ Warnings

1. Please do not use if you found the mirror has been broken.
2. Never put any sharp or heavy material on the mirror surface, other wise the glass mirror will be broken and body injury accidents may occur.
3. Turn off the power switch in storm lightning weather to avoid electric parts damage.

## ■ CAUTION

### ● Use

	To avoid damage, do NOT knock the mirror cabinet with any hard objects.
---	---

### ● Cleaning

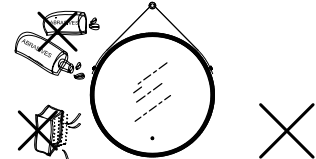
	Do NOT clean the mirror cabinet with caustic cleaner. Do NOT wipe the mirror cabinet with Bristle brush.
---	---

### ● Maintenance

	For daily maintenance, please use soft cloth and mild cleaner to clean the mirror cabinet.
---	--